

LEGEND

- ① HUNTER POP-UP BODY
PROS-03: NOZZLE AND CAP PER
PLAN
- ② FINISHED GRADE
- ③ ADJACENT LANDSCAPE
- ④ LATERAL PIPE PER PLAN
- ⑤ LATERAL FITTING PER PLAN
- ⑥ HUNTER SWING JOINT (PER
PLAN)

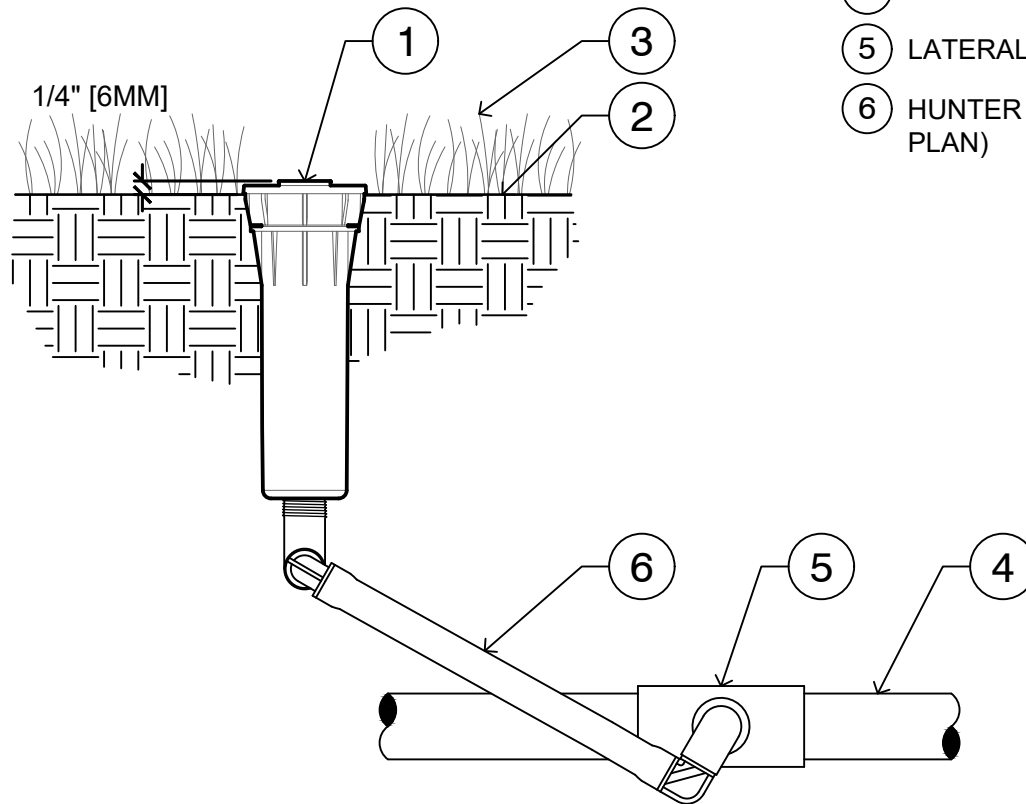

**POP-UP BODY (PROS-03)
WITH HUNTER SWING JOINT**

00

N.T.S.