

HCC & HCC-FPUP

HYDRAWISE READY CONTROLLER QUICK START GUIDE

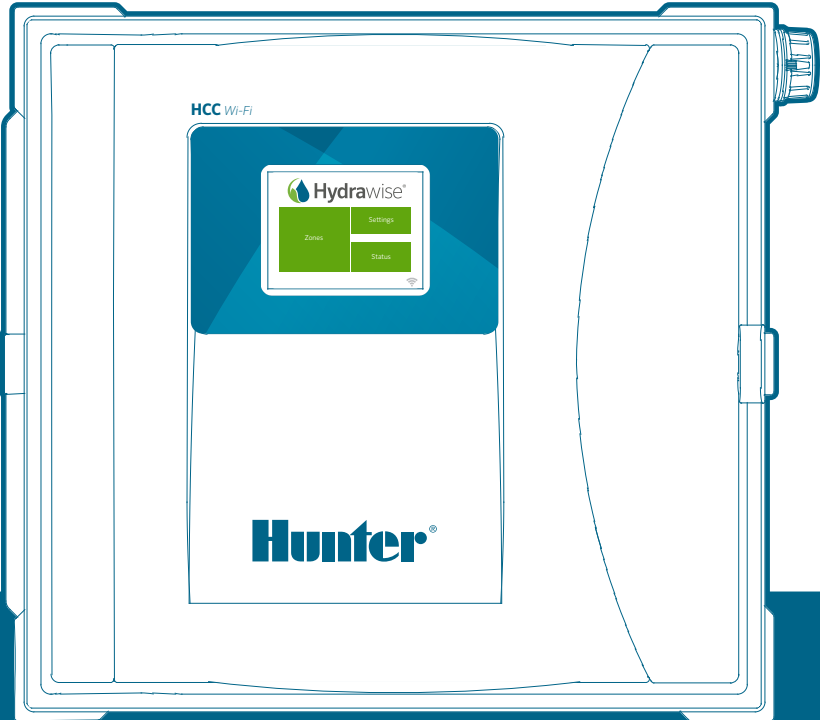

The Most Complete
Wi-Fi Irrigation Control System



Table of Contents

3	Thank You for Purchasing a Hydrawise® Ready Irrigation Controller
6	Mount Your Controller
8	Install Your Controller
10	Wiring Your Controller
10	Earth Ground Connection (Lightning Protection)
12	120 V and 230 V Connections
14	Power Module Terminals
16	Station Module
16	Solenoid Valves
18	Retrofit Your ICC or ICC2 Controller to a Hydrawise Ready Controller
22	Configure Your Controller Offline
25	Basics of Your Touchscreen Controller
25	Home Screen Navigation
27	Connect Your Controller to the Internet
27	Using the Connection Wizard
30	Notices
30	U.S. FCC Statement
30	Certificate of Conformity to European Directives
31	Innovation, Science and Economic Development Canada (ISED) Compliance Notice
31	Déclaration d'Industrie Canada

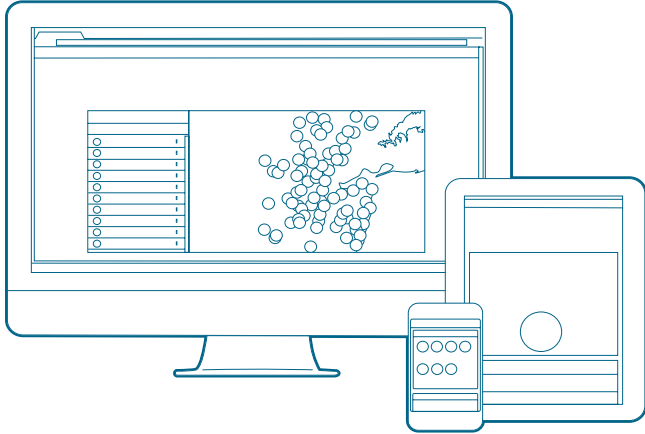

150' (45 m)

Your Hydrawise controller can connect to the internet via your Wi-Fi router and is then available for you to use through your smart devices (phone, tablet) and your computer. Visit hydrawise.com to get started.

Need more helpful information on your product? Find tips on installation, controller programming, and more.



Important:

Typical Wi-Fi range covers 150' to 200' (45 to 61 m). Be sure to install the controller within suitable range of your network router.



hunter.help/Hydrawise

Thank You for Purchasing a Hydrowise Ready Irrigation Controller

DE Vielen Dank, dass Sie sich für das Hydrowise Ready Steuergerät entschieden haben

Das Hydrowise Steuergerät kann sich mit Ihrem Wi-Fi-Router verbinden und ist somit direkt über Ihr Smart-Device (Smartphone, Tablet) oder Ihren Computer steuerbar. Besuchen Sie uns auf hydrowise.com und legen Sie los!

Wünschen Sie weitere hilfreiche Informationen zu Ihrem Produkt? Hier finden Sie Tipps zur Installation, Programmieranweisungen und weiteres.

! Wichtig: Die reguläre Reichweite eines Wi-Fi Netzes deckt 45 bis 61 m ab. Achten Sie darauf, das Steuergerät innerhalb einer geeigneten Reichweite zum Router zu installieren.

🔗 support.hydrowise.com

ES Gracias por comprar un programador de riego compatible con Hydrowise

Su programador Hydrowise puede conectarse a Internet por medio de su router Wi-Fi, y estará disponible para controlarlo a través de sus dispositivos inteligentes (teléfono o tableta) y su ordenador. Visite hydrowise.com para comenzar.

¿Necesita más información sobre el producto?

Encuentre consejos de instalación, programación y más.

! Importante: El rango habitual de Wi-Fi cubre de 45 a 61 m (150 a 200 pies). Asegúrese de instalar el programador dentro del rango adecuado del router.

🔗 support.hydrowise.com

FR Merci d'avoir acheté un programmeur d'arrosage compatible Hydrowise

Connectez votre programmeur Hydrowise à Internet via votre routeur Wi-Fi, après quoi vous pourrez l'utiliser avec vos appareils mobiles (téléphone, tablette) et votre ordinateur. Rendez-vous sur hydrowise.com pour commencer.

Vous avez besoin d'informations supplémentaires sur votre produit ? Découvrez des conseils sur l'installation, la configuration des programmeurs et bien plus encore.

! Important : Une portée Wi-Fi habituelle couvre de 45 à 61 m.

Assurez-vous d'installer le programmeur à une portée adéquate du routeur.

🔗 support.hydrowise.com

IT Grazie per aver acquistato un programmatore di irrigazione Hunter predisposto per Hydrowise

Il controller Hydrowise può connettersi a internet tramite il router Wi-Fi e quindi è disponibile per l'utilizzo attraverso il tuo dispositivo smart (telefono, tablet) e il computer. Visita hydrowise.com per iniziare.

Avete bisogno di informazioni più utili sul vostro prodotto?

Ricevete suggerimenti sull'installazione, sulla programmazione del programmatore e molto altro ancora.

! Importante: Il Wi-Fi, normalmente, copre una distanza compresa tra 45 e 61 m. Assicuratevi di installare il programmatore nell'area coperta dal router.

🔗 support.hydrowise.com

PT Obrigado por adquirir um controlador de irrigação com o Hydrowise

Seu controlador Hydrowise pode ser conectado à internet através do seu roteador Wi-Fi. Assim, você pode acessá-lo do seu celular, tablete ou computador. Acesse hydrowise.com e comece já.

Deseja mais informações sobre seu produto? Confira dicas de instalação, programação de controladores e muito mais.

! Importante: O alcance típico do Wi-Fi é de 45 a 61 metros. Lembre-se de instalar o controlador dentro do raio de alcance do roteador.

🔗 support.hydrowise.com

RU Благодарим вас за покупку контроллера полива, совместимого с Hydrowise

Ваш контроллер Hydrowise можно подключить к Интернету через Wi-Fi-маршрутизатор для получения доступа к контроллеру с помощью смарт-устройств (телефона, планшета) и компьютера. Посетите hydrowise.com, чтобы начать работу.

Нужна более подробная информация о вашем продукте? Здесь вы найдете советы по установке и программированию контроллера, а также многое другое.

Важно! Обычно радиус действия Wi-Fi составляет от 45 до 61 м. Убедитесь, что контроллер установлен в пределах зоны действия маршрутизатора.

🔗 support.hydrowise.com

TR Hydrowise yazılımlı sulama kontrol ünitesi satın aldığınız için teşekkür ederiz

Hydrowise kontrol üniteniz Wi-Fi yönlendiriciniz üzerinden İnternet'e bağlanabilir ve ardından kontrol ünitesini akıllı cihazlarınız (telefon, tablet) ve bilgisayarınız aracılığıyla kullanabilirsiniz.

Başlamak için hydrowise.com adresini ziyaret edin.

Ürününüz hakkında daha çok faydalı bilgiye ulaşmak ister misiniz?

Kontrol ünitesi programlama, kurulum ve daha fazlası hakkında ipuçları edinin.

! Önemli: Tipik Wi-Fi kapsama aralığı 45 ila 61 m. Kontrol ünitesini yönlendiriciye uygun bir mesafeye monte ettiğinizden emin olun.

🔗 support.hydrowise.com

Mount Your Controller

Plastic Cabinet

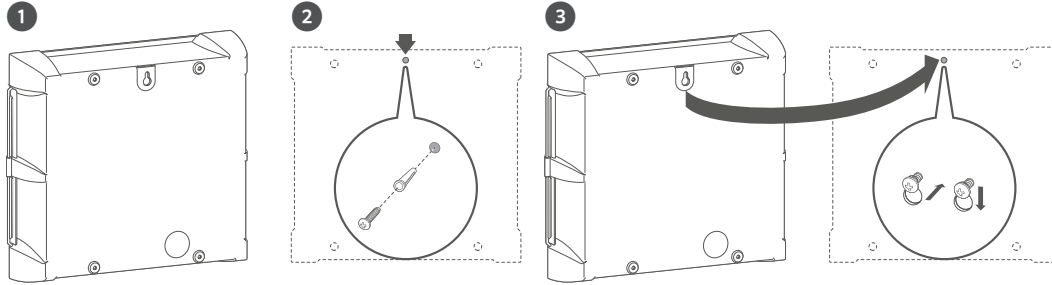

Metal Cabinet

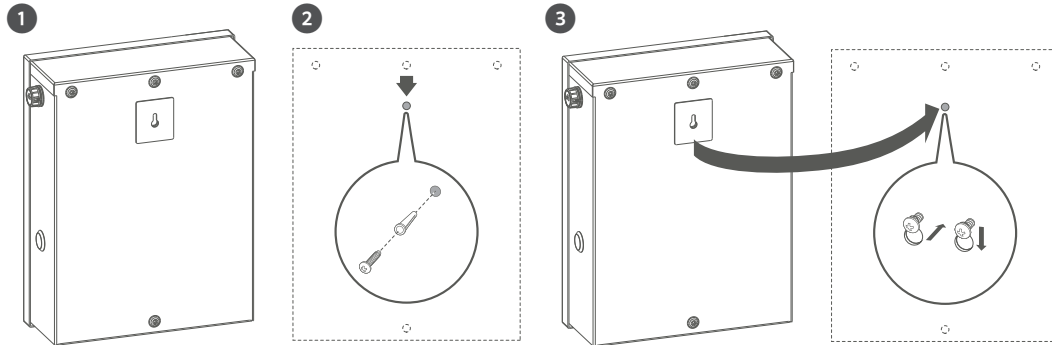

Plastic and Metal Controllers

1. Remove controller door and control panel for easier access.
2. Use enclosed hole template to mark and drill mounting holes. Leave enough room to open the door. Allow for screw anchors if necessary. Install top center screw first, and leave the screw head $\frac{1}{4}$ " (6 mm) out from the wall.
3. Hang the controller on the screw head.

DE Montage Ihres HCC-Steuergeräts mit Metall- oder Kunststoffgehäuse

1. Entfernen Sie für einen einfacheren Zugriff die Tür des Steuergeräts und das Bedienfeld.
2. Verwenden Sie die beiliegende Schablone, um die Markierungen für die Bohrungen zu übertragen. Sorgen Sie für ausreichend Platz, um die Gehäusetür öffnen zu können. Verwenden Sie Dübel falls notwendig. Befestigen Sie zunächst die mittlere Schraube oben und lassen dabei 6 mm Platz zwischen Schraubenkopf und Wand.
3. Hängen Sie das Steuergerät am Schraubenkopf auf.

ES Monte su programador HCC de caja de plástico o metal

1. Retire la puerta y el panel de control del programador para un acceso más sencillo.
2. Utilice la plantilla de agujeros incluida para marcar y taladrar los agujeros de montaje. Deje suficiente espacio para abrir la puerta. Utilice refuerzos de tornillos si es necesario. Instale el tornillo central superior primero, dejando un margen de 6 mm (¼") sobresaliendo de la pared.
3. Cuelgue el programador de la cabeza del tornillo.

FR Fixer votre programmeur HCC à boîtier en plastique ou en métal

1. Retirez la porte et le panneau de commande du programmeur pour faciliter l'accès.
2. Utilisez le gabarit inclus pour marquer et percer les orifices de fixation. Laissez suffisamment d'espace pour ouvrir la porte. Si nécessaire, utilisez des chevilles. Tout d'abord, installez la vis centrale du haut, en gardant un espace de 6 mm entre la tête de la vis et le mur.
3. Accrochez le programmeur à la tête de la vis.

IT Montaggio del programmatore HCC con armadietto in plastica o metallo

1. Rimuovere lo sportello del programmatore e il pannello di controllo per facilitare l'accesso.
2. Usare il modello di foratura incluso per contrassegnare e

trapanare i fori di montaggio. Prevedere spazio sufficiente per aprire lo sportello. Utilizzare tasselli, se necessario. Installare prima la vite centrale superiore e lasciare la testa della vite a una distanza di 6 mm dalla parete.

3. Appendere il programmatore sulla testa della vite.

PT Monte seu controlador HCC de gabinete plástico ou metálico

1. Remova a porta do controlador e o painel de controle para acesso mais fácil.
2. Use o modelo de perfuração incluso para marcar e perfurar os orifícios de montagem. Deixe espaço suficiente para abrir a porta. Use buchas se necessário. Instale o parafuso na parte superior central primeiro e deixe 6 mm da cabeça do parafuso para fora da parede.
3. Pendure o controlador na cabeça do parafuso.

RU Установите пластиковый или металлический шкаф контроллера HCC

1. Снимите дверцу контроллера и панель управления для упрощения доступа.
2. Используйте прилагаемый шаблон для разметки и высверливания монтажных отверстий. Оставьте достаточно места для открывания дверцы. При необходимости сделайте допуск на винтовые анкерные болты. Сначала установите верхний центральный болт и оставьте расстояние 6 мм от его головки до поверхности стены.
3. Повесьте контроллер на головку болта.

TR Plastik veya metal kabinli HCC kontrol ünitesini monte edin

1. Daha kolay erişim için kontrol ünitesinin kapağını ve kontrol panelini çıkartın.
2. Birlikte gönderilmiş şablonu deliklerin yerini işaretlemek ve delmek için kullanın. Kapağın açılabilmesi için alan bırakın. Gerekli olursa dübel kullanın. Öncelikle en üst merkez vidayı takın ve vidanın başlığını duvardan 6 mm dışarıda bırakın.
3. Vida başlığına kontrol ünitesini asın.

Install Your Controller

Plastic Cabinet

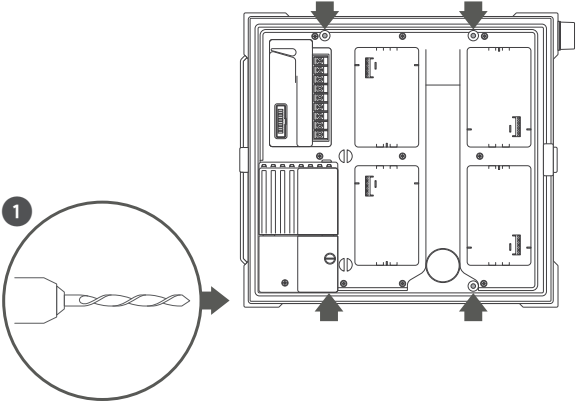

Metal Cabinet

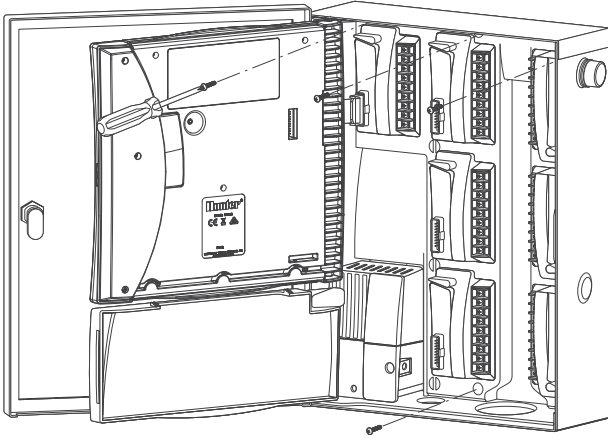
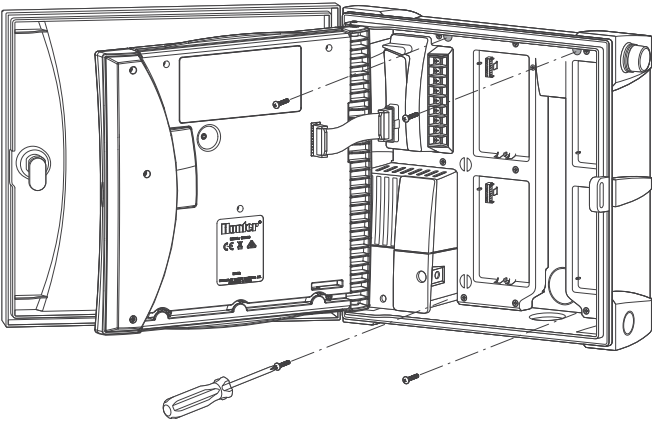
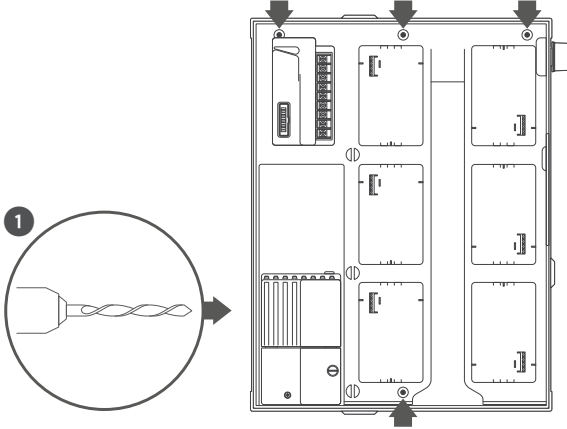

Plastic and Metal Controllers

1. Secure the controller in place by installing screws in the remaining holes from inside the cabinet. Replace control panel and door.

DE Installation des Steuergeräts

1. Befestigen Sie das Steuergerät mit den restlichen Schrauben über die verbleibenden Bohrlöcher im Gehäuse. Setzen Sie das Bedienfeld und die Tür wieder ein.

ES Instale su programador

1. Fije el programador colocando los tornillos en los orificios correspondientes restantes, desde el interior de la caja. Vuelva a colocar la puerta y el panel de control.

FR Installer votre programmeur

1. Fixez le programmeur en place en insérant des vis dans les orifices restants à partir de l'intérieur du boîtier. Remettez le panneau de commande et la porte.

IT Installazione del programmatore

1. Fissare il programmatore installando viti nei fori restanti dall'interno della centralina. Riposizionare il pannello di controllo e lo sportello.

PT Instale seu controlador

1. Prenda o controlador no lugar com os parafusos nos furos restantes de dentro do gabinete. Recoloque o painel de

controle e a porta.

RU Установите контроллер

1. Зафиксируйте контроллер, установив болты в остальные отверстия с внутренней стороны шкафа. Установите обратно панель управления и дверцу.

TR Kontrol Ünitenizin Kurulumu

1. Kabinin içinden diğer deliklere vida takarak kontrol ünitesinin sabitlenmesini sağlayın. Kontrol paneli ve kapağını tekrar yerleştirin.

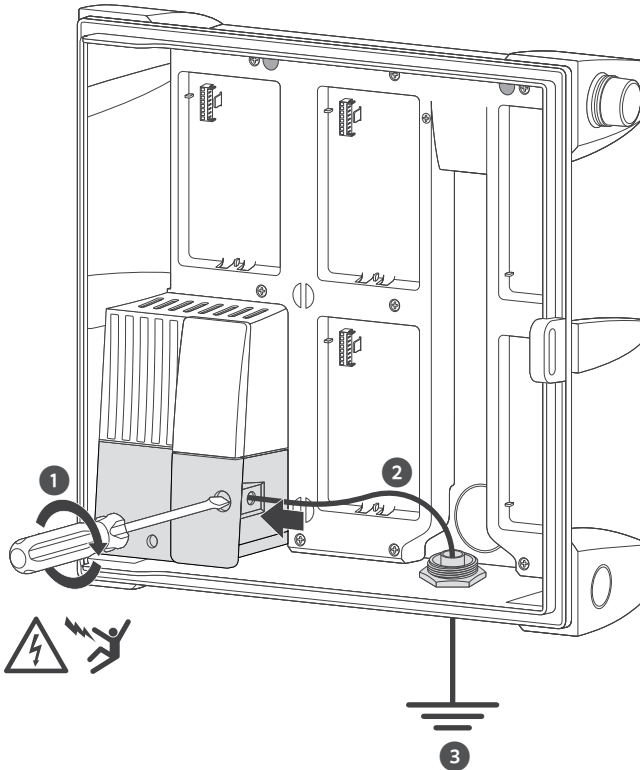

Earth Ground Connection (Lightning Protection)

1. Insert copper wire from earth ground hardware, and tighten screw in front.
2. Minimum 10 AWG (5 mm²) wire to earth ground hardware.
3. Add copper-clad steel ground rods and/or plates sufficient to achieve 10Ω or less resistance at a minimum 8' (2.5 m) away from controller.



Important:

Required for all metal and stainless steel configurations.

DE Anschluss des ergeräts mit dem Erdungssystem (Blitzschutz)

1. Führen Sie den Kupferdraht von der Hardware des Erdungssystems ein und ziehen Sie die Schraube an der Front an.
2. Mindestens 5 mm² Draht bis zur Hardware des Erdungssystems.
3. Fügen Sie einen kupferplattierten Erdungsstab und/oder -platten hinzu, die bei 2,5 m Entfernung zum Steuergerät einen 10Ω oder geringeren Erdungswiderstand erreichen.

! Wichtig: Erforderlich für alle Konfigurationen aus Metall und Edelstahl.

ES Conecte la conexión a tierra de su programador (protección contra relámpagos)

1. Introduzca el cable de cobre de la toma de tierra y apriete el tornillo frontal.
2. Utilice cable calibre 5 mm² (10 AWG) o superior para la toma de tierra.
3. Agregue suficientes placas o estacas de cobre chapado de acero para lograr una resistencia máxima de 10Ω a una distancia mínima de 2.5 m (8') respecto al programador.

! Importante: Requerido para todas las configuraciones de metal y acero inoxidable.

FR Raccorder votre programmeur à la terre (protection contre la foudre)

1. Insérez le câble en cuivre du matériel de mise à la terre, puis serrez la vis sur le devant.
2. Le câble connecté au matériel de mise à la terre doit avoir un calibre minimal de 5 mm².
3. Ajoutez des piquets et/ou des plaques de mise à la terre en acier plaqué cuivre pour atteindre une résistance de 10 Ω ou moins à une distance minimale de 2,5 m du programmeur.

! Important : Obligatoire pour toutes les installations en métal et en acier inoxydable.

IT Cablaggio del collegamento per la messa a terra del programmatore (protezione contro i fulmini)

1. Inserire il cavo dall'attrezzo di messa a terra, quindi serrare la vite nella parte anteriore.
2. Almeno 5 mm² all'attrezzo di messa a terra.
3. Aggiungere un numero sufficiente di picchetti e/o piastre di messa a terra in acciaio rivestito in rame per raggiungere una resistenza massima di 10Ω a una distanza minima di 2,5 m dal programmatore.

! Importante: Operazione necessaria per le configurazioni in metallo o acciaio inossidabile.

PT Conexão terra do controlador (proteção contra raios)

1. Insira o fio de cobre do hardware de aterramento e aperte o parafuso na frente.
2. Fio de no mínimo 5 mm² para o hardware de aterramento.
3. Adicione placas e/ou hastes de aço revestida de cobre suficientes para alcançar 10Ω ou menos de resistência a uma distância mínima de 2,5 m do controlador.

! Importante: Esse procedimento é necessário para todas as configurações com metal e aço inoxidável.

RU Подключение заземления контроллера (молниезащиты)

1. Вставьте медный провод из комплекта для заземления и затяните передний болт.
2. Используйте для заземления провод сечением не менее 5 мм².
3. Установите стальные заземляющие стержни с медным покрытием и/или пластины в количестве, достаточном для достижения сопротивления 10 Ω или менее, на расстоянии не менее 2,5 м от контроллера.

Важно! Обязательный элемент для всех вариантов конструкции из металла и нержавеющей стали.

TR Kontrol ünitenizin toprak hattını bağlama (yıldırım koruması)

1. Topraklama donanımından bakır teli koyun ve önündeki vidayı sıkın.
2. Topraklama donanımı için minimum 5 mm² kablo kullanın.
3. Kontrol ünitesinden minimum 2.5 m uzaklıkta, 10Ω veya daha az dirence erişebilmek için bakır kaplı topraklama çubuk ve/veya levhalarını ekleyin.

! Önemli: Tüm metal ve paslanmaz çelik yapılandırmaları için gereklidir.

120 V-Wire Block

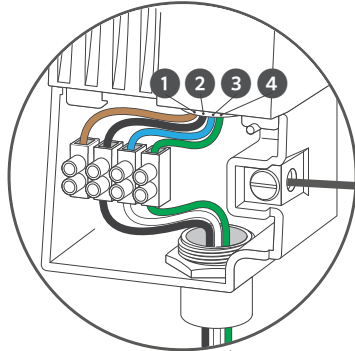

120 V-Wire Nut

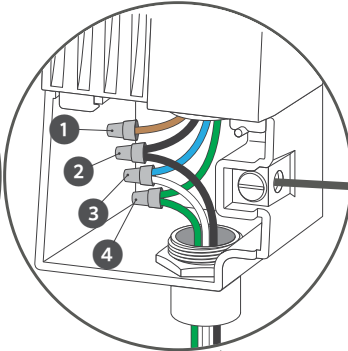

120 VAC Connections

	Transformer Wire		Power Source		
1	Brown	230 V (not used)	-	-	-
2	Black	120 V Hot	5	Black	120 V Hot
3	Blue	Neutral	6	White	Neutral
4	Green	Ground	7	Green	Ground

120 VAC Anschlüsse

DE	Transformorkabel		Stromquelle		
1	Braun	230 V (nicht verwendet)	-	-	-
2	Schwarz	120 V Heiß	5	Schwarz	120 V Heiß
3	Blau	Neutral	6	Weiß	Neutral
4	Grün	Erdung	7	Grün	Erdung

Onexiones 120 VCA

ES	Cable del transformador		Fuente de alimentación		
1	Marrón	230 V (no utilizado)	-	-	-
2	Negro	120 V Fase	5	Negro	120 V Fase
3	Azul	Neutral	6	Blanco	Neutral
4	Verde	Tierra	7	Verde	Tierra

Branchements 120 VCA

FR	Câble du transformateur		Source d'alimentation		
1	Marron	230 V (non utilisé)	-	-	-
2	Noir	Phase 120 V	5	Noir	Phase 120 V
3	Bleu	Neutre	6	Blanc	Neutre
4	Vert	Terre	7	Vert	Terre

Collegamenti 120 VAC

IT	Filo trasformatore		Fonte di alimentazione		
1	Marrone	230 V (non usato)	-	-	-
2	Nero	120 V Caldo	5	Nero	120 V Caldo
3	Blu	Neutro	6	Bianco	Neutro
4	Verde	Messa a Terra	7	Verde	Messa a Terra

Conexões 120 VCA

PT	Fio transformador		Fonte de alimentação		
1	Marrom	230 V (não usado)	-	-	-
2	Preto	120 V Quente	5	Preto	120 V Quente
3	Azul	Neutro	6	Branco	Neutro
4	Verde	Terra	7	Verde	Terra

Подключения 120 В Переменного Тока

RU	Провод трансформатора		Источник питания		
1	Коричневый	230 В (не используется)	-	--	--
2	Черный	Под напряжением 120 В	5	Черный	Под напряжением 120 В
3	Синий	Нейтраль	6	Белый	Нейтраль
4	Зеленый	Зеленый	7	Зеленый	Земля

120 VAC Bağlantıları

TR	Transformatör Kablosu		Güç Kaynağı		
1	Kahverengi	230 V (kullanılmıyor)	-	--	--
2	Siyah	120 V Sıcak	5	Siyah	120 V Sıcak
3	Mavi	Nötr	6	Mavi	Nötr
4	Yeşil	Toprak	7	Yeşil	Toprak

230 V-Wire Block

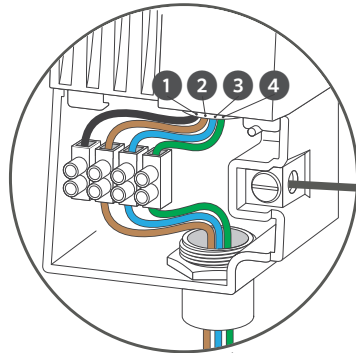

230 V-Wire Nut

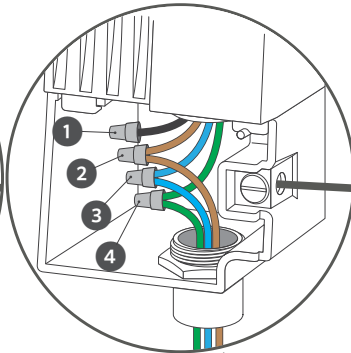

Onexiones 230 VCA

ES	Cable del transformador	Fuente de alimentación
1	Negro 120V (no utilizado)	- - -
2	Marrón 230V Fase	5 Negro 230V Fase
3	Azul Neutral	6 Azul o blanco Neutral
4	Verde Tierra	7 Verde Tierra

Branchements 230 VCA

FR	Câble du transformateur	Source d'alimentation
1	Noir 120V (non utilisé)	- - -
2	Marron Phase 230V	5 Marron Phase 230 V
3	Bleu Neutre	6 Bleu ou blanc Neutre
4	Vert Terre	7 Vert Terre

120 V Connections

Transformer Wire	Power Source
1 Black 120V (not used)	- - -
2 Brown 230V Hot	5 Brown 230V Hot
3 Blue Neutral	6 Blue or White Neutral
4 Green Ground	7 Green Ground

230 VAC Anschlüsse

DE	Transformatorkabel	Stromquelle
1 Schwarz 120V (nicht verwendet)	- - -	
2 Braun 230V Heiß	5 Braun 230V Heiß	
3 Blau Neutral	6 Blau oder Weiß Neutral	
4 Grün Erdung	7 Grün Erdung	

Collegamenti 230 VAC

IT	Filo trasformatore	Fonte di alimentazione
1 Nero 120 V (non usato)	- - -	
2 Marrone 230 V caldo	5 Marrone 230 V caldo	
3 Blu Neutro	6 Blu o Bianco Neutro	
4 Verde Messa a terra	7 Verde Messa a terra	

Conexões 230 VCA

PT	Fio transformador	Fonte de alimentação
1 Preto 120 V (não usado)	- - -	
2 Marrom 230 V quente	5 Marrom 230 V quente	
3 Azul Neutro	6 Branco Neutro	
4 Verde Terra	7 Verde Terra	

Подключения 230 В Переменного Тока

RU	Провод трансформатора		Источник питания		
1	Черный	120 В (не используется)	-	-	-
2	Коричневый	Под напряжением 230 В	5	Коричневый	Под напряжением 230 В
3	Синий	Нейтраль	6	Синий или белый	Нейтраль
4	Зеленый	Зеленый	7	Зеленый	Земля

230 VAC Bağlantıları

TR	Transformatör Kablosu		Güç Kaynağı		
1	Siyah	120V (kullanılmıyor)	-	-	-
2	Kahverengi	230V Sıcak	5	Kahverengi	230V Sıcak
3	Mavi	Nötr	6	Mavi veya Beyaz	Nötr
4	Yeşil	Toprak	7	Yeşil	Toprak

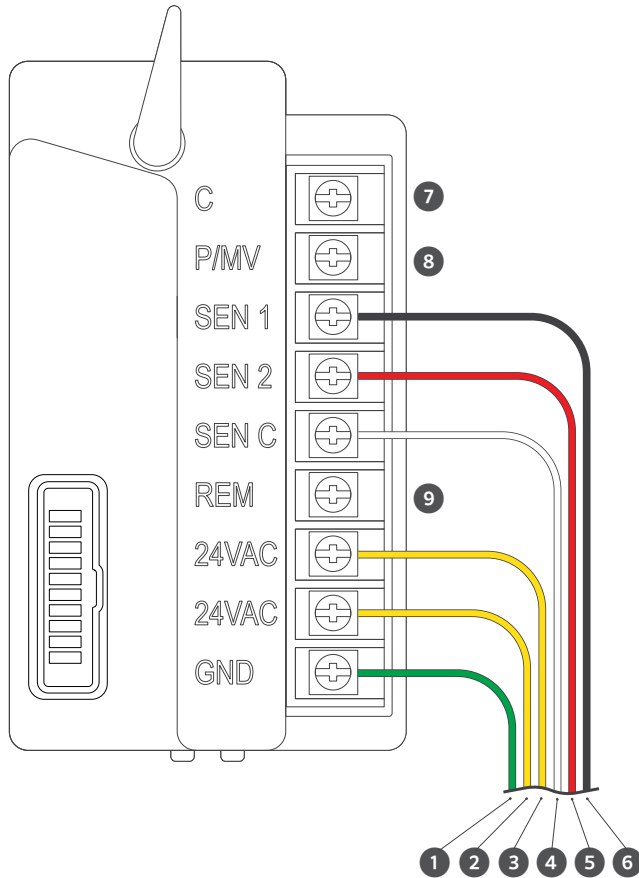

Power Module Terminals

1	Green	Ground	7	C	Common
2	Yellow	24 VAC Transformer	8	P/MV	Pump/Master Valve
3	Yellow	24 VAC Transformer	9	REM	Remote Control Input
4	White	Sensor Common	10	White	Sensor Common
5	Red	Rain Sensor	11	Red	Rain Sensor
6	Black	Flow Meter	12	Black	Flow Meter

DE Anschlüsse des Leistungsmoduls

1	Grün	Erdung	7	C	Gemeinsam
2	Gelb	24 VAC Transformator	8	P/MV	Pumpen-/Hauptventil
3	Gelb	24 VAC Transformator	9	REM	Eingang der Fernsteuerung
4	Weiß	Sensoranschluss	10	Weiß	Sensoranschluss
5	Rot	Regensensor	11	Rot	Regensensor
6	Schwarz	Durchflussmessgerät	12	Schwarz	Durchflussmessgerät

ES Terminales del módulo de alimentación

1	Verde	Terra	7	C	Común
2	Amarillo	Transformador de 24 VCA	8	P/MV	Bomba/Válvula Maestra
3	Amarillo	Transformador de 24 VCA	9	REM	Remote Control Input
4	Blanco	Común del Sensor	10	Blanco	Común del Sensor
5	Rojo	Medidor de Caudal	11	Rojo	Sensor de Lluvia I
6	Negro	Sensor de Lluvia	12	Negro	Medidor de Cauda

FR Bornes du module d'alimentation

1	Vert	Terre	7	C	Neutre
2	Jaune	Transformateur 24 V c.a.	8	P/MV	Pompe/Électrovanne Principale
3	Jaune	Transformateur 24 V c.a.	9	REM	Entrée de la Télécommande
4	Blanc	Fil Neutre de la Sonde	10	Blanc	Fil Neutre de la Sonde
5	Rouge	Sonde de Pluie	11	Rouge	Sonde de Pluie
6	Noir	Débitmètre	12	Noir	Débitmètre

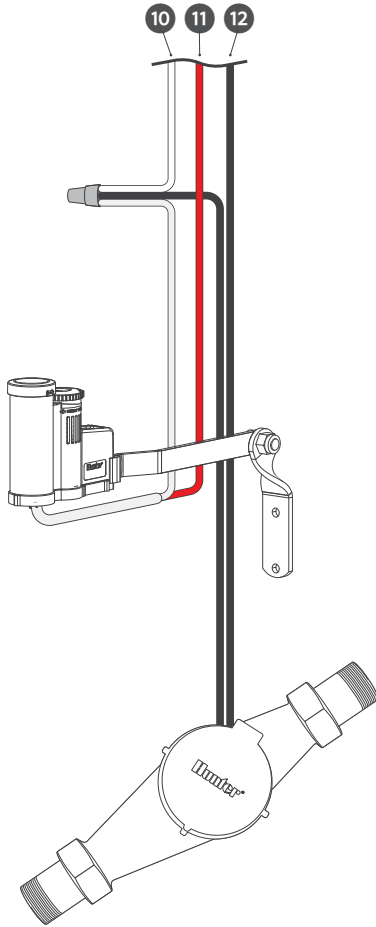

IT Terminali modulo di alimentazione

1	Verde	Messa a Terra	7	C	Comune
2	Giallo	Trasformatore 24 VAC	8	P/MV	Valvola Principale/Pompa
3	Giallo	Trasformatore 24 VAC	9	REM	Ingresso Seleccionando
4	Bianco	Comune del Sensore	10	Bianco	Comune del Sensore
5	Rosso	Sensore Pioggia	11	Rosso	Sensore Pioggia
6	Nero	Misuratore di Portata	12	Nero	Misuratore di Portata

PT Terminais do módulo de alimentação

1	Verde	Terra	7	C	Comum
2	Amarelo	Transformador de 24 VCA	8	P/MV	Bomba/Válvula Principal
3	Amarelo	Transformador de 24 VCA	9	REM	Entrada de Controle Remoto
4	Branco	Comum de Sensor	10	Branco	Comum de Sensor
5	Vermelho	Sensor de Chuva	11	Vermelho	Sensor de Chuva
6	Preto	Medidor de Vazão	12	Preto	Medidor de Vazão

RU Клеммы модуля питания

1	Зеленый	Земля	7	C	Общий провод
2	Желтый	Трансформатор 24 В	8	P/MV	Насос/главный клапан
3	Желтый	Трансформатор 24 В	9	REM	Вход дистанционного управления
4	белый	Общий датчик	10	белый	Общий датчик
5	Красный	Датчик дождя	11	Красный	Датчик дождя
6	Черный	Расходомер	12	Черный	Расходомер

TR Güç Modülü Terminalleri

1	Yeşil	Toprak	7	C	Ortak
2	Sarı	24 VAC Transformatör	8	P/MV	Pompa/Ana Vana
3	Sarı	24 VAC Transformatör	9	REM	Uzaktan Kumanda Girişi
4	Beyaz	Sensör Ortak	10	Beyaz	Sensör Ortak
5	Kırmızı	Yağmur Sensörü	11	Kırmızı	Yağmur Sensörü
6	Siyah	Debi Ölçer	12	Siyah	Debi Ölçer

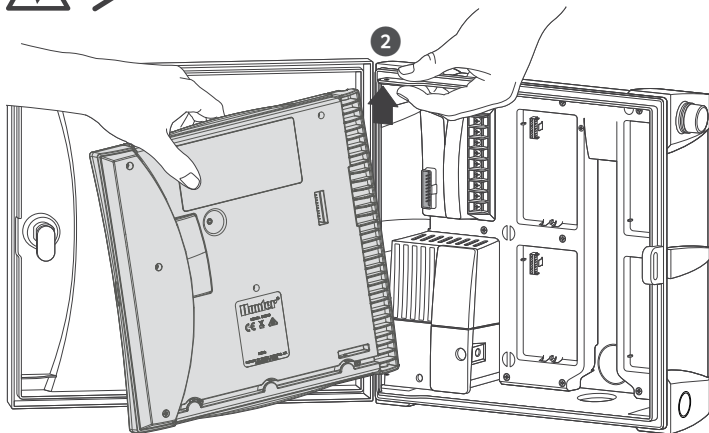
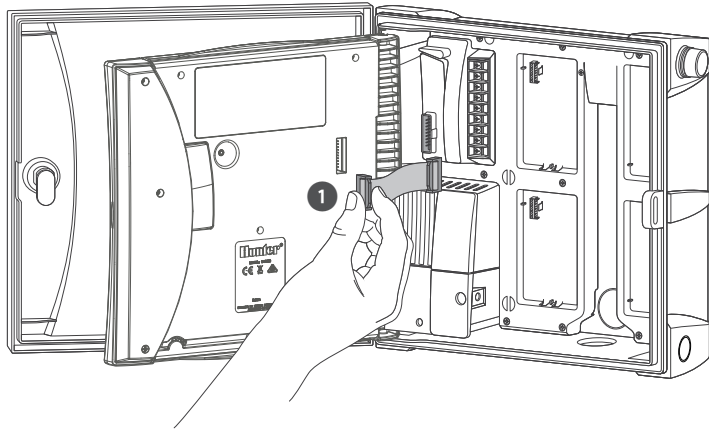

ICC or ICC2 Controllers



Important:

Turn AC power off at the source, and verify that it is off.

1. Disconnect the facepack ribbon cable.
2. Remove and replace the ICC or ICC2 facepack with the HCC Hydrawise-ready facepack.

DE Nachrüsten Ihrer ICC und ICC2 Steuergeräte zu einem Hydrawise Ready Steuergerät

! Wichtig: Schalten Sie die Netzspannung an der Spannungsquelle aus.

1. Trennen Sie das Flachbandkabel der Bedienfront und entfernen Sie die Bedienfront.
2. Tauschen Sie die Bedienfront des ICC oder ICC2 Steuergeräts mit der HCC Hydrawise Ready Bedienfront aus.

ES Actualice sus programadores ICC e ICC2 a un programador compatible con Hydrawise

! Importante: Desconecte la corriente en la fuente de alimentación.

1. Desconecte el cable plano y retire la carátula.
2. Retire la carátula del ICC o ICC2 y reemplácela con la carátula HCC compatible con Hydrawise.

FR Transformer votre programmeur ICC ou ICC2 en programmeur compatible Hydrawise

! Important : Coupez l'alimentation électrique au niveau de la source.

1. Débranchez le câble plat de la façade, puis retirez la façade.
2. Retirez la façade ICC ou ICC2 et remplacez-la par la façade HCC compatible Hydrawise.

IT Aggiornate i programmatori ICC e ICC2 ad un modello predisposto per Hydrawise

! Importante: Scollegare l'alimentazione elettrica.

1. Scollegare il cavo piatto del frontalino, quindi rimuovere il frontalino.
2. Rimuovete e sostituite il frontalino di ICC o ICC2 con il frontalino HCC predisposto per Hydrawise.

PT Atualize seus controladores ICC ou ICC2 para se tornarem compatíveis com o Hydrawise

! Importante: Desligue a alimentação CA na fonte e verifique se ela está desligada.

1. Desconecte a cinta de fios do pacote.
2. Remova o painel frontal do ICC ou ICC2 e substitua-o pelo painel frontal do HCC, compatível com o Hydrawise.

RU Модернизация вашего контроллера ICC или ICC2 до уровня контроллера с поддержкой Hydrawise

Важно! Отключите источник питания переменного тока и убедитесь, что питание отсутствует.

1. Отсоедините ленточный кабель передней панели.
2. Снимите панель управления ICC или ICC2 и замените ее на панель управления контроллера HCC с поддержкой Hydrawise.

TR ICC ve ICC2 kontrol ünitelerinizi Hydrawise yazılımlı kontrol ünitesi ile yenileyin

! Önemli: AC elektrik kaynağını kapatın ve kapatıldığından emin olun.

1. Arayüz şerit (ribon) kablosunun bağlantısını kesin.
2. ICC veya ICC2 arayüzünü çıkarıp HCC Hydrawise yazılımlı arayüz ile değiştirin.

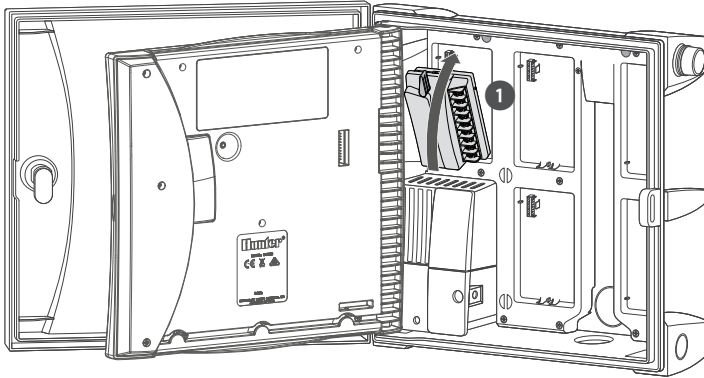

ICC and ICC2 Controllers

1. Remove all wiring from the ICC or ICC2 power module.
2. Remove and replace power module by rotating the locking lever up, then insert the new power module and rotate the locking lever down.
3. Reinstall power module wires.
4. Reconnect ribbon cable to facepack and power module.

DE Nachrüsten Ihrer ICC und ICC2 Steuergeräte

1. Entfernen Sie die Verkabelung des ICC oder ICC2 Leistungsmoduls.
2. Entfernen Sie das Leistungsmodul, indem Sie den Sperrhebel nach oben drehen, setzen Sie das neue Leistungsmodul ein und drehen Sie den Sperrhebel nach unten.
3. Installieren Sie die Kabel des Netzteils wieder.
4. Verbinden Sie die Bedienfront über das Flachbandkabel mit dem Leistungsmodul.

ES Actualice su programador ICC o ICC2

1. Retire todo el cableado del módulo de alimentación ICC o ICC2.
2. Retire y reemplace el módulo de alimentación girando la palanca de bloqueo hacia arriba, y luego inserte el nuevo módulo de alimentación y gire la palanca de bloqueo hacia abajo.
3. Vuelva a instalar los cables del módulo de alimentación.
4. Reconecte el cable plano a la carátula y al módulo de alimentación.

FR Moderniser votre programmeur ICC ou ICC2

1. Débranchez tous les câbles du module d'alimentation ICC ou ICC2.
2. Retirez et remplacez le module d'alimentation en faisant pivoter le levier de verrouillage vers le haut, puis insérez le nouveau module d'alimentation et faites pivoter le levier de verrouillage vers le bas.
3. Réinstallez les câbles du module d'alimentation.
4. Rebranchez le câble ruban à la façade et au module d'alimentation.

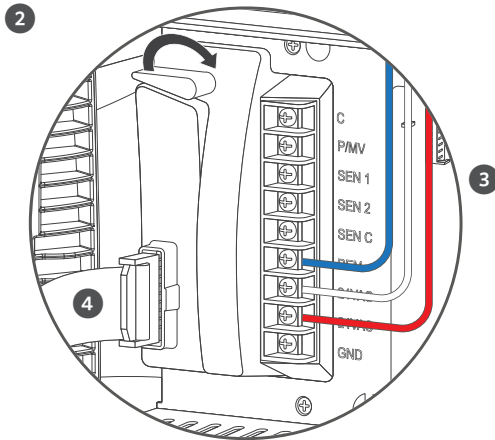

IT Aggiornate il programmatore ICC o ICC2

1. Rimuovete tutti i cavi dal modulo di alimentazione di ICC o ICC2.
2. Rimuovete e sostituite il modulo di alimentazione ruotando la leva di blocco verso l'alto, quindi inserite il nuovo modulo di alimentazione e ruotate la leva di blocco verso il basso.
3. Reinstallare i cavi del modulo di alimentazione.
4. Ricollegate il cavo piatto al frontalino e al modulo di alimentazione.

PT Atualize seu controlador ICC ou ICC2

1. Remova toda a fiação do módulo de alimentação do ICC ou ICC2.
2. Remova o módulo de alimentação girando a alavanca de travamento para cima. Em seguida, insira o novo módulo de alimentação e gire a alavanca de travamento para baixo.
3. Reinstale a fiação do módulo de energia.
4. Reconecte o cabo plano ao painel frontal e ao módulo de alimentação.

RU Модернизация вашего контроллера ICC или ICC2

1. Отсоедините всю проводку от модуля питания ICC или ICC2.
2. Снимите и замените модуль питания: для этого поверните блокирующий рычаг вверх, затем установите новый модуль питания и поверните блокирующий рычаг вниз.
3. Заново подсоедините провода к модулю питания.
4. Подключите ленточный кабель к панели управления и модулю питания.

TR ICC veya ICC2 kontrol ünitenizi yenileyin

1. ICC veya ICC2 güç modülündeki tüm kabloları çıkarın.
2. Kilitleme kolunu yukarı kaydırarak güç modülünü çıkarıp değiştirin. Yeni güç modülünü takın ve kilitleme kolunu aşağı doğru kaydırın.
3. Güç modülü kablolarını yeniden takın.
4. Şerit kabloyu arayüze ve güç modülüne tekrar bağlayın.

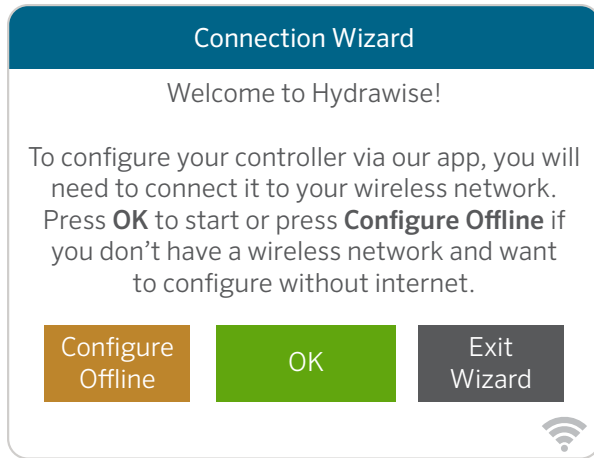

Configure Your Controller Offline

From the Connection Wizard screen, touch **Configure Offline**. Tap **OK** to move on to the next step.

Enter in today's date if it hasn't already been set or if it is incorrect. Enter today's time if it hasn't already been set or if it is incorrect. From this screen, touch **OK**.

Next enable a **Master Valve**, if you don't have a master valve then choose **Disable Master Valve**. Then touch **OK**.

You can now enter the run length you want for your default zone run time. Then touch **OK**.

Next, set how often each zone will run. As advised on the previous screen, you can set individual frequencies for each zone. Touch **OK** to proceed.

From **Zones** screen, you can manually configure each zone according to your desired schedule. Touch the **Add** button to add a program start time and follow the steps below. You can toggle between zones by touching **Next** or **Previous** buttons or you can leave the start time to **Apply to All Zones**.

DE Steuergerät offline konfigurieren

Klicken Sie im Bildschirm des Verbindungsassistenten auf **Configure Offline** (Offline konfigurieren). Klicken Sie auf **OK**, um mit dem nächsten Schritt fortzufahren.

Geben Sie das aktuelle Datum an, falls dies noch nicht erfolgt oder falsch ist. Geben Sie die aktuelle Uhrzeit an, falls dies noch nicht erfolgt oder diese falsch ist. Klicken Sie in diesem Bildschirm auf **OK**. Aktivieren Sie als nächstes ein **Master Valve** (Hauptventil). Wenn Sie über kein Hauptventil verfügen, wählen Sie **Disable Master Valve** (Hauptventil deaktivieren). Drücken Sie **OK**.

Geben Sie die gewünschte Lauflänge Ihrer Standard-Zonenlaufzeit ein. Drücken Sie **OK**.

Wählen Sie als nächstes, wie lange jede Zone ausgeführt werden soll. Wie Sie bereits auf dem vorherigen Bildschirm gelesen haben, können Sie individuelle Frequenzen für jede Zone einstellen. Klicken Sie auf **OK**, um fortzufahren.

Auf diesem Bildschirm können Sie nun manuell jede **Zones** (Zone) nach Ihrem gewünschten Zeitplan konfigurieren. Klicken Sie auf die Taste **Add** (Hinzufügen), um eine Programmstartzeit hinzuzufügen und befolgen Sie die nachfolgenden Schritte. Über die Tasten **Next** (Nächste) oder **Previous** (Vorherige) können Sie zwischen den Zonen umschalten oder die Startzeit mit **Apply to All Zones** (Auf alle Zonen anwenden) festlegen.

ES Configure su programador sin conexión a Internet

En la pantalla del asistente de conexión, pulse **Configure Offline** (Configuración en modo desconectado). Pulse **OK** para pasar al siguiente paso.

Introduzca la fecha de hoy si es que no ha sido configurada o si es incorrecta. Introduzca la hora actual si es que no ha sido configurada o si es incorrecta. Desde esta pantalla, pulse **OK**.

A continuación, habilite una **Master Valve** (Válvula maestra); si no tiene una válvula maestra, seleccione **Disable Master Valve** (Deshabilitar válvula maestra). Luego pulse **OK**.

Ahora puede introducir el tiempo que desee para el riego de la zona predeterminada. Luego pulse **OK**.

A continuación, configure la frecuencia con que cada zona regará. Como se indicó en la pantalla anterior, puede configurar frecuencias individuales para cada zona. Pulse **OK** para continuar.

En la pantalla **Zones** (Zonas), puede configurar manualmente cada zona de acuerdo a su horario deseado. Pulse el botón **Add** (Agregar) para agregar una hora de arranque del programa y siga los pasos a continuación. Puede alternar las zonas pulsando los botones **Next** (Siguiente) o **Previous** (Anterior), o puede dejar la hora de arranque en **Apply to All Zones** (Aplicar a todas las zonas).

FR Configurer votre programmeur hors connexion

Sur l'écran de l'assistant de connexion, appuyez sur **Configure Offline** (configurer hors connexion). Appuyez sur **OK** pour passer à l'étape suivante.

Saisissez la date du jour si elle n'a pas encore été paramétrée ou si elle est incorrecte. Saisissez l'heure actuelle si elle n'a pas encore été paramétrée ou si elle est incorrecte. Sur cet écran, appuyez sur **OK**.

Ensuite, activez une **Master Valve** (électrovanne principale). Si vous n'avez pas d'électrovanne principale, choisissez **Disable Master Valve** (désactiver l'électrovanne principale). Appuyez ensuite sur **OK**.

Vous pouvez maintenant saisir la durée d'arrosage par défaut que vous voulez pour vos zones. Appuyez ensuite sur **OK**.

Maintenant, paramétrez la fréquence d'arrosage de chaque zone. Comme conseillé à l'écran précédent, vous pouvez paramétrer des fréquences individuelles pour chaque zone. Appuyez sur **OK** pour continuer.

Sur l'écran **Zones**, vous pouvez configurer manuellement chaque zone en fonction du calendrier que vous souhaitez. Appuyez sur le bouton **Add** (ajouter) pour ajouter une heure de début du programme, puis suivez les étapes ci-dessous. Vous pouvez passer

d'une zone à l'autre en appuyant sur le bouton **Next** (suivant) ou **Previous** (précédent), ou vous pouvez laisser l'heure de début pour qu'elle s'applique à toutes les zones **Apply to All Zones**.

IT Configurazione del programmatore offline

Dalla schermata della connessione guidata, toccate **Configure Offline (Configura offline)**. Toccate **OK** per passare alla fase successiva.

Inserite la data odierna se non risulta già impostata o se non è corretta. Inserite l'ora attuale se non risulta già impostata o se non è corretta. In questa schermata, toccate **OK**.

A questo punto, abilitate una **Master Valve (Valvola principale)**; se non ne è disponibile una, scegliete **Disable Master Valve (Disabilita valvola principale)**, quindi toccate **OK**.

Inserite la durata desiderata per il tempo di irrigazione predefinito della zona, quindi toccate **OK**.

Impostate la frequenza di irrigazione di ciascuna zona. Come indicato nella schermata precedente, potete impostare singole frequenze per ogni zona. Toccate **OK** per continuare.

Dalla schermata **Zones (Zone)**, potete configurare manualmente ciascuna zona in base alla programmazione desiderata. Toccate il pulsante **Add (Aggiungi)** per aggiungere un orario di avvio dei programmi e procedete come segue. Potete passare da una zona all'altra toccando i pulsanti **Next (Avanti)** o **Previous (Indietro)** oppure potete impostare l'orario di avvio su **Apply to All Zones (Applica a tutte le zone)**.

PT Configure seu controlador off-line (sem acesso a internet)

Na tela do Connection Wizard (assistente de conexão), toque em **Configure Offline (Configurar off-line)**. Toque em **OK** para ir para a próxima etapa.

Insira a data de hoje caso ainda não tenha sido definida ou esteja incorreta. Insira o horário de hoje caso ainda não tenha sido definido ou esteja incorreto. Nessa tela, toque em **OK**.

Em seguida, ative uma **Master Valve** (válvula mestre). Caso não haja uma válvula mestre, selecione a opção **Disable Master Valve** (desativar válvula mestre). Toque em **OK**.

Agora você pode inserir a duração desejada para o tempo de rega padrão dos setores. Toque em **OK**.

Em seguida, defina a frequência de rega de cada setor. Conforme informado na tela anterior, você pode definir frequências específicas para cada setor. Toque em **OK** para continuar.

Na tela **Zones** (setores), é possível configurar cada setor manualmente de acordo com a programação desejada. Toque no botão **Add** (adicionar) para incluir um horário de início do programa e siga os passos abaixo. Você pode alternar entre os setores usando os botões **Next** (próximo) ou **Previous** (anterior), ou pode deixar o horário de início na opção **Apply to All Zones** (aplicar a todos os setores).

RU Настройте ваш контроллер в автономном режиме

На экране мастера подключения нажмите **Configure Offline** (Настроить в автономном режиме). Для перехода к следующему этапу нажмите **OK**.

Введите текущую дату, если она еще не была введена или отличается от реальной. Введите текущее время, если время еще не было введено или отличается от реального. На этом экране нажмите **OK**.

Далее активируйте **Enable Master Valve** (Главный клапан), если главного клапана у вас нет, выберите **Disable Master Valve** (Отключить главный клапан). Затем нажмите **OK**.

Теперь вы можете ввести желаемое время работы, которое будет использоваться для полива зон по умолчанию. Затем нажмите **OK**.

Далее установите периодичность полива каждой зоны. Как

было указано на предыдущем экране, вы можете установить периодичность полива для каждой зоны индивидуально. Для продолжения нажмите **OK**.

На экране **Zones** (Зоны) вы можете вручную настроить каждую зону в соответствии с желаемым графиком. Нажмите кнопку **Add** (Добавить), чтобы добавить время запуска программы, и выполните следующие действия. Для переключения между зонами можно использовать кнопки **Next** (Далее) или **Previous** (Назад) или же оставить значение времени запуска равным **Apply to All Zones** (Применить ко всем зонам).

TR Kontrol Ünitenizi Çevrimdışı Yapılandırma

Bağlantı Sihirbazı ekranında **Configure Offline** (Çevrimdışı Yapılandır) seçeneğine dokununuz. Bir sonraki adıma geçmek için **OK** (Tamam)'a dokununuz.

Ayarlı değilse veya girilen tarih yanlışsa güncel tarihi giriniz. Ayarlı değilse veya girilen saat yanlışsa saati giriniz. Bu ekranda **OK** (Tamam)'a dokununuz.

Ardından **Enable Master Valve** (Ana Vanayı Etkinleştir), ana vananız yoksa **Disable Master Valve** (Ana Vanayı Devre Dışı Bırak) seçeneğini seçiniz. Daha sonra **OK** (Tamam)'a dokununuz.

Artık varsayılan bölgenizin çalışma süresi için çalışma uzunluğunu girebilirsiniz. Daha sonra **OK** (Tamam)'a dokununuz.

Ardından her bir bölgenin ne sıklıkta çalışacağını ayarlayınız. Önceki ekranda tavsiye edildiği üzere her bir bölge için ayrı çalışma sıklığı ayarlayabilirsiniz. Devam etmek için **OK** (Tamam)'a dokununuz.

Zones (Bölgeler) ekranında, her bir bölgeyi istediğiniz programa göre manüel olarak yapılandırabilirsiniz. Program başlangıç zamanı eklemek için **Add** (Ekle) düğmesine dokununuz ve aşağıdaki adımları takip edin. **Next** (Sonraki) veya **Previous** (Önceki) düğmelerine dokunarak bölgeler arasında geçiş yapabilir veya başlangıç zamanını **Apply to All Zones** (Tüm Bölgelere Uygula) olarak bırakabilirsiniz.

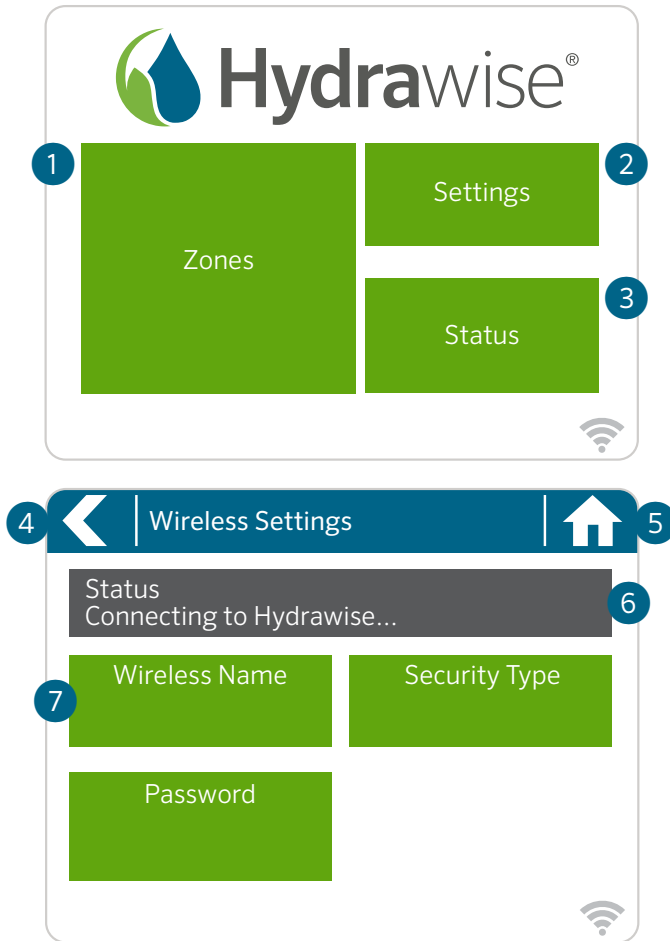

Home Screen Navigation

- ① Touch to view all zones.
- ② Touch to change controller settings.
- ③ Touch to view controller status information.
- ④ Go to previous screen (changes not saved).
- ⑤ Go to Home screen (changes not saved).
- ⑥ GRAY items indicate status information.
- ⑦ GREEN items indicate settings which can be changed.

DE Grundlagen zu „Ihr Touchscreen-Steuergerät“ und „Startbildschirm Navigation“

- ① Berühren, um alle Zonen anzuzeigen.
- ② Berühren, um die Steuergerät-Einstellungen zu ändern.
- ③ Berühren, um die Statusinformationen des Steuergeräts aufzurufen.
- ④ Zum vorherigen Bildschirm wechseln (Änderungen werden nicht gespeichert).
- ⑤ Zum Startbildschirm wechseln (Änderungen werden nicht gespeichert).
- ⑥ GRAUE Elemente zeigen Statusinformationen an.
- ⑦ GRÜNE Elemente zeigen Einstellungen an, die geändert werden können.

ES Información básica de su programador con pantalla táctil y navegación de la pantalla de inicio

- ① Pulse para ver todas las zonas.
- ② Pulse para cambiar los ajustes del programador.
- ③ Pulse para ver la información del estado del programador.
- ④ Ir a la pantalla previa (no guardarán los cambios).
- ⑤ Ir a la pantalla de inicio (no se guardarán los cambios).
- ⑥ Los elementos color GRIS indican la información del estado.
- ⑦ Los elementos color VERDE indican los ajustes que pueden cambiarse.

FR Principes de navigation de base pour votre programmeur à écran tactile et l'écran d'accueil

- ① Appuyez pour afficher toutes les zones.
- ② Appuyez pour modifier les paramètres du programmeur.
- ③ Appuyez pour consulter des informations sur l'état du programmeur.
- ④ Aller à l'écran précédent (les modifications ne sont pas enregistrées).
- ⑤ Aller à l'écran d'accueil (les modifications ne sont pas enregistrées).
- ⑥ Les éléments en GRIS indiquent des informations sur l'état.
- ⑦ Les éléments en VERT indiquent des paramètres pouvant être modifiés.

IT Informazioni di base sul touchscreen e la navigazione nella schermata principale

- ① Toccate per visualizzare tutte le zone.
- ② Toccate per modificare le impostazioni del programmatore.
- ③ Toccate per visualizzare le informazioni sullo stato del programmatore.
- ④ Consente di tornare alla schermata precedente (senza salvare le modifiche).
- ⑤ Consente di tornare alla schermata principale (senza salvare le modifiche).
- ⑥ Le voci in GRIGIO indicano informazioni sullo stato.
- ⑦ Le voci in VERDE indicano impostazioni che è possibile modificare.

PT Noções básicas da tela sensível ao toque e da navegação pela tela inicial

- ① Toque para ver todos os setores.
- ② Toque para alterar as configurações do controlador.
- ③ Toque para ver as informações do status do controlador.
- ④ Ir para a tela anterior (as alterações não são salvas).
- ⑤ Ir para a tela inicial (as alterações não são salvas).

- ⑥ Os itens em CINZA indicam as informações do status.
- ⑦ Os itens em VERDE indicam as configurações que podem ser alteradas.

RU Общая информация о навигации в меню вашего контроллера с сенсорным экраном и на главном экране

- ① Нажмите для просмотра всех зон.
- ② Нажмите для изменения настроек контроллера.
- ③ Нажмите для просмотра информации о статусе контроллера.
- ④ Переход к предыдущему экрану (без сохранения изменений).
- ⑤ Переход к главному экрану (без сохранения изменений).
- ⑥ СЕРЫМ цветом выделена информация о статусе.
- ⑦ ЗЕЛЕНЫМ цветом выделены настройки, которые могут быть изменены.

TR Dokunmatik Ekranlı Kontrol Üniteniz ve Ana Ekranda Gezinti Hakkında Temel Bilgiler

- ① Tüm bölgeleri görüntülemek için View all zones (Tüm bölgeleri görüntüle) a dokunun.
- ② Kontrol ünitesi ayarlarını değiştirmek için Change controller settings (Kontrol ünitesi ayarlarını değiştir)'e dokunun.
- ③ Kontrol ünitesi durum bilgilerini görüntülemek için View controller status information'e dokunun.
- ④ Önceki ekrana (Previous screen) gidin (değişiklikler kaydedilmez).
- ⑤ Ana Ekran (Home Screen) gidin (değişiklikler kaydedilmez).
- ⑥ GRİ öğeler durum bilgilerini belirtir.
- ⑦ YEŞİL öğeler, değiştirilebilecek ayarları belirtir.

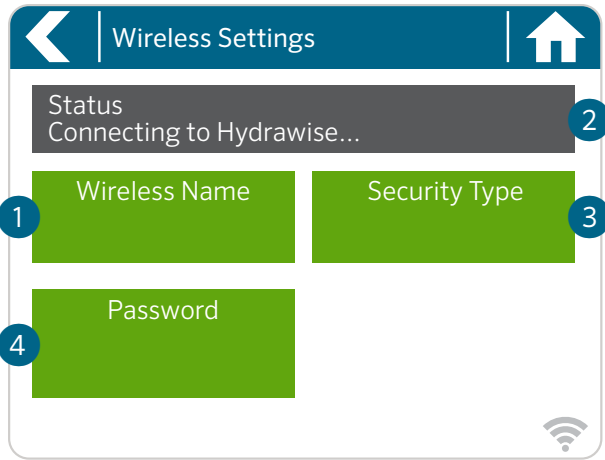



Using the Connection Wizard



From Home screen touch **Settings** button then the **Wireless** button. Select your wireless network from the list shown on the controller display and press the **Confirm** button on screen. Enter your wireless password and press the **OK** button on keyboard.



Important:



If your network is not listed then check that the unit is within wireless range. Make sure you press the **OK** button after you've entered your password. Pressing the **Home**  or **Back**  buttons will not save your changes.

- ① Touch to change wireless access point.
- ② Current wireless connection status.
- ③ Touch to change wireless security type.
- ④ Touch to change wireless password.



When connecting to your wireless, the **Wi-Fi**  icon at the bottom right of the controller screen will flash. Connecting takes about 30 seconds and when successfully connected the **Wi-Fi**  icon will remain solid.

DE Verbindung Ihres Steuergeräts mit dem Internet über den Verbindungsassistenten

Wählen Sie Ihr Drahtlosnetzwerk aus der Liste im Display des Steuergeräts und drücken Sie auf die Taste **Confirm** (Bestätigen). Geben Sie Ihr Kennwort ein und drücken Sie auf die Taste **OK** auf dem Tastenfeld.



! Wichtig: Sollte Ihr Netzwerk nicht in der Liste aufgeführt sein, dann überprüfen Sie, ob sich das Gerät innerhalb der Netz-Reichweite befindet. Denken Sie daran, die Taste **OK** zu drücken, nachdem Sie Ihr Kennwort eingegeben haben. Durch das Drücken der Tasten **Home**  (**Start**) oder **Back**  (**Zurück**) werden Ihre Änderungen nicht gespeichert.

- ① Berühren, um drahtlosen Zugangspunkt zu ändern.
- ② Aktueller Drahtlosverbindungsstatus.
- ③ Berühren, um drahtlosen Sicherheitstyp zu ändern.
- ④ Berühren, um Wi-Fi-Kennwort zu ändern.



Wenn Sie sich mit Ihrem Drahtlosnetzwerk verbinden, blinkt das Wi-Fi-Symbol  unten rechts auf dem Display des Steuergeräts auf. Der Verbindungsaufbau dauert ca. 30 Sekunden. Ist die Verbindung erfolgreich hergestellt, hört das Wi-Fi-Symbol  auf zu blinken und leuchtet konstant.

ES Conecte su programador a Internet usando el asistente de conexión

Seleccione su red inalámbrica de la lista mostrada en la pantalla del programador y pulse el botón **Confirm** (Confirmar) en la pantalla. Introduzca la contraseña de su red inalámbrica y pulse el botón **OK** en el teclado.



! Importante: Si su red no aparece en la lista, compruebe que la unidad se encuentra dentro del alcance de la señal inalámbrica. Asegúrese de pulsar el botón **OK** tras ingresar la contraseña. Si pulsa los botones **Home**  (Inicio) o **Back**  (Atrás), no se guardarán los cambios.

- ① Toque para cambiar el punto de acceso inalámbrico.
- ② Estado actual de la conexión inalámbrica.
- ③ Toque para cambiar el tipo de seguridad inalámbrica.
- ④ Toque para cambiar la contraseña de la red inalámbrica.



Al conectarse a su red inalámbrica, el ícono **Wi-Fi**  en la parte inferior derecha del programador parpadeará. La conexión tarda aproximadamente 30 segundos, y cuando se conecte, el ícono **Wi-Fi**  permanecerá fijo.

FR Connecter votre programmeur à Internet à l'aide de l'assistant de connexion

Sélectionnez votre réseau sans fil dans la liste qui s'affiche sur l'écran du programmeur et appuyez sur le bouton **Confirm** (confirmer) de l'écran. Saisissez votre mot de passe sans fil et appuyez sur le bouton **OK** du clavier.



! Important : Si votre réseau n'est pas répertorié, assurez-vous que l'unité est à portée du réseau sans fil. Assurez-vous d'appuyer sur le bouton **OK** une fois que vous avez saisi votre mot de passe. Si vous appuyez sur le bouton **Home**  (accueil) ou **Back**  (précédent), vos modifications ne seront pas enregistrées.

- ① Appuyez pour modifier le point d'accès sans fil.
- ② État actuel de la connexion sans fil.
- ③ Appuyez pour modifier le type de sécurité sans fil.
- ④ Appuyez pour modifier le mot de passe sans fil.



Lors de la connexion à votre réseau sans fil, l'icône **Wi-Fi**  située dans le coin inférieur droit de l'écran du programmeur clignote. La connexion prend environ 30 secondes et, une fois la connexion au **Wi-Fi**  établie, l'icône cesse de clignoter.

IT Connessione del programmatore a Internet con la connessione guidata

Selezionate la rete wireless dall'elenco mostrato sul display del programmatore e premete il pulsante **Confirm** (Conferma) sullo schermo. Immettete la password della rete wireless e premete il pulsante **OK** sulla tastiera.

! Importante: se la rete non è presente nell'elenco, verificate che l'unità si trovi nel campo di portata del segnale wireless. Accertatevi di premere il pulsante **OK** dopo aver inserito la password. La pressione dei pulsanti **Home**  o **Back**  (Indietro) non comporta il salvataggio delle modifiche.



- ① Toccate per modificare il punto di accesso wireless.
- ② Stato corrente della connessione wireless.
- ③ Toccate per modificare il tipo di sicurezza wireless.
- ④ Toccate per modificare la password wireless.

Durante la connessione alla rete wireless, l'icona **Wi-Fi**  nella parte inferiore destra della schermata del programmatore inizierà a lampeggiare. La connessione richiede circa 30 secondi. Al termine, l'icona **Wi-Fi**  risulterà fissa.



PT Conecte seu controlador à internet usando o assistente de conexão

Na tela do controlador, selecione sua rede de internet sem fio na lista e pressione o botão **Confirm** (**confirmar**). Insira a senha e pressione o botão **OK** no teclado.

! Importante: Se o seu Wi-Fi não estiver aparecendo na lista, verifique se o controlador está dentro do raio de alcance do Wi-Fi. Não se esqueça de pressionar o botão **OK** depois de inserir a senha.



Se você pressionar os botões **Home**  (início) ou **Back**  (voltar), suas alterações não serão salvas.

- ① Toque para alterar o ponto de acesso do Wi-Fi.
- ② Status atual do Wi-Fi.
- ③ Toque para alterar o tipo de segurança do Wi-Fi.
- ④ Toque para alterar a senha.



Durante a conexão com a rede sem fio, o ícone do **Wi-Fi** , localizado na parte inferior direita da tela do controlador, irá piscar. A conexão leva cerca de 30 segundos para ser realizada. Depois disso, o ícone do **Wi-Fi**  permanecerá constante.

RU Подключение контроллера к Интернету с помощью мастера подключения

Выберите вашу беспроводную сеть из списка, отображаемого на экране контроллера, и нажмите экранную кнопку **Confirm** (Подтвердить). Введите пароль вашей беспроводной сети и нажмите кнопку **OK** на клавиатуре.



Важно! Если ваша сеть отсутствует в списке, убедитесь, что устройство находится в зоне действия сети. После ввода пароля обязательно нажмите кнопку **OK**. При нажатии кнопок **Home**  (Главный экран) или **Back**  (Назад) изменения не сохраняются.

- ① Нажмите для изменения беспроводной точки доступа.
- ② Текущий статус беспроводного соединения.
- ③ Нажмите, чтобы изменить тип безопасности беспроводной сети.
- ④ Нажмите, чтобы изменить пароль беспроводной сети.



При подключении к вашей беспроводной сети пиктограмма **Wi-Fi**  в нижней правой части контроллера начнет мигать. Подключение длится около 30 с, после успешного подключения пиктограмма **Wi-Fi**  будет гореть постоянно.

TR Kontrol Ünitenizin Bağlantı Sihirbazını Kullanarak İnternet'e Bağlanması

Kontrol ünitesi ekranındaki listeden kablosuz ađınızı seçin ve ekrandaki **Confirm** (Onayla) düğmesine basın. Kablosuz bağlantı şifrenizi (password) girin ve klavyedeki **OK** (Tamam) düğmesine basın.

! Önemli: Ađınız listede görünmüyorsa ünitenin kablosuz ađ kapsama alanında olup olmadığını kontrol edin. Parolanızı (password) girdikten sonra **OK** (Tamam) düğmesine bastığınızdan emin olun. **Home**  (Ana Ekran) veya **Back**  (Geri) düğmelerine basarsanız deđişiklikleriniz kaydedilmez.

- ① Kablosuz erişim noktasını deđiştirmek için dokunun.
- ② Mevcut kablosuz ađ bağlantı durumu.
- ③ Kablosuz ađ güvenlik türünü deđiştirmek için dokunun.
- ④ Kablosuz ađ şifresini deđiştirmek için dokunun.

Kablosuz ađınıza bağlanırken kontrol ünitesinin sağ alt kısmındaki **Wi-Fi**  simgesi yanıp sönecektir. Bağlanma işlemi yaklaşık 30 saniye sürer ve bağlantı başarıyla gerçekleştirildiğinde **Wi-Fi**  simgesi sabit kalacaktır.

U.S. FCC Statement

This equipment has been tested and found to comply with the limits for a Class B digital device, pursuant to part 15 of the FCC Rules. These limits are designed to provide reasonable protection against harmful interference in a residential installation. This equipment generates, uses and can radiate radio frequency energy, and if not installed and used in accordance with the instructions, may cause harmful interference to radio communications. However, there is no guarantee that interference will not occur in a particular installation. If this equipment does cause harmful interference to radio or television reception, which can be determined by turning the equipment off and on, the user is encouraged to try to correct the interference by one or more of the following measures:

- Reorient or relocate the receiving antenna.
- Increase the separation between the equipment and receiver.
- Connect the equipment into an outlet on a circuit different from where the receiver is connected.
- Consult the dealer or an experienced radio/TV technician for help.

To satisfy FCC RF Exposure requirements for mobile and base station transmission devices, a separation distance of 8" (20 cm) or more should be maintained between the antenna of this device and persons during operation. To ensure compliance, operation at closer than this distance is not recommended. The antenna(s) used for this transmitter must not be co-located or operating in conjunction with any other antenna or transmitter.

Certificate of Conformity to European Directives

Hunter Industries declares that the irrigation controller Model HCC complies with the standards of the European Directives of “electromagnetic compatibility” (2014/30/EU), “low voltage” (2014/35/EU) and “radio equipment” (2014/53/EU).



Innovation, Science and Economic Development Canada (ISED) Compliance Notice

This device contains licence-exempt transmitter(s)/receiver(s) that comply with Innovation, Science and Economic Development Canada's licence-exempt RSS(s). Operation is subject to the following two conditions:

1. This device may not cause interference, and
2. This device must accept any interference, including interference that may cause undesired operation of the device.

Déclaration d'Industrie Canada

Le présent appareil est conforme aux CNR d'Innovation, Sciences et Développement économique Canada applicables aux appareils radio exempts de licence. L'exploitation est autorisée aux deux conditions suivantes:

1. L'appareil ne doit pas produire de brouillage, et
2. L'utilisateur de l'appareil doit accepter tout brouillage radioélectrique subi, même si le brouillage est susceptible d'en compromettre le fonctionnement.

Wi-Fi Module Information

Radio module: Microchip Technology Inc.
(model number ATWINC-1500-MR210UB)

Helping our customers succeed is what drives us. While our passion for innovation and engineering is built into everything we do, it is our commitment to exceptional support that we hope will keep you in the Hunter family of customers for years to come.



**Denise Mullikin, President,
Landscape Irrigation and Outdoor Lighting**

HUNTER INDUSTRIES | *Built on Innovation*[®]
1940 Diamond Street, San Marcos, CA 92078 USA
hunterindustries.com