

FX LUMINAIRE

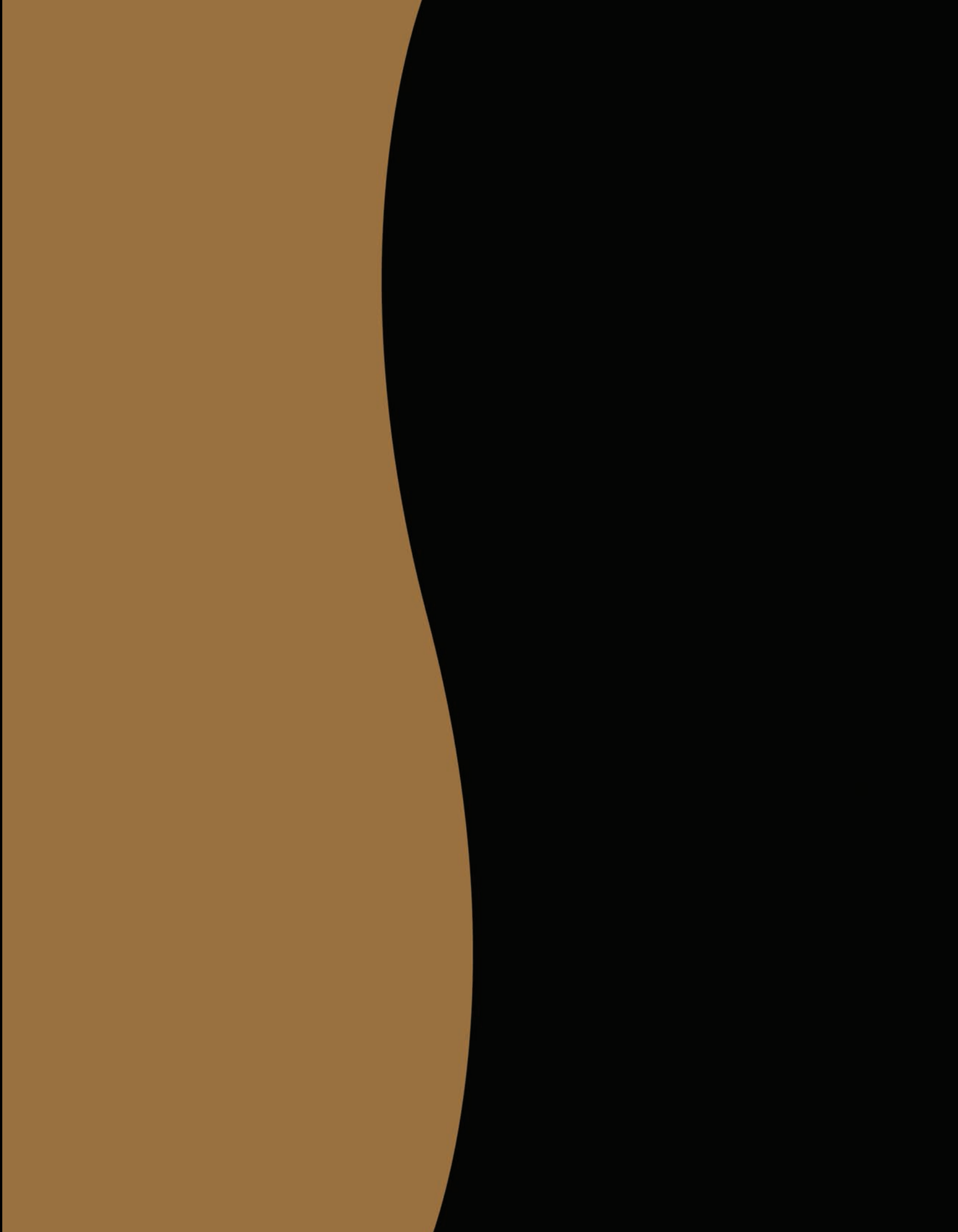

THE FX SPECIFIERS RESOURCE GUIDE



SRG 3.8 TABLE OF CONTENTS

POWER AND CONTROL

PX: PotenzaX®	3
----------------------	---

WALLLITES

CP: CandelaPasso®	5
UN: UccelloNotturmo®	7
LM: LouverMassimo®	9
PD: PanciaDuppio®	11
ML: MicroLuce®	13
CG: CustodeGradino®	15
MM: MolluscoMuro®	17

UPLITES

MP: MetalloPesante®	19
MU: MacchiaUltimo®	21
CM: CaloreMasso®	23
RS: ReflectoreStellato®	25
SI: SpuntareIntimo®	27
CR: CarinoRame®	29
LR: Lustrorame®	31
LO: LampadaOttone®	33
RL: RotondoLuna®	35

DOWNLITES

LS: LunaSonora®	37
VL: Vitelume®	39
TC: TraveCasa®	41
CL: CopertinaLuce®	43
TS: TrellisSolare®	45

PATHLITES

DP: DiamantePiccolo®	47
SP: SaguaroPetite®	49
AP: AllegroPianta®	51
BD: BellaDonna®	53
SC: SfericoCaldo®	55
EA: ElfoAngoloso®	57
PR: PettoRisoluto®	59
PF: PezzoForte®	61
PV: PiattinoVestito®	63
DL: DemiLite®	65
AN: ArtistaNuovo®	67
DM: DelMare®	69
CB: CapelliBiondi®	71
CA: CrescenteAlba®	73
CV: CapolaVoro®	75
QF: QuadratoFidato®	77
GN: GrandezzaNaturale®	79
GT: GuscioTartaruga®	81
FG: FaroGiardino®	83
TD: TulipanoD'oro®	85
AL: AccentoLume®	87
PM: PostModerne®	89
DR: DellaRibalta®	91
DS: DuroStrato®	93

SPECIALTY

TE: TerraElemento®	95
CF: CratereFurbo®	97
FC: FavolosoCaverna®	99
RP: ResistentePilotare®	101
SM: StellaMinuto®	103
LB: LagoBrillante®	105

REFERENCE

Mounting Options	107
Lamps	109
Photometrics	110
Glossary	111

FX Luminaire Warranty Policy

Transformers

All FX Luminaire Transformers are warranted from manufacturer's defects for a period of ten years from the date of installation. If a transformer should fail due to manufacturing defects within this period, FX Luminaire will repair or replace the faulty unit free of charge.

Fixture Warranty

All FX Luminaire Low Voltage Lighting Fixtures are warranted from corrosion and/or manufacturer's defect for a period of three years from date of installation. If a fixture should fail due to corrosion or manufacturer's defects, FX Luminaire will repair or replace said fixtures free of charge.

Extended Warranty

FX Luminaire extends the warranty on Fixture and Transformers to ten years from the date of installation when both FX Luminaire fixtures and transformers are installed on the same project exclusive of any competitor's products. If, due to manufacturer's defects, either fixture(s) or Transformer(s) should fail within this period of time, FX Luminaire will repair or replace the faulty equipment free of charge.

Exclusions from the FX Warranty

1. Insignificant defects such as scratches, minor mechanical or electrical maladjustment or any manufacturing error that can be easily corrected.
2. Any defect discovered in a product that has been modified without FX's prior written consent unless the changes are minor.
3. WARRANTY VOID IF FIXTURES ARE USED WITH NON-UL 1838 POWER SUPPLY.

FX Luminaire hereby disclaims all implied warranties and conditions of merchantability, fitness for a particular purpose, title and non-infringement. In no event shall FX Luminaire and/or its respective suppliers be liable for any special, indirect or consequential damages or any damages whatsoever resulting from loss of use, profits, whether in an action of contract, negligence or other tortious action, arising out of or in connection with the use or performance of FX products. Installation labor to repair or replace defective products is explicitly excluded from the FX product warranty.

Warranty Detail

1. A description of the failure of the products found to be defective should be provided to FX within thirty (30) days from the time the defective item is given to the branch.
2. All defects are subject to verification by FX Luminaire.
3. All items must be returned with an RMA.
4. All defective items must be returned to FX within twenty four hours from the time an RMA is issued.

Returned Merchandise Authorization

A Returned Merchandise Authorization (RMA) must be issued by an authorized FX Luminaire representative prior to returning fixtures, transformers or accessories to the factory.

FX | LUMINAIRE®

INTRODUCTION



Welcome to the current edition of our Specifiers Resource Guide. We have worked hard to make it the most comprehensive and easy-to-use guide to specifying landscape lighting in the industry. It is packed with everything you need to make an informed decision about which of our products to use. This resource guide will provide you with a profile and environmental picture of every product, brief descriptions of how it is best used, lamp, finish and accessory options, and how to properly spec the product to insure clear communication with the field installer. This introduction was created to help you better understand the enormous amount of information contained in this catalog.

LINE DRAWING

Line drawings and dimensions are featured on every product page. Some of our pathlites have additional riser options which allows the product to be taller or shorter to fit your plant height needs. The TulipanoD'oro®, shown below, is available in two heights: standard and extra tall.

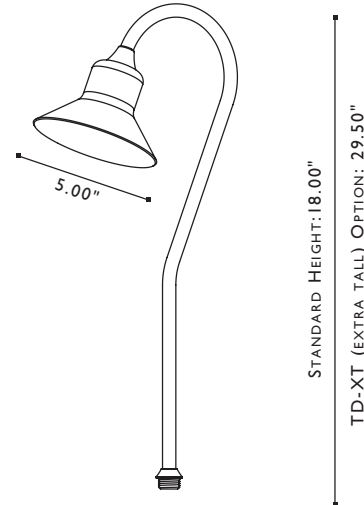

PRODUCT SECTIONS

There are seven main groups of products that we offer. They are denoted by a symbol in the top right on the front of every product page.

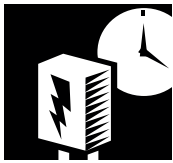

POWER & CONTROL

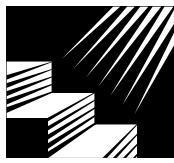

WALL LIGHTING

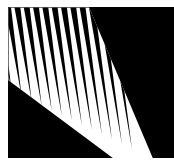

UPLIGHTING



DOWNLIGHTING

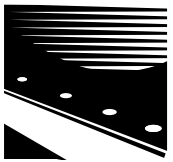

PATH LIGHTING



SPECIALTY LIGHTING

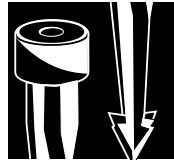

ACCESSORIES

EFFECT SYMBOLS

The bottom left on the front of every product page has symbols which are used to denote how every product can be utilized.

EFFECTS



ARCHITECTURAL ACCENTS



SHADOWING



WALL WASHING



10-YEAR WARRANTY

Every product in this guide is backed by our industry-leading, 10-year warranty. No other lighting manufacturer has the confidence in their products to offer this type of guarantee because no other manufacturer has worked so hard to identify and resolve potential problems before they occur. Our commitment to designing and fabricating the very finest components assures your clients years of trouble-free enjoyment from their FX lighting system.



WHERE TO BUY

For information on where to buy, visit our web site at www.FXL.com or contact our friendly customer service at 800-688-1269.

START BROWSING

So, go ahead, browse the pages, pick a product, and spec it. Contact your local distributor and soon you will have in your hands some of the greatest products the industry has to offer.

ORDERING INFORMATION

The back of every product page details what options are available for each fixture, and how to spec them. For example, the MicroLuce® is available with a Halogen lamp. More information on the lamp options is in the next column labeled "Description." The items in blue boxes denote what you will need to spec. See the next section "How to Order."

AVAILABLE LAMP CONFIGURATIONS:

Your choice of one lamp will come pre-installed.

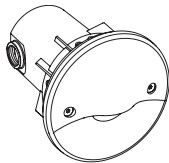
FIXTURE/CODE	WATTAGE/CODE	DESCRIPTION
1 ML	2 HALOGEN (H) LAMP OPTIONS:	
	20H	20 watt Halogen, wide 32° beam Avg. life 2000 hours

OPTIONS

Also on the product page could be options for lens optics, including spread, clear and colored lenses, as well as mounting options including spikes, VersaBox®, and post mount. Some pathlites have additional riser options which allows the product to be taller or shorter to fit your plant height needs. Every product has its own specialized set of options.



PHOTOMETRICS

If available for that fixture, the photometrics will be on the back of the product page. Photometrics provide you with suggestions on how far apart products should be spaced to give you your desired light output. The spacing are general suggestions – actual site conditions, safety concerns and elevations can effect light quality and spacing. Use this section as a general guide only.

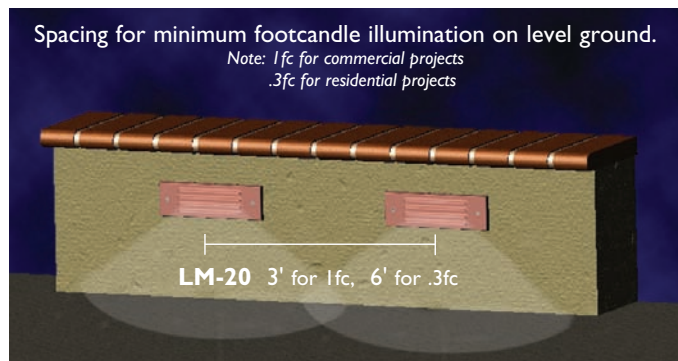

ORDERING SAMPLE:

SECTIONS:	DESCRIPTION:	WHAT TO ORDER:
1 + 2 + 3 optional	 +  + 	= ML-20H

The box at the top of the page shows you a sample order. For example, if you wanted a 20 watt Wide beam spread ML in copper, you would spec ML-20H. ML for MicroLuce®, 20H for the wattage, and it comes standard in brass. The available finishes are listed in the section called "Finish Options." If you would like a ML-20 in Verde, then you would spec ML-20H-VF. The more options that are available, and the more options you choose, the longer the code sequence is.



For example, the ReflectoreStellato® ordering code sequence will be much more detailed than the ML. This nomenclature ensures accurate quote and installations.

FINISH OPTIONS







When stated that our products are brass and copper, this means that they are made from actual raw brass and copper – not aluminum coated to look like brass or copper. See the back of individual product information pages for more information on which options are available for that fixture.

RAW MATERIALS:

Copper and Brass are raw materials, not powdercoats.

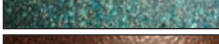
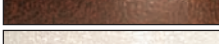
	CODE	DESCRIPTION
	CU	Copper <i>(will naturally patina)</i>
	BS	Brass <i>(will naturally patina)</i>

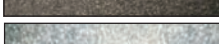
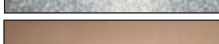
FINISH OPTIONS:

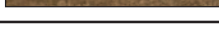
	BZ	Bronze Metallic
	DG	Desert Granite
	BF	Black Wrinkle
	VF	Verde Speckle
	SB	Sedona Brown
	WF	White Wrinkle
	WI	Weathered Iron
	NP	Nickel Plate <i>(Copper or Brass fixtures only)</i>
	DT	Desert Tan <i>(Composite fixtures only)</i>
	CB	Camo Bronze <i>(Composite fixtures only)</i>

FX | LUMINAIRE®
PX-300, PX-600, PX-900

POWER &
 CONTROL



**SAFE, COMPLIANT
 AND INNOVATIVE**

This is the high tech heart of the FX Luminaire® low voltage lighting system. The patented PX is available in 300, 600 and 900 watt capacities with a variety of control options. The enclosure is fabricated from heavy gauge stainless steel for long life in corrosive exterior locations.

A critical function of a transformer is to supply the halogen lamps with a constant non-fluctuating voltage current to prevent premature lamp burnout. Any well designed lighting system starts with a solid power supply that will provide safe, clean power to energy-efficient components — the FX PotenzaX® is engineered for the task.

An important consideration in designing a lighting system is how it will be actuated. FX offers open switching control architecture. Use any standard timer, photocell, manual switch or “smart home” device to control the transformer.

U.S. Patents No. 6,443,783; 6,497,592
 Other patents pending.

POTENZAX® | FX LUMINAIRE®



INSTALLATION FLEXIBILITY

Over 16 years ago, FX introduced the industry's first multi-tap landscape lighting transformer. The multi-tap feature allows the field installer to compensate for voltage loss from different cable run lengths, thereby balancing the system for high performance and maximum lamp life. The longer the run, the higher the initial voltage to compensate for voltage loss. FX continues to be the industry innovator by introducing the SuperBloX² terminal. This patented component allows the installer to safely connect the field wires to the power supply and provides 120 volt switching control options that are unmatched. Specify the cutting edge of power supplies — the FX PotenzaX®!

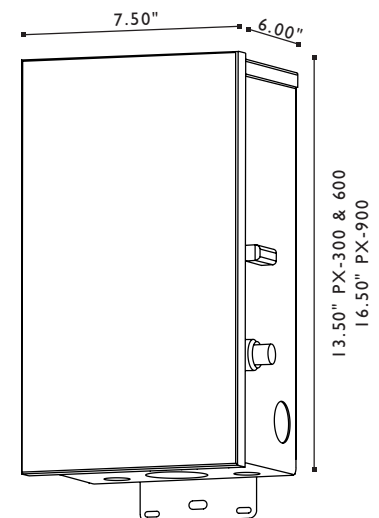

POWER &
 CONTROL



POTENZA[®] – ORDERING INFORMATION

The PX comes in Stainless Steel (SS), and your choice of Cord and/or Timer and/or Photocell.

STANDARD PARTS:

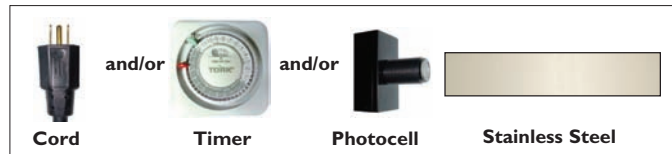

ORDERING SAMPLE:

SECTIONS:	DESCRIPTION:	WHAT TO ORDER:
1 + 2 + 3 <small>optional</small>	+ 300 +	= PX-300-T

STANDARD OPTIONS:

1 + 2 + 3 ORDERED TOGETHER ON SAME LINE

AVAILABLE CONFIGURATIONS:

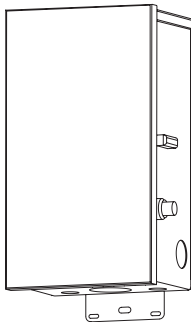
FIXTURE/CODE	WATTAGE/CODE	DESCRIPTION
1 PX 	2	300-C With 3' power cord
		300-T With 3' power cord and internal Timer
		300-PC With 3' power cord and PhotoCell
		300-TPC With 3' power cord and PhotoCell and internal Timer
		600-C With 3' power cord
		600-T With 33' power cord and internal Timer
		600-PC With 33' power cord and PhotoCell
		600-TPC With 33' power cord and PhotoCell and internal Timer
		900-C With 33' power cord
		900-T With 3' power cord and internal Timer
		900-PC With 3' power cord and PhotoCell
		900-TPC With 3' power cord and PhotoCell and internal Timer

STANDARD FINISH OPTIONS:

Stainless Steel is standard. All other choices must be specified.

CODE	DESCRIPTION
SS	Stainless Steel

NON-STOCKING FINISH OPTIONS:

Allow extra time for the following finish options:

	3 BZ	Bronze Metallic
	DG	Desert Granite
	BF	Black Wrinkle
	VF	Verde Speckle
	SB	Sedona Brown
	WF	White Wrinkle
	WI	Weathered Iron

OPEN SWITCHING CONTROL ARCHITECTURE



Switching control is one of the most important tasks the lighting designer must address in order to have the system fit the owner's lifestyle and utility needs. To allow for the widest creative control, FX has designed the PotenzaX[®] with an open architecture for switching controls. This allows the specifier to incorporate a wide variety of electro-mechanical or digital controls that can even tie in the landscape lighting to a full home automation system.

Products such as the Leviton[®] Decora Home Controls or X-10 will work well with the PotenzaX[®] Transformer. These components can be easily installed into new or remodeled projects as they use the existing house wiring to transmit signals.



If you have a sharp job site electrician, he/she can utilize the PotenzaX[®] SuperBloX terminal to create manual overrides or three-way switching. For larger projects, such as resorts, the PX can be in-line mounted and wired in-series with a central timer and/or photocell.

No other transformer manufacturer offers the professional lighting designer this wide range of switching options. To learn more about this important topic, and to print out a client switching questionnaire form in order to help you discover their needs, visit our website at: www.FXL.com

SAFETY STANDARDS

ETL Listed to UL Standards For Safety:

ETL 1838 LANDSCAPE
ETL 379 POOL & SPA



For high performance and predictable lamp life use FX LUMINAIRE[®] Transformers only. The FX PX is specifically designed for the high tech lamps used in our fixtures — the use of inferior power supplies can cause premature lamp failure and other problems including the risk of fire. For more information on this very important subject please contact us at 800-688-1269 or on the web, for the booklet entitled "Understanding UL Listing Standards for Low Voltage Landscape Lighting."

FX | LUMINAIRE®
CP-10

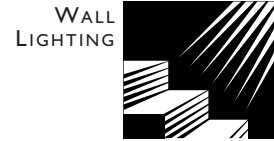

COMMERCIAL QUALITY,
RESIDENTIAL PRICE POINT

The patent pending CP is engineered to bring light to areas such as walkways, stairways and decks as well as to other foot traffic hazards that don't have an adjacent planter area for pathlighting or trees and trellis from which to downlight.

Incorporated into the design is the LevelX® feature. The LevelX® assures the lighting installer that the faceplates of these permanently mounted fixtures will remain perfectly level upon completion of the installation. Many step and wall lights on the market today are designed so that if the mounting box is installed out-of-level, the faceplate, once installed, will also be noticeably out-of-level.

Some of the features of the CP include: Sleeve is permanently mounted in concrete or wood wall combined with multiple threaded knockouts, easy-to-remove box for unforeseen future problems prevents having to chip away at the wall for repairs, and corrosion-free stainless steel inserts.

CANDELAPASSO® | FX LUMINAIRE®

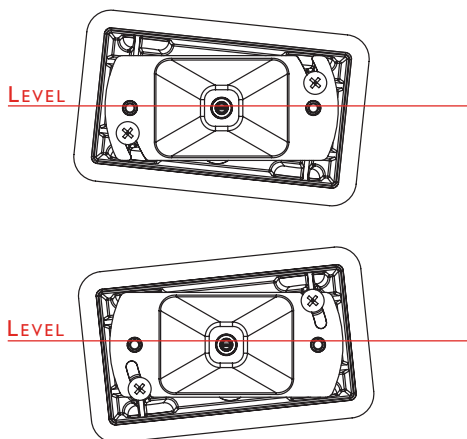

PERFECTION EVERY TIME

The Patent Pending LevelX® system allows the composite sleeve to be up to 3/8" out of level, in either direction, while still allowing the faceplate to be laser level!

The secret: The trim attaches to the adjustable reflector assembly – not the composite sleeve or body. Heavy foam gasket keeps light spill to a minimum.

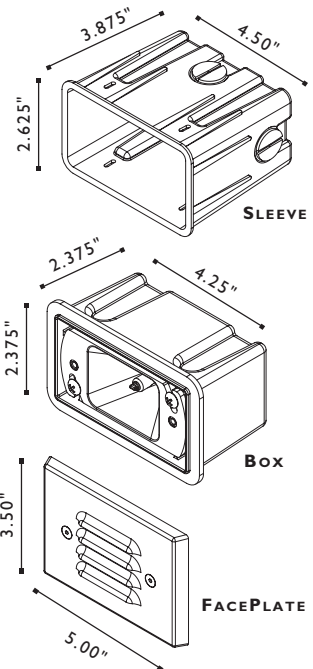

STAIRWAY LIGHTING

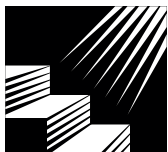

PERIMETER LIGHTING



CANDELA PASSO® ORDERING INFORMATION

The CP comes standard with a 10 watt Xenon G4 and a copper faceplate.

STANDARD PARTS:



ORDERING SAMPLE:

SECTIONS:	DESCRIPTION:	WHAT TO ORDER:
1 + 2 + 3	+ +	= CP-10-CU

STANDARD OPTIONS:

1 + 2 + 3 ORDERED TOGETHER ON SAME LINE

AVAILABLE LAMP CONFIGURATIONS:

Your choice of lamp will come pre-installed.

FIXTURE/CODE	WATTAGE/CODE	AVG. LIFE HOUR
1 CP 	2 XENON LAMP OPTIONS: 10	10,000

STANDARD FINISH OPTIONS: CANDELAPASSO

Copper is standard. All other choices must be specified.

	CODE	DESCRIPTION
	CU	Copper <i>(will naturally patina)</i>

NON-STOCKING FINISH OPTIONS: CP

Allow extra time for the following finish options:

	3 BZ	Bronze Metallic
	DG	Desert Granite
	BF	Black Wrinkle
	VF	Verde Speckle
	SB	Sedona Brown
	WF	White Wrinkle
	WI	Weathered Iron
	NP	Nickel Plate

PHOTOMETRICS:

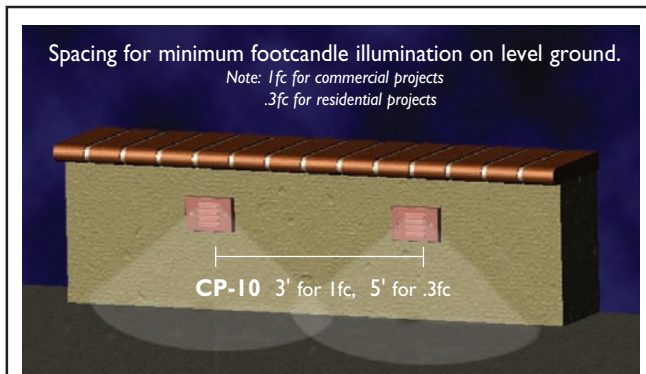

wall	φ
2'	
4'	
6'	
8'	

FOOTCANDLE POWER:

Distance from Center	CP-10
1'	.5
2'	.4
3'	.16

For conversion to lumens: Multiply footcandles x 10. See FX glossary for a full description of fc and lumens.

FX | LUMINAIRE®
UN-10



COMMERCIAL QUALITY,
RESIDENTIAL PRICE POINT

The patent pending UN is engineered to bring light to areas such as walkways, stairways and decks as well as to other foot traffic hazards that don't have an adjacent planter area for pathlighting or trees and trellis from which to downlight.

Incorporated into the design is the LevelX® feature. The LevelX® assures the lighting installer that the faceplates of these permanently mounted fixtures will remain perfectly level upon completion of the installation. Many step and wall lights on the market today are designed so that if the mounting box is installed out-of-level, the faceplate, once installed, will also be noticeably out-of-level.

Some of the features of the UN include: Sleeve is permanently mounted in concrete or wood wall combined with multiple threaded knockouts, easy-to-remove box for unforeseen future problems prevents having to chip away at the wall for repairs, and corrosion-free stainless steel inserts.



UCCELLONOTTURNO® | FX LUMINAIRE®

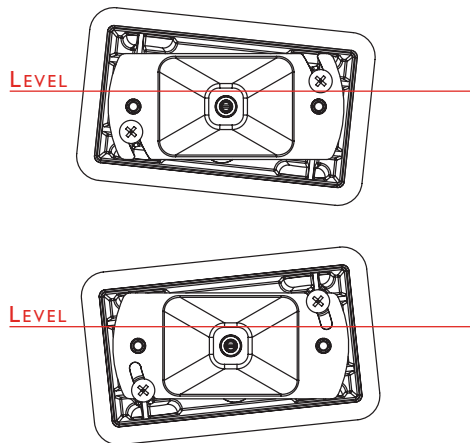

PERFECTION EVERY TIME

The Patent Pending LevelX® system allows the composite sleeve to be up to 3/8" out of level, in either direction, while still allowing the faceplate to be laser level!

The secret: The trim attaches to the adjustable reflector assembly – not the composite sleeve or body. Heavy foam gasket keeps light spill to a minimum.

STAIRWAY LIGHTING



PERIMETER LIGHTING

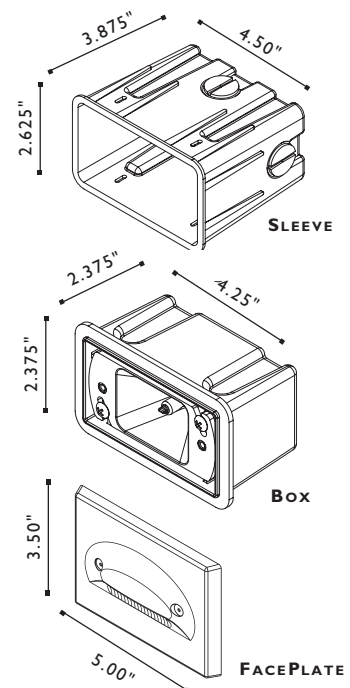

UCCELLONOTTURNO® – ORDERING INFORMATION

The UN comes standard with a 10 watt Xenon G4 and any choice of finish.

STANDARD PARTS:



ORDERING SAMPLE:

SECTIONS:	DESCRIPTION:	WHAT TO ORDER:
1 + 2 + 3	+ +	= UN-10-CB

STANDARD OPTIONS:

1 + 2 + 3 ORDERED TOGETHER ON SAME LINE

AVAILABLE LAMP CONFIGURATIONS:

Your choice of lamp will come pre-installed.

FIXTURE/CODE	WATTAGE/CODE	AVG. LIFE HOUR
1 UN 	2 XENON LAMP OPTIONS: 10	10,000

FINISH OPTIONS:

Choose from the following finish options:

	3 BS	Brass <i>(will naturally patina)</i>
	BZ	Bronze Metallic
	DG	Desert Granite
	BF	Black Wrinkle
	VF	Verde Speckle
	SB	Sedona Brown
	WF	White Wrinkle
	WI	Weathered Iron
	NP	Nickel Plate

COMPOSITE FINISH OPTIONS:

Choose from the following finish options:

	CODE	DESCRIPTION
	3 CB	Camo Bronze
	DT	Desert Tan

Note: Composite finishes can not be powdercoated.

FX | LUMINAIRE®
LM-20

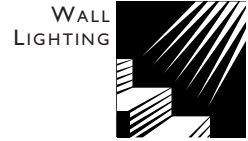

COMMERCIAL QUALITY,
RESIDENTIAL PRICE POINT

The patent pending LM is engineered to bring light to areas such as walkways, stairways and decks as well as to other foot traffic hazards that don't have an adjacent planter area for pathlighting or trees and trellis from which to downlight.

Incorporated into the design is the LevelX® feature. The LevelX® assures the lighting installer that the faceplates of these permanently mounted fixtures will remain perfectly level upon completion of the installation. Many step and wall lights on the market today are designed so that if the mounting box is installed out-of-level, the faceplate, once installed, will also be noticeably out-of-level.

Some of the features of the LM include: Sleeve is permanently mounted in concrete or wood wall combined with multiple threaded knockouts, easy-to-remove box for unforeseen future problems prevents having to chip away at the wall for repairs, and corrosion-free stainless steel inserts.

LOUVERMASSIMO® | FX LUMINAIRE®

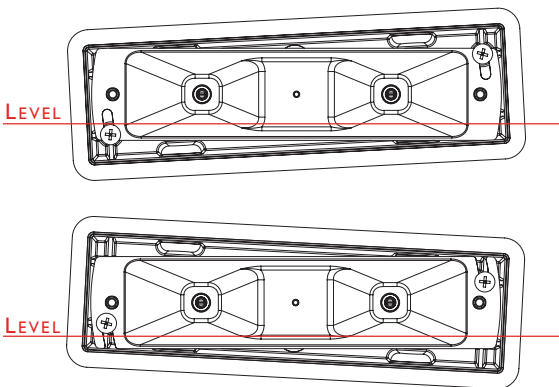

PERFECTION EVERY TIME
The Patent Pending LevelX® system allows the composite sleeve to be up to 3/8" out of level, in either direction, while still allowing the faceplate to be laser level!

The secret: The trim attaches to the adjustable reflector assembly – not the composite sleeve or body. Heavy foam gasket keeps light spill to a minimum.

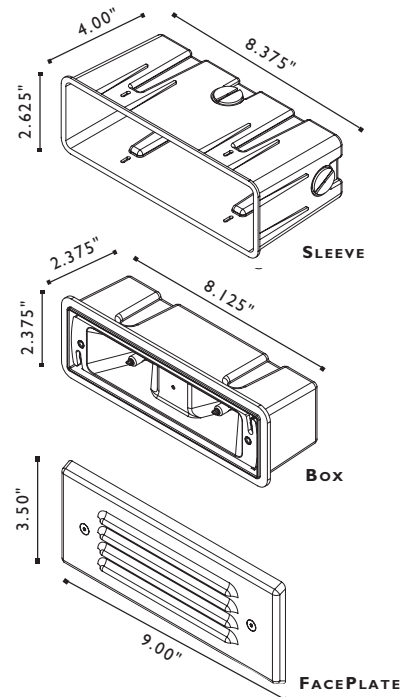

STAIRWAY
LIGHTING



PERIMETER
LIGHTING



LOUVERMASSIMO® – ORDERING INFORMATION

The LM comes standard with two 10 watt Xenon G4 and a Copper faceplate.

STANDARD PARTS:

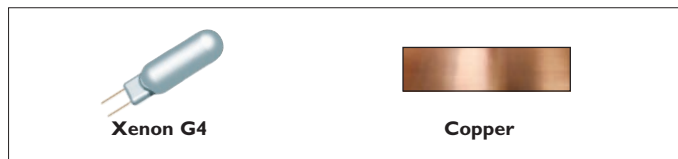

STANDARD OPTIONS:

1 + 2 + 3 ORDERED TOGETHER ON SAME LINE

AVAILABLE LAMP CONFIGURATIONS:

Your choice of lamp will come pre-installed.

FIXTURE/CODE	WATTAGE/CODE	AVG. LIFE HOUR
--------------	--------------	----------------

1	LM	2	XENON LAMP OPTIONS:	
		20 (2 x 10 watts)		10,000





STANDARD FINISH OPTIONS: LOUVERMASSIMO

Copper is standard. All other choices must be specified.

	CODE	DESCRIPTION
	CU	Copper <i>(will naturally patina)</i>

NON-STOCKING FINISH OPTIONS: LOUVERMASSIMO

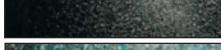
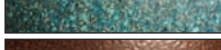
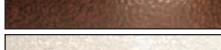
Allow extra time for the following finish options:

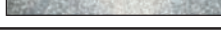
	3		
	BZ	Bronze Metallic	
	DG	Desert Granite	
	BF	Black Wrinkle	
	VF	Verde Speckle	
	SB	Sedona Brown	
	WF	White Wrinkle	
	WI	Weathered Iron	
	NP	Nickel Plate	

ORDERING SAMPLE:

SECTIONS:	DESCRIPTION:	WHAT TO ORDER:
1 + 2 + 3 <small>optional</small>	 +  + 	= LM-20-CU

PHOTOMETRICS:

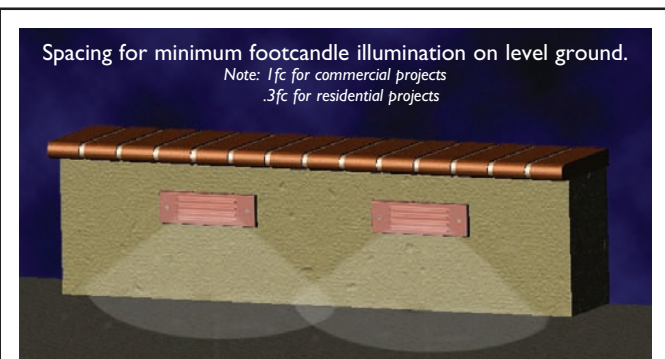

wall	φ
2'	
4'	
6'	
8'	

Footcandle Power

Distance from Center	LM-20
1'	4.3
2'	1.3
3'	.50
4'	.25
5'	.18
6'	.12

For conversion to lumens: Multiply footcandles x 10. See FX glossary for a full description of fc and lumens.

FX | LUMINAIRE®
PD-20



COMMERCIAL QUALITY,
 RESIDENTIAL PRICE POINT

The patent pending PD is engineered to bring light to areas such as walkways, stairways and decks as well as to other foot traffic hazards that don't have an adjacent planter area for pathlighting or trees and trellis from which to downlight.

Incorporated into the design is the LevelX® feature. The LevelX® assures the lighting installer that the faceplates of these permanently mounted fixtures will remain perfectly level upon completion of the installation. Many step and wall lights on the market today are designed so that if the mounting box is installed out-of-level, the faceplate, once installed, will also be noticeably out-of-level.

Some of the features of the PD include: Sleeve is permanently mounted in concrete or wood wall combined with multiple threaded knockouts, easy-to-remove box for unforeseen future problems prevents having to chip away at the wall for repairs, and corrosion-free stainless steel inserts.

PANCIADUPPIO® | FX LUMINAIRE®

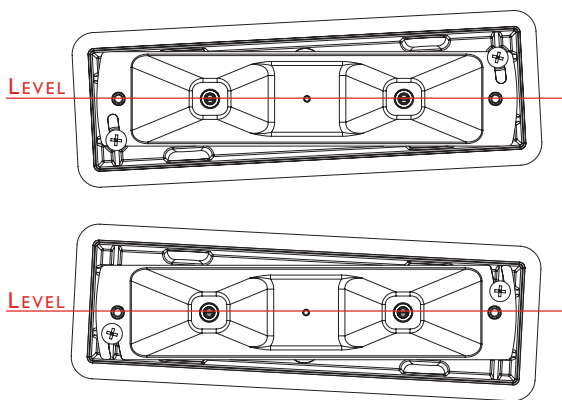

PERFECTION EVERY TIME
 The Patent Pending LevelX® system allows the composite sleeve to be up to 3/8" out of level, in either direction, while still allowing the faceplate to be laser level!

The secret: The trim attaches to the adjustable reflector assembly – not the composite sleeve or body. Heavy foam gasket keeps light spill to a minimum.

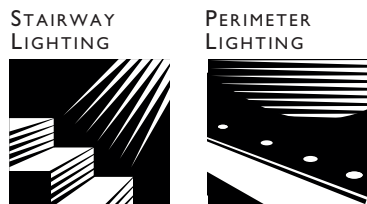
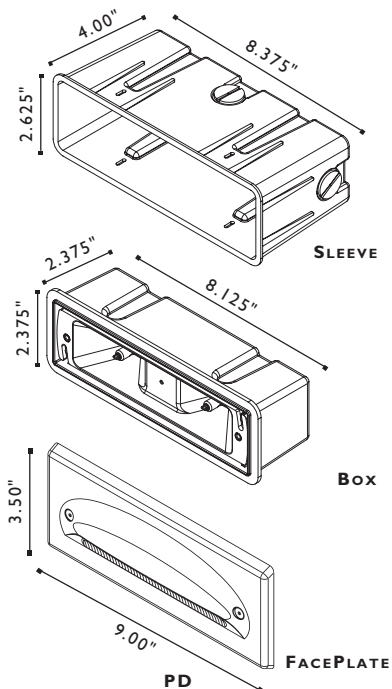

PANCIADUPPIO® – ORDERING INFORMATION

The PD comes standard with two 10 watt Xenon G4 and a faceplate with a finish of your choice.

STANDARD PARTS:



ORDERING SAMPLE:

SECTIONS:	DESCRIPTION:	WHAT TO ORDER:
1 + 2 + 3	+ +	= PD-20-CB

STANDARD OPTIONS:

1 + 2 + 3 ORDERED TOGETHER ON SAME LINE

AVAILABLE LAMP CONFIGURATIONS:

Your choice of lamp will come pre-installed.

FIXTURE/CODE	WATTAGE/CODE	DESCRIPTION
1 PD 	2 XENON LAMP OPTIONS:	
	20 (2 x 10 watts)	10,000

FINISH OPTIONS:

Choose from the following finish options:

	3	BS	Brass <i>(will naturally patina)</i>
		BZ	Bronze Metallic
		DG	Desert Granite
		BF	Black Wrinkle
		VF	Verde Speckle
		SB	Sedona Brown
		WF	White Wrinkle
		WI	Weathered Iron
		NP	Nickel Plate

COMPOSITE FINISH OPTIONS:

Choose from the following finish options:

	CODE	DESCRIPTION	
	3	CB	Camo Bronze
		DT	Desert Tan

Note: Composite finishes can not be powdercoated.

FX | LUMINAIRE®
ML-20



ORGANIC SHAPE,
ENGINEERED QUALITY

The FX Luminaire® halogen lamp MicroLuce® was developed to fill the need for an unobtrusive specification grade wall light that would introduce glare-free illumination onto safety and circulation areas.

This patent pending 12v unit is a perfect choice for high traffic public areas or walls near people-water such as resort applications. An innovative adjustable lamp mount allows the installer to fine tune beam projection to suit project needs.

Solid brass and composite construction make this model a lasting value. Its deep cowling and recessed lamp position, when located and installed properly, allows pedestrians to view uphill without dangerous glare. Obviously, glare-free illumination should be the primary function of any fixture that is designed to provide safe passage through foot traffic hazards.

MICROLUCE® | FX LUMINAIRE®

BLENDS IN ANYWHERE

The solid brass faceplate trim has an organic shape that doesn't speak of a specific architecture which allows the MicroLuce® to be specified on projects of all ages.

Brass will develop a penny brown or moss green patina with age depending on exposure. This process will happen naturally over time or can be accelerated with solution spray. For patina formulas visit our website at www.FXL.com/patina.

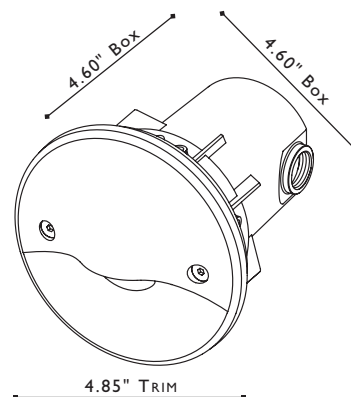

STAIRWAY
LIGHTING



PERIMETER
LIGHTING

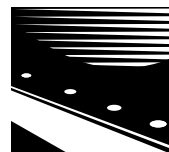

MICROLUCE® – ORDERING INFORMATION

The ML comes standard with 20 watt Halogen AR-11, Spread Lens, and the faceplate in Brass (BS).

STANDARD PARTS:



Halogen AR-11

Spread Lens

Brass

STANDARD OPTIONS:

1 + 2 + 3 ORDERED TOGETHER ON SAME LINE

AVAILABLE LAMP CONFIGURATIONS:

Your choice of one lamp will come pre-installed.

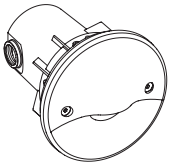
FIXTURE/CODE	WATTAGE/CODE	DESCRIPTION
1 ML 	2 HALOGEN® LAMP OPTIONS:	
	20H	20 watt Halogen, wide, 32° beam, Avg. life 2000 hours





STANDARD FINISH OPTIONS:

Brass is standard. All other choices must be specified.

CODE	DESCRIPTION
 BS	Brass <i>(will naturally patina)</i>

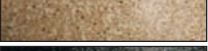
NON-STOCKING FINISH OPTIONS:

Allow extra time for the following finish options:

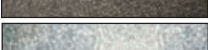
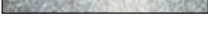
	3 BZ	Bronze Metallic
	DG	Desert Granite
	BF	Black Wrinkle
	VF	Verde Speckle
	SB	Sedona Brown
	WF	White Wrinkle
	WI	Weathered Iron
	NP	Nickel Plate

ORDERING SAMPLE:

SECTIONS:	DESCRIPTION:	WHAT TO ORDER:
1 + 2 + 3 <small>optional</small>	 +  + 	= ML-20H

PHOTOMETRICS:

Spacing for minimum footcandle illumination on level ground.

Note: 1fc for commercial projects
.3fc for residential projects

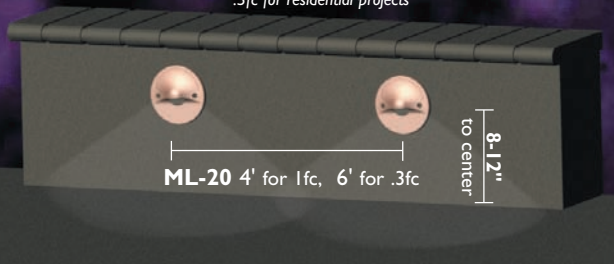

Distance from Center	ML-20
1'	32
2'	8.5
3'	2.1
4'	1.0
5'	.5
6'	.3

For conversion to lumens: Multiply footcandles x 10. See FX glossary for a full description of fc and lumens.

WALL MOUNT INSTALL DETAIL:

INSTALL FX LUMINAIRE MICROLITE AS SHOWN USING 1/2" GAUGE CABLE AND PROVIDED WIRE NUTS.

Install Option A In-wall Direct Burial Method

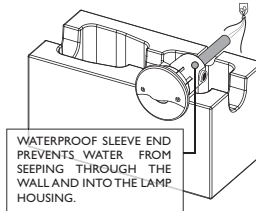

Install Option B In-wall Daisy Chain Method

SECTION/ELEVATION
GRAY (OR BLUE) ENT CONDUIT WITH STRANDED THHN WIRE, SIZED TO MATCH WATTAGE LOAD

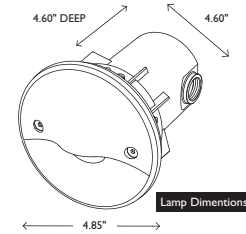
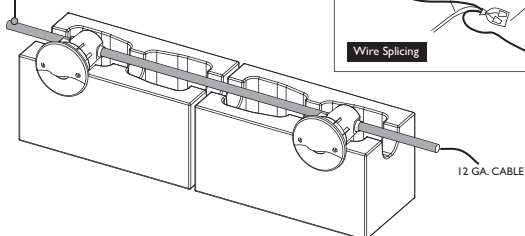

USE FOR HORIZONTAL LIGHTING ONLY!

THIS FIXTURE IS DESIGNED FOR DOWNLIGHTING ONLY!
DO NOT USE FOR UPLIGHTING.

FX | LUMINAIRE®
CG-20

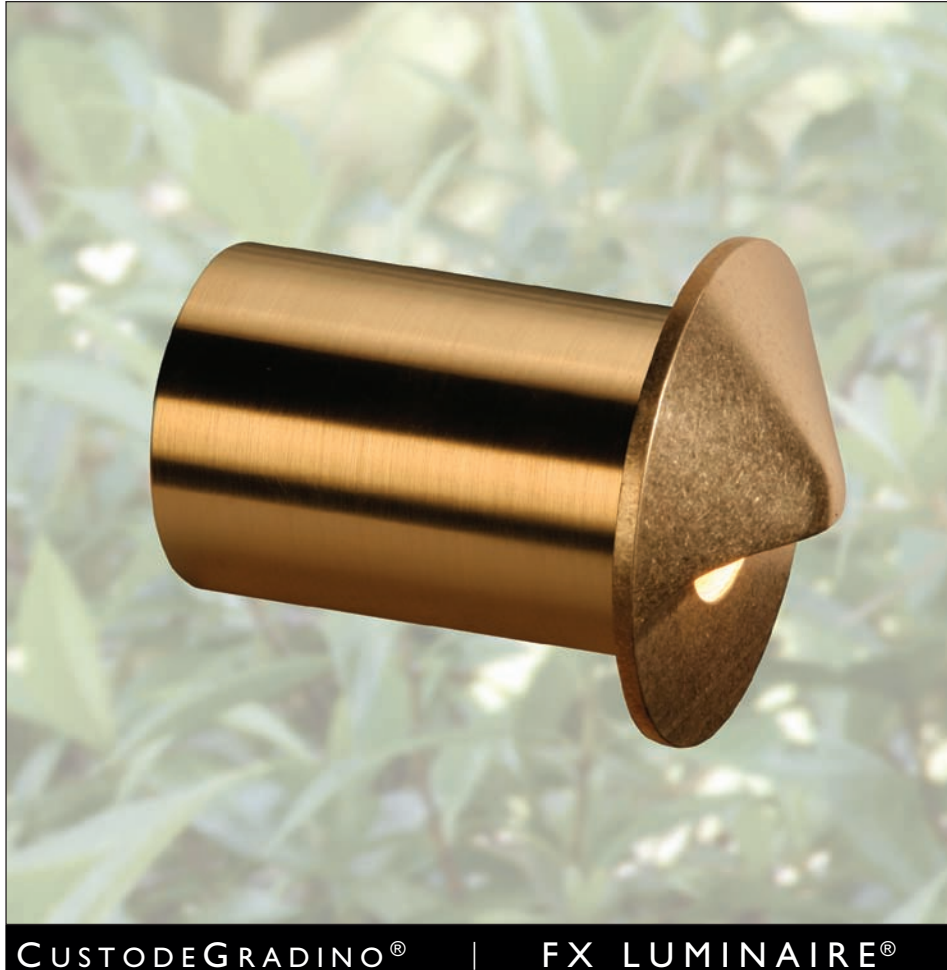

ORGANIC SHAPE,
ENGINEERED QUALITY

The FX Luminaire® halogen lamp CustodeGradino® was developed to fill the need for an unobtrusive specification grade wall light that would introduce glare-free illumination onto safety and circulation areas.

This patent pending 12v unit is a perfect choice for high traffic public areas or walls near people-water such as resort applications. An innovative adjustable lamp mount allows the installer to fine tune beam projection to suit any need.

Solid brass and composite construction make this model a lasting value. Its deep cowling and recessed lamp position allows pedestrians to view uphill without dangerous glare. Obviously, glare-free illumination should be the primary function of any fixture that is designed to provide safe passage through foot traffic hazards.

CUSTODEGRADINO® | FX LUMINAIRE®



TIMELESS BEAUTY

Brass and copper have been used for a thousand years in nautical applications. Naval architects understood and explained the high strength and natural corrosion resistance of these semi-precious metals. The garden environment is as tough and caustic as any found in the high seas.

The copper will patina naturally over time and can be accelerated with solution spray. For patina formulas visit our website at www.FXL.com/patina

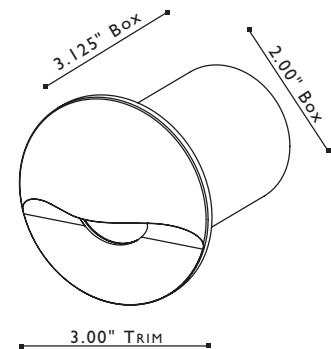

STAIRWAY LIGHTING



PERIMETER LIGHTING



CUSTODEGRADINO® – ORDERING INFORMATION

The CG comes standard with a 20 watt Halogen MR-8 lamp, Clear Lens, and the faceplate in Brass (BS).

STANDARD PARTS:



Halogen MR-8

Clear Lens

Brass

STANDARD OPTIONS:

1 + 2 + 3 ORDERED TOGETHER ON SAME LINE

AVAILABLE LAMP CONFIGURATIONS:

Choose from any watt Halogen (H).

FIXTURE/CODE	WATTAGE/CODE	AVG. LIFE HOUR
1 CG	2 HALOGEN (H) LAMP OPTIONS:	
	20H	20 watt Halogen, wide 42° beam Avg. life 2000 hours
	20H-N	20 watt Halogen, narrow 10° beam Avg. life 2000 hours

STANDARD FINISH OPTIONS:

Brass is standard. All other choices must be specified.

CODE	DESCRIPTION
BS	Brass (will naturally patina)

NON-STOCKING FINISH OPTIONS:

Allow extra time for the following finish options:

	3 BZ	Bronze Metallic
	DG	Desert Granite
	BF	Black Wrinkle
	VF	Verde Speckle
	SB	Sedona Brown
	WF	White Wrinkle
	WI	Weathered Iron
	NP	Nickel Plate

ADDITIONAL LENS OPTIONS:

Comes pre-assembled with a clear lens.

All other lens options will arrive in separate box.

CODE	DESCRIPTION
B S	Spread Lens

ORDERING SAMPLE:

SECTIONS:	DESCRIPTION:	WHAT TO ORDER:
1 + 2 + 3 optional		= CG-20

PHOTOMETRICS:

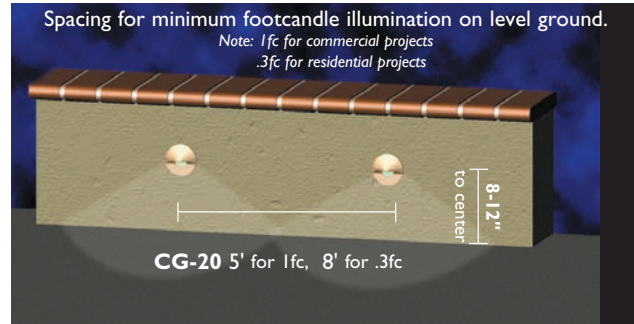

wall	φ
2'	
4'	
6'	
8'	
10'	
12'	

Footcandle Power

Distance from Center CG-20

2'	14
4'	2.5
6'	.93
8'	.53
10'	.38
12'	.10

For conversion to lumens: Multiply footcandles x 10. See FX glossary for a full description of fc and lumens.

WALL MOUNT INSTALL DETAIL:

INSTALL FX LUMINAIRE CUSTODE GRADINO AS SHOWN USING 16 GAUGE CABLE AND PROVIDED WIRE NUTS. PLASTIC 2" DIA. EMT TUBING CAN BE DRILLED FOR 1/2 CONDUIT TUBING USING A 7/8" HOLE SAW.

FX LUMINAIRE CUSTODE GRADINO FIXTURE INCORPORATES A REMOVABLE CAP FOR LAMP REPLACEMENT, AND SOLID BRASS BODY THAT SLIDES INSIDE A 2" DIA. PLASTIC EMT SLEEVE (NOT SUPPLIED WITH THIS PRODUCT) USED FOR PRE-INSTALLATION ALIGNMENT. THIS INSTALLATION MAKES ADJUSTMENTS TO THE WALL A PERFECT MATCH.

BLUE OR GRAY EMT CONDUIT WITH STRANDED THHN WIRE SIZED TO MATCH WATTAGE LOAD.

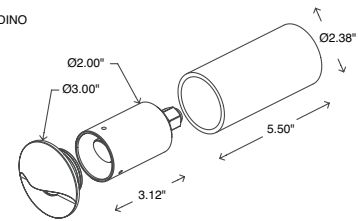

WATERPROOF SLEEVE END TO PREVENT WATER FROM SEEPING THROUGH THE WALL AND INTO THE LAMP HOUSING.

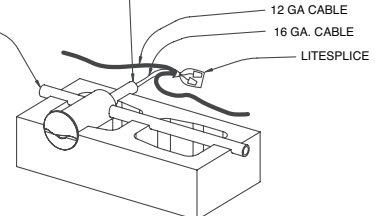

THIS FIXTURE IS DESIGNED FOR DOWN LIGHTING ONLY. DO NOT USE IN UP LIGHT POSITION

FX | LUMINAIRE®
MM-10

WALL
LIGHTING



MOLLUSCOMURO® | FX LUMINAIRE®

RUGGED, SMALL, AND
A CINCH TO INSTALL

When an integral mount is not practical specify the surface mounted MolluscoMuro®. To mount, the installer simply drills a 1/4" wire-way hole through the post or wall to connect fixture to mainline. Then with the provided screws, they attach the MM to the surface.

The patent pending MM fully exploits the micro scale of current 12v halogen lamp technology. The internal parabolic reflector maximizes lighting efficiency. Tempered glass diffuser optics softens the beam spread transition. The MM's narrow profile and wide range of powdercoat options allow it to blend into any surrounding.



REMODEL WITH EASE

The MM is a great choice for remodel projects where integral sleeving of wall lites is not feasible. A single 1/4" hole out the back (easy to waterseal) ties the MM to the 12 gauge mainline.

A great application for the MolluscoMuro® is to mount it to a deck railing post over a color pot. This brings the nighttime deck garden to life by accenting the color and throwing shadows on the deck surface.

STAIRWAY
LIGHTING

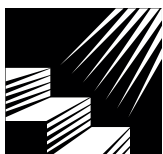

PERIMETER
LIGHTING

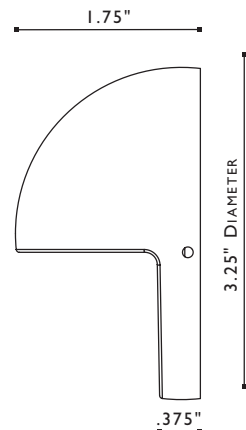
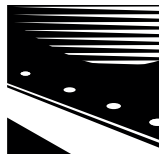

MOLLUSCO MURO® – ORDERING INFORMATION

The MM comes standard with a 10 watt Xenon G4 lamp and any finish.

STANDARD PARTS:



ORDERING SAMPLE:

SECTIONS:	DESCRIPTION:	WHAT TO ORDER:
1 + 2 + 3	+ +	= MM-10-BZ

STANDARD OPTIONS:

1 + 2 + 3 ORDERED TOGETHER ON SAME LINE

AVAILABLE LAMP CONFIGURATIONS:

Your choice of one lamp will come pre-installed.

FIXTURE/CODE	WATTAGE/CODE	AVG. LIFE HOUR
1 MM 	2 XENON LAMP OPTIONS:	
	10	10,000
	HALOGEN (H) LAMP OPTIONS:	
	10H	2000

FINISH OPTIONS:

Choose from the following options. All have regular lead times.

	CODE	DESCRIPTION
	3 BZ	Bronze Metallic
	DG	Desert Granite
	BF	Black Wrinkle
	VF	Verde Speckle
	SB	Sedona Brown
	WF	White Wrinkle
	WI	Weathered Iron

ADDITIONAL FINISH OPTION:

	CODE	DESCRIPTION
	BS	Brass <i>(will naturally patina)</i>
	NP	Nickel Plate

PHOTOMETRICS:

Spacing for minimum footcandle illumination on level ground.
.3fc for residential projects

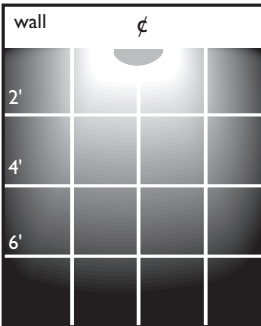

Footcandle Power

Distance from Center MM-10

1'	1.7
2'	.4
3'	.10

For conversion to lumens: Multiply footcandles x 10. See FX glossary for a full description of fc and lumens.

WALL MOUNT INSTALL DETAIL:

INSTALL FX LUMINAIRE MOLLUSCO MURO AS SHOWN USING 16 GAUGE CABLE AND PROVIDED WIRE NUTS.

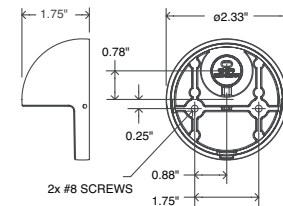

10 WATT MAXIMUM LAMP

WATERPROOF SLEEVE END TO PREVENT WATER FROM SEEPING THROUGH THE WALL AND INTO THE LAMP HOUSING.

BLUE OR GRAY ENT CONDUIT WITH STRANDED THHN WIRE SIZED TO MATCH WATTAGE LOAD.

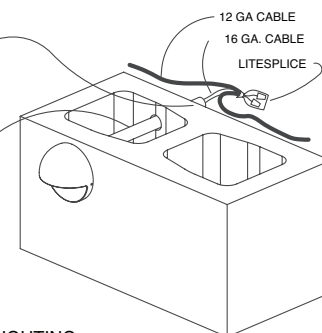

THIS FIXTURE IS DESIGNED FOR DOWN LIGHTING ONLY. DO NOT USE IN UP LIGHT POSITION

FX | LUMINAIRE®
MP-20



METALLOPESANTE® | FX LUMINAIRE®

SMALL PACKAGE,
TOUGH ATTITUDE

The MetalloPesante® (HeavyMetal) is constructed without compromise using aerospace grade alloys and silicone seals. This smaller version of our other uplites expands our line of luminaires, allowing the lighting designer to find an FX solution to most exterior lighting tasks.

This super small luminaire is an excellent choice for illuminating small garden elements such as shrubs, boulders and cactus.

The MP also has room for one lens insert. Choose from frosted for maximum diffusion or a color lens such as the peach or blue to shift color tones to enhance your desired effect.

Compare our uplites with any other and you will see whose quality of materials, precision of fit and consistency of finishing stands out above the rest.



THE FINEST MATERIALS

All FX Luminaire® diecast components are made in-house using the latest in computer assisted mold process control. We also use the very finest aerospace alloys to prevent premature product failure caused by corrosion.

All cast components are hand buffed before powdercoat to ensure a smooth lustrous finish. When your client's needs dictate the lowest maintenance, highest performance components, specify FX Luminaire®.

Note: This fixture is designed for uplighting only.

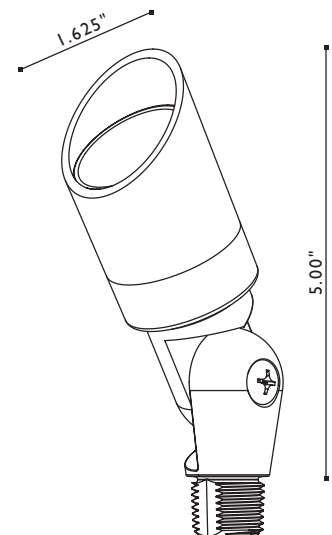

UPLIGHTING
SHRUBS

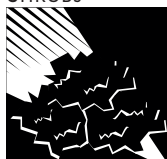

ARCHITECTURAL
ACCENTS



SHADOWING



EFFECTS



METALLOPESANTE® – ORDERING INFORMATION

MP comes standard with a 20 watt Halogen MR-11 FTD lamp, Clear Lens, Super Slot Spike®, and any finish.

STANDARD PARTS:



STANDARD OPTIONS:

1 + 2 + 3 ORDERED TOGETHER ON SAME LINE





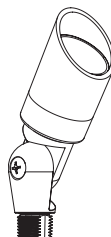

AVAILABLE LAMP CONFIGURATIONS:

Choose from any watt Halogen (H).

FIXTURE/CODE	WATTAGE/CODE	DESCRIPTION
1 MP	2 HALOGEN (H) LAMP OPTIONS:	
	20H	20 watt Halogen, wide 36° beam Avg. life 2000 hours

FINISH OPTIONS:

Choose from the following options. All have regular lead times.

	CODE	DESCRIPTION
	3 BZ	Bronze Metallic
	DG	Desert Granite
	BF	Black Wrinkle
	VF	Verde Speckle
	SB	Sedona Brown
	WF	White Wrinkle
	WI	Weathered Iron

ORDERING SAMPLE:

SECTIONS:	DESCRIPTION:	WHAT TO ORDER:
1 + 2 + 3	 + +	= MP-20-BZ
A, B and/or C	HexBaffle®	= HB
	CapannaDiNoce®	= CDS

NON-STANDARD OPTIONS:

A AND B, MUST BE ORDERED ON SEPARATE LINE!

ADDITIONAL GLARE CONTROL OPTIONS:

Does not come pre-assembled with glare control, they will arrive in separate box.

	CODE	DESCRIPTION
	A HB - MP	HexBaffle®

ADDITIONAL LENS OPTIONS:



Comes pre-assembled with a clear lens. All others will arrive in separate box.

	CODE	DESCRIPTION
	B FL-2	Frosted Lens
	CF-5	Peach Lens
	CF-6	Blue Lens

ADDITIONAL MOUNTING OPTIONS:

Comes pre-assembled with Super Slot Spike®.

All other mounting options will arrive in separate box.

	CODE	DESCRIPTION	SIZE
	C CDS	CapannaDiNoce®	2.00" x 10.00"
	SJ	SuperJ-boX®	2.50" x 12.00"
	PM	PostMount®	2.50" x 13.00"

FX | LUMINAIRE®
MU-20, MU-35, MU-50

UPLIGHTING &
 DOWNLIGHTING



**THE MOST VERSATILE
 LIGHT AVAILABLE**



The patent pending MacchiaUltimo® is one of the most versatile spotlights on the market and is the perfect choice for the discriminating landscape designer. The MU can be mounted as an uplight or downlight and is the new standard for advanced users.

It offers several different filter and accessory options that allow the designer to shape, color shift, and control light output. A wide variety of effects can be produced by adding our patented RecessorRing®, HexBaffle® or one of our many filters, spread lens or glare control options.

This spotlight is engineered for the lighting designer who takes a "hands-on" approach to each project!

For more information, contact the factory and request the "MU catalog."

MACCHIAULTIMO® | FX LUMINAIRE®



MU STACK OPTIONS

Stack A: Ground Mounted
 Configuration:
 No Filters / No RecessorRings®

Stack B: Ground Mounted
 Configuration:
 1-2 Filters / No RecessorRings®

Stack C: Ground Mounted
 Configuration:
 HexBaffle®, 1 Filter / 1 or 2 RecessorRings®

Stack D: Ground Mounted
 Configuration:
 No Filters / 1 or 2 RecessorRings®

Stack D: Downlight Mounted
 Configuration:
 No Filters / 1 or 2 RecessorRings®

Stack E: Ground Mounted
 Configuration:
 RecessorRing® / Filter(s) / RecessorRing®

Stack F: Ground Mounted
 Configuration:
 RecessorRing®(s) / Filter(s)

Stack F: Downlight Mounted
 Configuration:
 RecessorRing®(s) / Filter(s)

Stack G: Ground Mounted
 Configuration:
 RecessorRing® / Filter / RecessorRing® / Filter

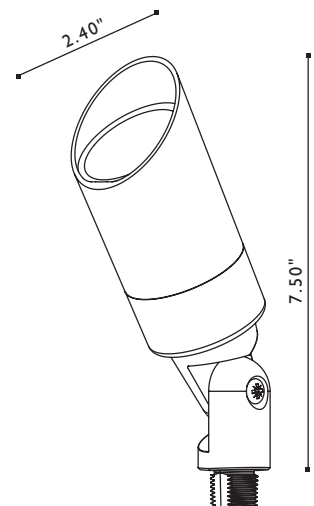

UPLIGHTING
 TREES



DOWNLIGHTING
 TREES & EAVES



ARCHITECTURAL
 ACCENTS



SHADOWING



EFFECTS



MACCHIAULTIMO® – ORDERING INFORMATION

MU comes standard with a 20 watt Halogen MR-16 lamp, Clear Lens, Super Slot Spike®, and any finish.

STANDARD PARTS:



STANDARD OPTIONS:

1 + 2 + 3 ORDERED TOGETHER ON SAME LINE

STANDARD LAMP CONFIGURATIONS:

Choose from any watt Halogen (H).

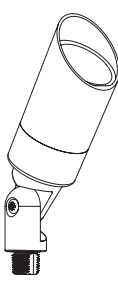
FIXTURE/CODE	WATTAGE/CODE	AVG. LIFE HOUR
1 MU 	2 HALOGEN (H) LAMP OPTIONS:	
	20H	20 watt Halogen, wide, 36° beam, Avg. life 5000 hours; now available in 10000 hours (new)
	20V-H	20 watt Halogen, very narrow, 10° beam, Avg. life 5000 hours
	35H	35 watt Halogen, wide, 36° beam, Avg. life 5000 hours; now available in 10000 hours (new)
	35V-H	35 watt Halogen, very narrow, 10° beam, Avg. life 5000 hours
	50H	50 watt Halogen, wide, 40° beam, Avg. life 5000 hours; now available in 10000 hours (new)
	50N-H	50 watt Halogen, narrow, 36° beam, Avg. life 5000 hours;
	50V-H	50 watt Halogen, very narrow, 10° beam, Avg. life 5000 hours

LAMP NOTE:

Some lamps are by special order. Please check with our factory for availability.

FINISH OPTIONS:

Choose from the following options. All have regular lead times.

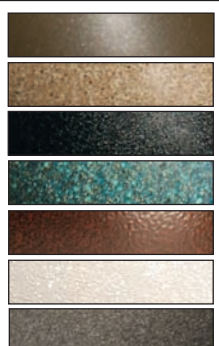
CODE	DESCRIPTION
3 	BZ Bronze Metallic
	DG Desert Granite
	BF Black Wrinkle
	VF Verde Speckle
	SB Sedona Brown
	WF White Wrinkle
	WI Weathered Iron

ORDERING SAMPLE:

SECTIONS:	DESCRIPTION:	WHAT TO ORDER:
1 + 2 + 3	 +	= MU-50-BZ
A, B and/or C	HexBaffle®	= HB
	CapannaDiNoce®	= CDS

NON-STANDARD OPTIONS:

A, B AND C, MUST BE ORDERED ON SEPARATE LINE!

ADDITIONAL GLARE CONTROL OPTIONS:

Does not come pre-assembled with glare control, they will arrive in separate box.

CODE	DESCRIPTION
 A	HB HexBaffle®
	RR RecessorRing®

ADDITIONAL LENS OPTIONS:

Comes pre-assembled with a clear lens. All others will arrive in separate box.

CODE	DESCRIPTION
 B	F Frosted Lens
	S Spread Lens
	SO Solite Lens
	CF-1 Peach Lens
	CF-2 Blue Lens
	CF-3 Green Lens
	CF-4 Red Lens

ADDITIONAL MOUNTING OPTIONS:

Comes pre-assembled with Super Slot Spike®.

All other mounting options will arrive in separate box.

CODE	DESCRIPTION	SIZE
 C	CDS CapannaDiNoce®	2.00" x 10.00"
	SJ SuperJ-boX®	2.50" x 12.00"
	PM PostMount®	2.50" x 13.00"
	MJ-RS Mini J-Box®	3.50" x 2.125" x 1.320"
	VB VersaBoX®	2.50" x 2.00"

FX | LUMINAIRE®
CM-10, CM-20

UPLIGHTING



FOR SMALL SCALE
GARDEN ELEMENTS

Use this warm, xenon lamp source to enhance earth tones or create an intimate atmosphere.

This precision lighting instrument is a fine example of engineering for simplicity and reliability. Through the innovative use of an O-ring hydraulic compression cap seal, the potentially troublesome threads and screws found in other spotlights are eliminated.

The patent pending CaloreMasso® is constructed without compromise using aerospace grade alloys and silicone seals.

We have engineered a white reflector to soften the lamp's output, thereby allowing the designer to get the benefits of the small, low voltage components, without overpowering the space with light.

CALOREMASSO® | FX LUMINAIRE®



FX FAMILY OF UPLIGHTS:

When your client's needs dictate the lowest maintenance, highest performance components, specify FX Luminaire® uplites. These rugged and innovative luminaires are made of the very finest aerospace alloys to prevent premature product failure caused by corrosion. All cast components are hand polished before powdercoat to ensure a smooth lustrous finish. Every FX Luminaire® diecast component is made in-house using the latest in computer assisted mold process control.

Note: This fixture is designed for uplighting only.

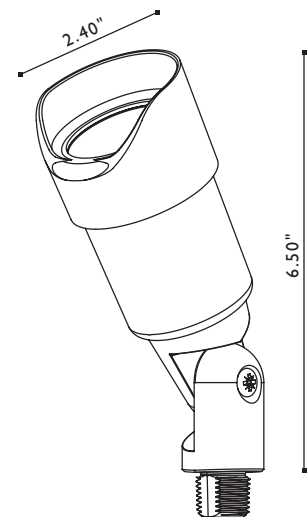

UPLIGHTING
SHRUBS



ARCHITECTURAL
ACCENTS



SHADOWING



EFFECTS



WALL
WASHING



CALOREMASSO® – ORDERING INFORMATION

CM comes standard with a 20 watt Xenon G4 lamp, Clear or Frosted Lens (specify F after wattage, EX: CM-20-F-BZ), Super Slot Spike®, and any finish.

STANDARD PARTS:

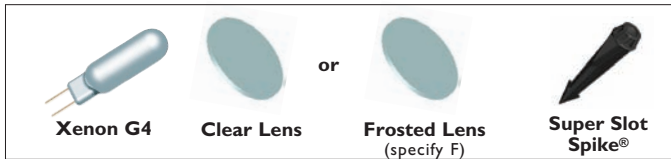

STANDARD OPTIONS:

1 + 2 + 3 ORDERED TOGETHER ON SAME LINE

AVAILABLE LAMP CONFIGURATIONS:

Your choice of one lamp will come pre-installed.

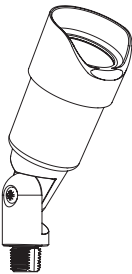

FIXTURE/CODE	WATTAGE/CODE	AVG. LIFE HOUR
1 CM 	2 XENON LAMP OPTIONS:	
	10	10,000
	20	5000

FINISH OPTIONS:

Choose from the following options. All have regular lead times.

CODE	DESCRIPTION
3 BZ	Bronze Metallic
DG	Desert Granite
BF	Black Wrinkle
VF	Verde Speckle
SB	Sedona Brown
WF	White Wrinkle
WI	Weathered Iron

ORDERING SAMPLE:

SECTIONS:	DESCRIPTION:	WHAT TO ORDER:
1 + 2 + 3	 +  + 	= CM-20-BZ
A, B and/or C	HexBaffle®	= HB
	CapannaDiNoce®	= CDS

NON-STANDARD OPTIONS:

A, B AND C MUST BE ORDERED ON SEPARATE LINE!

ADDITIONAL GLARE CONTROL OPTIONS:

Does not come pre-assembled with glare control, they will arrive in separate box.

CODE	DESCRIPTION
A HB	HexBaffle®

ADDITIONAL LENS OPTIONS:

Comes pre-assembled with a clear lens. All others will arrive in separate box.

CODE	DESCRIPTION
B S	Spread Lens
SO	Solite Lens
CF-1	Peach Lens
CF-2	Blue Lens
CF-3	Green Lens
CF-4	Red Lens

ADDITIONAL MOUNTING OPTIONS:

Comes pre-assembled with Super Slot Spike®.

All other mounting options will arrive in separate box.

CODE	DESCRIPTION	SIZE
C CDS	CapannaDiNoce®	2.00" x 10.00"
SJ	SuperJ-boX®	2.50" x 12.00"
PM	PostMount®	2.50" x 13.00"

FX | LUMINAIRE®
RS-20, RS-35

UPLIGHTING

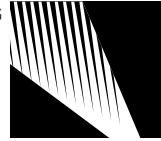

REFLECTORESTELLATO® | FX LUMINAIRE®

MULTIPLE LIGHTING
POSSIBILITIES

The ReflectoreStellato® is a rugged micro luminaire that provides the power and control of the halogen MR-16 lamp family. This patent pending, precision lighting instrument is a fine example of engineering for simplicity and reliability. Through the use of an O-ring hydraulic compression cap seal, the potentially troublesome threads and screws found in other spotlights are eliminated.

The ReflectoreStellato® is constructed without compromise using aerospace grade alloys and silicone seals. Because of its high efficiency, beam control, color rendition and availability, the MR-16 lamp family was chosen to power this luminaire.

With this broad range of illuminating possibilities the lighting designer can find an FX solution to most exterior lighting tasks.

Note: This fixture is designed for uplighting only.

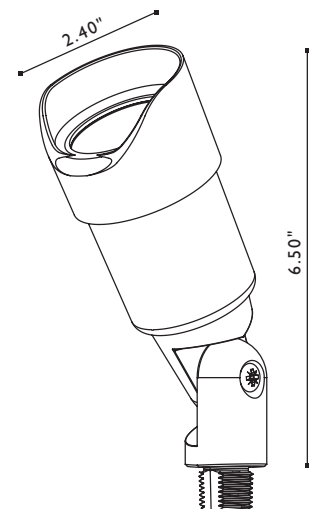

UPLIGHTING
TREES



ARCHITECTURAL
ACCENTS



ENTRY
MONUMENTS



REFLECTORSTELLATO® – ORDERING INFORMATION

RS comes standard with a 20 watt MR-16 Halogen lamp, Clear or Frosted Lens (specify F after wattage, EX: RS-20-F-BZ.), Super Slot Spike®, and any finish.

STANDARD PARTS:

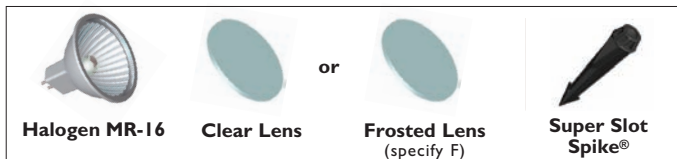

STANDARD OPTIONS:

1 + 2 + 3 ORDERED TOGETHER ON SAME LINE

STANDARD LAMP CONFIGURATIONS:

Choose from any watt Halogen (H).

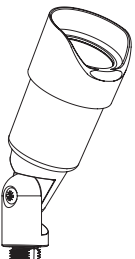
FIXTURE/CODE	WATTAGE/CODE	AVG. LIFE HOUR
	2 HALOGEN (H) LAMP OPTIONS:	
	20H	20 watt Halogen, wide, 36° beam, Avg. life 5000 hours; now available in 10000 hours <i>(new)</i>
	20V-H	20 watt Halogen, very narrow, 10° beam, Avg. life 4000 hours
	35H	35 watt Halogen, wide, 36° beam, Avg. life 5000 hours; now available in 10000 hours <i>(new)</i>
	35V-H	35 watt Halogen, very narrow, 10° beam, Avg. life 5000 hours

LAMP NOTE:

Some lamps are by special order. Please check with our factory for availability.

FINISH OPTIONS:

Allow extra time for the following finish options:

	3 BZ	Bronze Metallic
	DG	Desert Granite
	BF	Black Wrinkle
	VF	Verde Speckle
	SB	Sedona Brown
	WF	White Wrinkle
	WI	Weathered Iron

ORDERING SAMPLE:

SECTIONS:	DESCRIPTION:	WHAT TO ORDER:
1 + 2 + 3		= RS-20-BZ
A, B and/or C	HexBaffle®	= HB
	CapannaDiNoce®	= CDS

NON-STANDARD OPTIONS:

A, B AND C MUST BE ORDERED ON SEPARATE LINE!

ADDITIONAL GLARE CONTROL OPTIONS:

Does not come pre-assembled with glare control, they will arrive in separate box.

CODE	DESCRIPTION
A	HB HexBaffle®

ADDITIONAL LENS OPTIONS:

Comes pre-assembled with a clear lens. All others will arrive in separate box.

CODE	DESCRIPTION
B	S Spread Lens
	SO Solite Lens
	CF-1 Peach Lens
	CF-2 Blue Lens
	CF-3 Green Lens
	CF-4 Red Lens

ADDITIONAL MOUNTING OPTIONS:

Comes pre-assembled with Super Slot Spike®.

All other mounting options will arrive in separate box.

CODE	DESCRIPTION	SIZE
C	CDS CapannaDiNoce®	2.00" x 10.00"
	SJ SuperJ-boX®	2.50" x 12.00"
	PM PostMount®	2.50" x 13.00"

FX | LUMINAIRE®
SI-5, SI-10, SI-20, SI-35



SOFT DIFFUSE
HALOGEN ILLUMINATION

The SpuntareIntimo® fills the niche of the occasional need for a more subtle light source.

We have engineered a white reflector to soften the lamp's output thereby allowing the designer to get the benefits of halogen long life without overpowering the space with light. The bi-pin lamp in the SpuntareIntimo® provides an even neutral color rendition.

This patent pending luminaire is an excellent choice for subtly illuminating small elements in residential courtyards or intimate seating areas. It is also a great light source for shadowing or backlighting small plant material.

When used with the clear lens positioned 8-12" from a stucco wall the SI will produce its signature elliptical scallop light pattern. This elegant technique is effective even if no plant material is in the foreground because it breaks up the static linear lines of an otherwise plain straight wall.



SIT BACK AND ENJOY

Your pleasure of outdoor living does not have to end when the sun goes down. If you want to spend time outdoors after dark just add some elegant landscape lighting. Whether you want to just relax, have a meal, or entertain, landscape lighting can help. You have invested money on that nice grill, weather-proofed furniture, and gas heaters, however your time to enjoy them doesn't have to be limited to day-light hours. Once you add lighting outdoors, it will be hard to imagine all that time you wasted indoors!

Note: This fixture is designed for uplighting only.

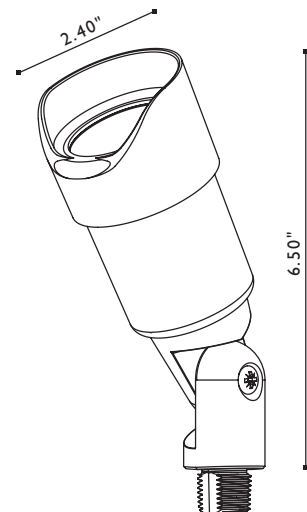

UPLIGHTING SHRUBS



ARCHITECTURAL ACCENTS



SHADOWING



EFFECTS



WALL WASHING



SPUNTAREINTIMO® – ORDERING INFORMATION

SI comes standard with a 20 watt T3 Halogen lamp, Clear or Frosted Lens (specify F after wattage, EX: SI-20H-F-BZ.), Super Slot Spike®, and any finish.

STANDARD PARTS:

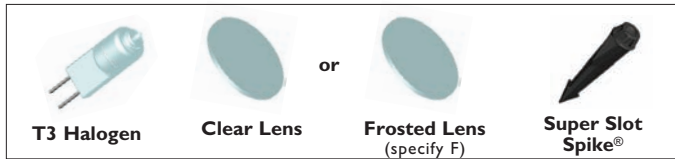

STANDARD OPTIONS:

1 + 2 + 3 ORDERED TOGETHER ON SAME LINE

AVAILABLE LAMP CONFIGURATIONS:

Your choice of one lamp will come pre-installed.

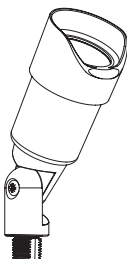
FIXTURE/CODE	WATTAGE/CODE	AVG. LIFE HOUR
1 SI 	2 HALOGEN (H) LAMP OPTIONS:	
	5H	2000
	10H	2000
	20H	2000
	35H	2000

FINISH OPTIONS:

Choose from the following options. All have regular lead times.

CODE	DESCRIPTION
3 BZ	Bronze Metallic
DG	Desert Granite
BF	Black Wrinkle
VF	Verde Speckle
SB	Sedona Brown
WF	White Wrinkle
WI	Weathered Iron

ORDERING SAMPLE:

SECTIONS:	DESCRIPTION:	WHAT TO ORDER:
1 + 2 + 3		= SI-20H-BZ
A, B and/or C	HexBaffle®	= HB
	CapannaDiNoce®	= CDS

NON-STANDARD OPTIONS:

A, B AND C MUST BE ORDERED ON SEPARATE LINE!

ADDITIONAL GLARE CONTROL OPTIONS:

Does not come pre-assembled with glare control, they will arrive in separate box.

CODE	DESCRIPTION
A HB	HexBaffle®

ADDITIONAL LENS OPTIONS:

Comes pre-assembled with a clear lens. All others will arrive in separate box.

CODE	DESCRIPTION
B S	Spread Lens
SO	Solite Lens
CF-1	Peach Lens
CF-2	Blue Lens
CF-3	Green Lens
CF-4	Red Lens

ADDITIONAL MOUNTING OPTIONS:

Comes pre-assembled with Super Slot Spike®.

All other mounting options will arrive in separate box.

CODE	DESCRIPTION	SIZE
C CDS	CapannaDiNoce®	2.00" x 10.00"
SJ	SuperJ-boX®	2.50" x 12.00"
PM	PostMount®	2.50" x 13.00"

FX | LUMINAIRE®
CR-10, CR-20



THE FINEST SMALL
SCALE UPLIGHT

The FX Luminaire® CarinoRame® fills the niche of the occasional need for a more subtle light source.

We have engineered a white reflector to soften the lamp's output, thereby allowing the designer to get the benefits of halogen long life without overpowering the space with light. Whereas the MR-16 lamp RS series produces a crisp light that has a distinct center beam, the bi-pin lamp in the CarinoRame® provides a mellow even neutral light output.

This patent pending luminaire is an excellent choice for shadowing or backlighting small plant material. When used with the clear lens positioned 8-12" from a stucco wall the CR will produce its signature elliptical scallop light pattern. This elegant technique is effective even if no plant material is in the foreground because it breaks up the static linear lines of an otherwise plain straight wall.

CARINORAME® | FX LUMINAIRE®



LONG-TERM CONTRIBUTION
Milled from solid copper and brass the CR is engineered to make a long term contribution to any fine project. Specify on winery chateaux, resorts or residential projects where the owner values products that are built for the ages.

Compare FX copper luminaires with any other, and you will find a dramatic difference in quality of materials, precision of fit and consistency of finish.

Note: This fixture is designed for uplighting only.

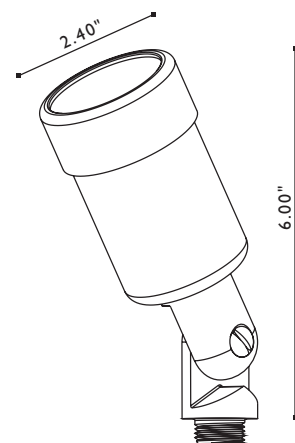

UPLIGHTING
SHRUBS



ARCHITECTURAL
ACCENTS



SHADOWING



EFFECTS



WALL
WASHING



CARINORAME® – ORDERING INFORMATION

The CR comes standard with a 20 watt Xenon G4 lamp, Clear Lens, Super Slot Spike®, and in Copper (CU).

STANDARD PARTS:

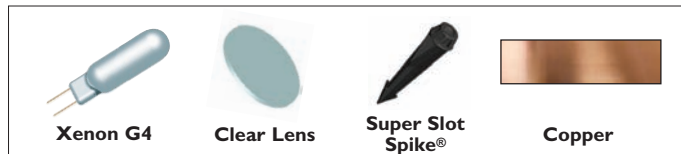

STANDARD OPTIONS:

1 + 2 + 3 ORDERED TOGETHER ON SAME LINE

AVAILABLE LAMP CONFIGURATIONS:

Your choice of one lamp will come pre-installed.

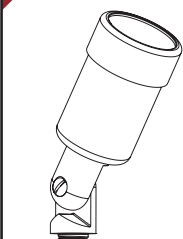
FIXTURE/CODE	WATTAGE/CODE	AVG. LIFE HOUR
1 CR 	2 XENON LAMP OPTIONS:	
	10	10,000
	20	5000
	HALOGEN (H) LAMP OPTIONS:	
	10H	2000
	20H	2000

STANDARD FINISH OPTIONS:

Copper is standard. All other choices must be specified.

CODE	DESCRIPTION
CU	Copper <i>(will naturally patina)</i>

NON-STOCKING FINISH OPTIONS:

Allow extra time for the following finish options:

	3 NP	Nickel Plate
-------------------------------------------------------------------------------------	-------------	--------------

ORDERING SAMPLE:

SECTIONS:	DESCRIPTION:	WHAT TO ORDER:
1 + 2 + 3 <small>optional</small>	 +  + 	= CR-20
A, B and/or C	Glare Shield	= GS
	PostMount®	= PM

NON-STANDARD OPTIONS:

A, B AND C, MUST BE ORDERED ON SEPARATE LINE!

ADDITIONAL GLARE CONTROL OPTIONS:

Does not come pre-assembled with glare control.

CODE	DESCRIPTION	
	A GS	Glare Shield
	HB	HexBaffle®

ADDITIONAL LENS OPTIONS:

Comes pre-assembled with a clear lens. All others will arrive in separate box.

CODE	DESCRIPTION	
	B F	Frosted Lens
	S	Spread Lens
	SO	Solite Lens
	CF-1	Peach Lens
	CF-2	Blue Lens
	CF-3	Green Lens
CF-4	Red Lens	

ADDITIONAL MOUNTING OPTIONS:

Comes pre-assembled with Super Slot Spike®.

All other mounting options will arrive in separate box.

CODE	DESCRIPTION	SIZE
	C CDS	CapannaDiNoce® 2.00" x 10.00"
	SJ	SuperJ-boX® 2.50" x 12.00"
	PM	PostMount® 2.50" x 13.00"

FX | LUMINAIRE®
LR-20, LR-35, LR-50



THE FINEST UPLIGHT
YOU CAN SPECIFY

Engineered for the client that wants to make a long-term investment in their garden, the Lustrorame® is without peer. This patent pending rugged micro luminaire provides the power and control of the halogen MR-16 lamp family. Through the innovative use of an O-ring hydraulic compression cap seal, the potentially troublesome threads and screws found in other spotlights are eliminated.

The Lustrorame® is constructed without any compromise using 100% non-ferrous alloys and silicone seals. The Lustrorame® accommodates 28 different lamps ranging from 10-50 watts with a variety of beam spreads.

The copper will patina naturally over time and can be accelerated with solution spray. For patina formulas visit our website at: www.FXL.com/learning/patina.htm



INNOVATIVE SOLUTIONS

Any spotlight's durability and reliability can be determined by the integrity of two key components. First are the moisture seals— if water penetrates the fixture housing socket then lamp failure will occur. Second is the long term integrity of the knuckle joint. The LR's innovative solution solves both challenges and provides your clients trouble-free ownership.

Compare FX copper luminaires with any other, and you will find a dramatic difference in quality of materials, precision of fit and consistency of finish.

Note: This fixture is designed for uplighting only.

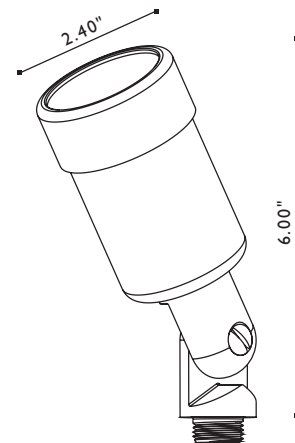

UPLIGHTING
TREES



ARCHITECTURAL
ACCENTS



ENTRY
MONUMENTS



LUSTROAME® - ORDERING INFORMATION

The LR comes standard with a 20 watt Halogen MR-16 lamp, Clear Lens, Super Slot Spike®, and in Copper (CU).

STANDARD PARTS:

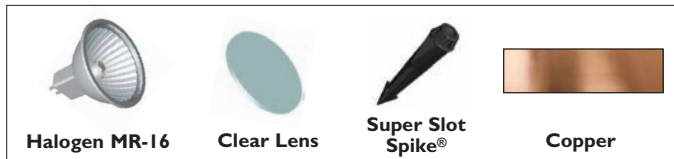

STANDARD OPTIONS:

I + 2 + 3 ORDERED TOGETHER ON SAME LINE

STANDARD LAMP CONFIGURATIONS:

Choose from any watt Halogen (H).

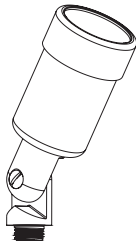
FIXTURE/CODE	WATTAGE/CODE	DESCRIPTION
1 LR 	2 HALOGEN (H) LAMP OPTIONS:	
	20H	20 watt Halogen, wide, 36° beam, Avg. life 5000 hours; now available in 10000 hours (new)
	20V-H	20 watt Halogen, very narrow, 10° beam, Avg. life 5000 hours
	35H	35 watt Halogen, wide, 36° beam, Avg. life 5000 hours; now available in 10000 hours (new)
	35V-H	35 watt Halogen, very narrow, 10° beam, Avg. life 5000 hours
	50H	50 watt Halogen, wide, 36° beam, Avg. life 5000 hours; now available in 10000 hours (new)
	50N-H	50 watt Halogen, narrow, 25° beam, Avg. life 5000 hours;
	50V-H	50 watt Halogen, very narrow, 10° beam, Avg. life 5000 hours

LAMP NOTE:

Some lamps are by special order. Please check with our factory for availability.

STANDARD FINISH OPTIONS:

Copper is standard. All other choices must be specified.

CODE	DESCRIPTION
CU	Copper (will naturally patina)

NON-STOCKING FINISH OPTIONS:

Allow extra time for the following finish options:

CODE	DESCRIPTION
3 NP	Nickel Plate

ORDERING SAMPLE:

SECTIONS:	DESCRIPTION:	WHAT TO ORDER:
I + 2 + 3 <small>optional</small>	 +  + 	= LR-20
A, B and/or C	Glare Shield	= GS
	PostMount	= PM

NON-STANDARD OPTIONS:

A, B AND C, MUST BE ORDERED ON SEPARATE LINE!

ADDITIONAL GLARE CONTROL OPTIONS:

Does not come pre-assembled with glare control.

CODE	DESCRIPTION
A GS	Glare Shield
HB	HexBaffle®

ADDITIONAL LENS OPTIONS:

Comes pre-assembled with a clear lens. All others will arrive in separate box.

CODE	DESCRIPTION
B F	Frosted Lens
S	Spread Lens
SO	Solite Lens
CF-1	Peach Lens
CF-2	Blue Lens
CF-3	Green Lens
CF-4	Red Lens

ADDITIONAL MOUNTING OPTIONS:

Comes pre-assembled with Super Slot Spike®.

All other mounting options will arrive in separate box.

CODE	DESCRIPTION	SIZE
C CDS	CapannaDiNoce®	2.00" x 10.00"
SJ	SuperJ-boX®	2.50" x 12.00"
PM	PostMount®	2.50" x 13.00"

FX | LUMINAIRE®
 LO-20, LO-35, LO-50



LAMPADA OTTONE® | FX LUMINAIRE®

FINE SOLID BRASS
 CONSTRUCTION

Our premiere uplight luminaire is built to last a lifetime but priced for the value-conscious project owner. Milled from solid billet brass, this is the best choice for applications such as island resorts or beachside homes that demand extreme durability and high performance. A wide range of filters and glare control devices allows the lighting designer to shape the beam for precise light painting of any fine exterior.

FX has taken the semi-precious metal brass and created a clean distinctive form that incorporates exclusive beam control and light shaping options. Silicone O-ring seals create a watertight enclosure allowing the designer to use the LO as an uplight or downlight.

The patent pending LO will accommodate 28 different lamps ranging from 20-50 watts with a variety of beam spreads.



YEARS OF STRENGTH

Brass has been the material of choice for nautical hardware metal smiths for centuries. Olde World craftsmen appreciated the unique qualities of brass such as the ability to incorporate fine mechanical detail, its resistance to corrosion, even in the most hostile environments, and the ease with which brass can be restored to a high polish if desired.

The brass will patina naturally over time and can be accelerated with solution spray. For patina formulas visit www.FXL.com/patina.

Note: This fixture is designed for uplighting only.

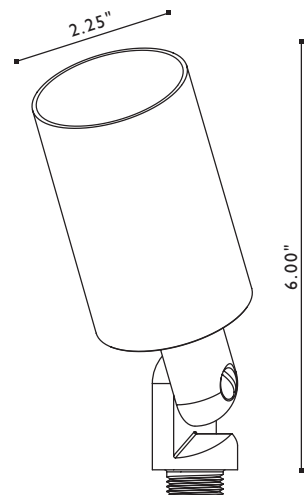

UPLIGHTING
 TREES



ARCHITECTURAL
 ACCENTS



ENTRY
 MONUMENTS



LAMPADOTTONE® – ORDERING INFORMATION

The LO comes standard with a 20 watt Halogen MR-16 lamp, Clear Lens, Super Slot Spike®, and in Brass (BS).

STANDARD PARTS:

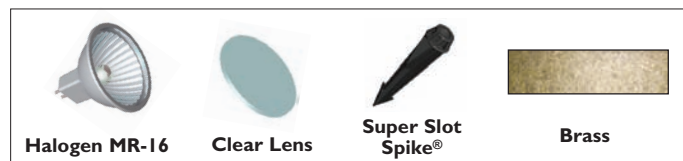

STANDARD OPTIONS:

I + 2 + 3 ORDERED TOGETHER ON SAME LINE

STANDARD LAMP CONFIGURATIONS:

Choose from any watt Halogen (H).

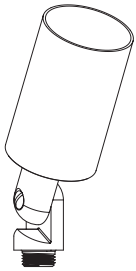
FIXTURE/CODE	WATTAGE/CODE	DESCRIPTION
1 LO 	2 HALOGEN (H) LAMP OPTIONS:	
	20H	20 watt Halogen, wide, 36° beam, Avg. life 5000 hours; now available in 10000 hours (new)
	20V-H	20 watt Halogen, very narrow, 10° beam, Avg. life 5000 hours
	35H	35 watt Halogen, wide, 36° beam, Avg. life 5000 hours; now available in 10000 hours (new)
	35V-H	35 watt Halogen, very narrow, 10° beam, Avg. life 5000 hours
	50H	50 watt Halogen, wide, 36° beam, Avg. life 5000 hours; now available in 10000 hours (new)
	50N-H	50 watt Halogen, narrow, 25° beam, Avg. life 5000 hours; now available in 10000 hours (new)
	50V-H	50 watt Halogen, very narrow, 10° beam, Avg. life 5000 hours

LAMP NOTE:

Some lamps are by special order. Please check with our factory for availability.

STANDARD FINISH OPTIONS:

Brass is standard. All other choices must be specified.

CODE	DESCRIPTION
BS	Brass (will naturally patina)

NON-STOCKING FINISH OPTIONS:

Allow extra time for the following finish options:

	3 NP Nickel Plate
-------------------------------------------------------------------------------------	-----------------------------

ORDERING SAMPLE:

SECTIONS:	DESCRIPTION:	WHAT TO ORDER:
I + 2 + 3 <small>optional</small>		= LO-50
A, B and/or C	HexBaffle®	= HB
	PostMount®	= PM

NON-STANDARD OPTIONS:

A, B AND C, MUST BE ORDERED ON SEPARATE LINE!

ADDITIONAL GLARE CONTROL OPTIONS:

Does not come pre-assembled with glare control, they will arrive in separate box.

CODE	DESCRIPTION
 A HB	HexBaffle®

ADDITIONAL LENS OPTIONS:



Comes pre-assembled with a clear lens. All others will arrive in separate box.

CODE	DESCRIPTION
 B	F Frosted Lens S Spread Lens SO Solite Lens CF-1 Peach Lens CF-2 Blue Lens CF-3 Green Lens CF-4 Red Lens

ADDITIONAL MOUNTING OPTIONS:

Comes pre-assembled with Super Slot Spike®.

All other mounting options will arrive in separate box.

CODE	DESCRIPTION	SIZE
 C CDS	CapannaDiNoce®	2.00" x 10.00"
 SJ	SuperJ-boX®	2.50" x 12.00"
 PM	PostMount®	2.50" x 13.00"

FX | LUMINAIRE®
RL-10, RL-20

UPLIGHTING

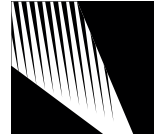

SOFT LIGHT,
STRONG LUMINAIRE

When trying to create a super soft washlight there are very few well engineered products for today's lighting designer. The patent pending RotondoLuna® is specifically designed to gently illuminate small scale plant material, boulders, and short garden walls. Halogen lamp model produces a high-efficiency white light. The xenon lamp has a mellow golden light output for enriching earth tone elements.

At FX, we engineer fixtures from the inside out. Our use of semi precious metals, aerospace sealants and materials is without peer. This commitment to excellence provides your client with decades of problem-free ownership.

Compare FX copper luminaires with any other, and you will find a dramatic difference in quality of materials, precision of fit and consistency of finish.

ROTONDOLUNA® | FX LUMINAIRE®



LIGHTING EFFECTS
WITH THE RL

To wall wash with the RL, the fixtures should be installed 12-18" from the base of the wall, 6-8' on center thereby creating an even illumination. This technique is very efficient because it highlights the wall and then reflects a soft, glare-free ambient glow onto the surrounding area. When spotlights are placed behind plant material or a garden element and aimed at an adjacent wall to create a backdrop, it allows the viewer to enjoy the silhouette form of the object only. This technique is useful when trying to showcase very dense plant material that has interesting structure.

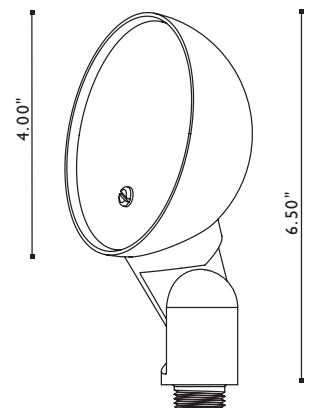

Note: This fixture is designed for uplighting only.

SHADOWING

EFFECTS

WALL
WASHING



ROTONDO LUNA® – ORDERING INFORMATION

RL comes standard with a 20 watt Xenon G4 lamp, Super Slot Spike®, and in Copper (CU).

STANDARD PARTS:



STANDARD OPTIONS:

1 + 2 + 3 ORDERED TOGETHER ON SAME LINE

AVAILABLE LAMP CONFIGURATIONS:

Your choice of one lamp will come pre-installed.

FIXTURE/CODE	WATTAGE/CODE	AVG. LIFE HOUR
1 RL 	2 XENON LAMP OPTIONS:	
	10	10,000
	20	5000
	HALOGEN (H) LAMP OPTIONS:	
	10H	2000
	20H	2000
	35H	2000







STANDARD FINISH OPTIONS:

Copper is standard. All other choices must be specified.

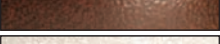

CODE	DESCRIPTION
CU	Copper <i>(will naturally patina)</i>

NON-STOCKING FINISH OPTIONS:

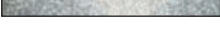
Allow extra time for the following finish options:

	3 BZ	Bronze Metallic
	DG	Desert Granite
	BF	Black Wrinkle
	VF	Verde Speckle
	SB	Sedona Brown
	WF	White Wrinkle
	WI	Weathered Iron
	NP	Nickel Plate

ORDERING SAMPLE:

SECTIONS:	DESCRIPTION:	WHAT TO ORDER:
1 + 2 + 3 <small>optional</small>	 +  + 	= RL-20
A	CapannaDiNoce®	= CDS

NON-STANDARD OPTIONS:

MUST BE ORDERED ON SEPARATE LINE!

ADDITIONAL MOUNTING OPTIONS:

Comes pre-assembled with Super Slot Spike®.

All other mounting options will arrive in separate box.

CODE	DESCRIPTION	SIZE
A CDS	CapannaDiNoce®	2.00" x 10.00"
SJ	SuperJ-boX®	2.50" x 12.00"
PM	PostMount®	2.50" x 13.00"

FX | LUMINAIRE®
LS-12



LUNASONORA® | FX LUMINAIRE®

DOWNLIGHTING



FOR VERY SMALL SCALE
DOWNLIGHTING

When a moonlighting effect is desired, but the caliper of a tree is too small, specify the FX Luminaire® LunaSonora®. This micro downlight actually hangs from the host tree by a cinch tie requiring no screws or permanent hardware. Use two or more fixtures for an even illumination.

A small brass hook is included for beam mounted applications. Milled from heavy copper and solid brass hardware, this luminaire incorporates a frosted glass lamp to soften beam spread edge. The LS can be hung 24" off ground level without overpowering the garden space below.

For larger scale plant material that requires a higher mounting height, specify the halogen ViteLume®.



MULTIPLE EFFECTS

Small scale plant material that is in focal planter areas can become the host for a micro-moon lighting effect. When combined with SpuntareIntimo uplites the LS creates a "reflected light" effect.

Compare FX copper luminaires with any other, and you will find a dramatic difference. We use the heaviest gauge materials in the industry for long-lasting performance.

The copper will patina naturally over time and can be accelerated with solution spray. For patina formulas visit our website at: Ohwww.FXL.com/patina.

Note: This fixture is designed for downlighting only.

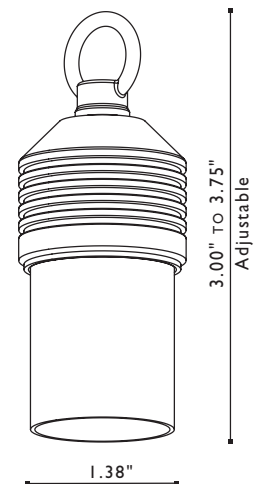

DOWNLIGHTING
TREES & EAVES



LUNASONORA® – ORDERING INFORMATION

The LS comes standard with 12 watt Frosted Incandescent lamp and in Copper (CU).

STANDARD PARTS:

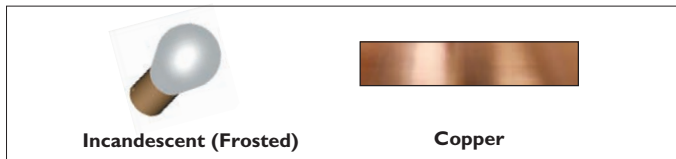

ORDERING SAMPLE:

SECTIONS:	DESCRIPTION:	WHAT TO ORDER:
1 + 2 + 3 <small>optional</small>	+ +	= LS-12

STANDARD OPTIONS:

1 + 2 + 3 ORDERED TOGETHER ON SAME LINE

AVAILABLE LAMP CONFIGURATIONS:

Your choice of one lamp will come pre-installed.

FIXTURE/CODE	WATTAGE/CODE	AVG.LIFE HOUR
1 LS	2 INCANDESCENT LAMP OPTIONS:	
	12	2000

STANDARD FINISH OPTIONS:

Copper is standard. All other choices must be specified.

CODE	DESCRIPTION
CU	Copper <i>(will naturally patina)</i>

NON-STOCKING FINISH OPTIONS:

Allow extra time for the following finish options:

3 NP	Nickel Plate
--------------------	--------------

TREE BRANCH INSTALL DETAIL:

FX LUMINAIRE LUNA SONORA. HANG WITH PROVIDED CABLE TIE.
CINCH CABLE TIE SO IT IS LOOSE TO ALLOW TREE GROWTH.
REPLACE CABLE TIE EACH TIME LAMP IS REPLACED.

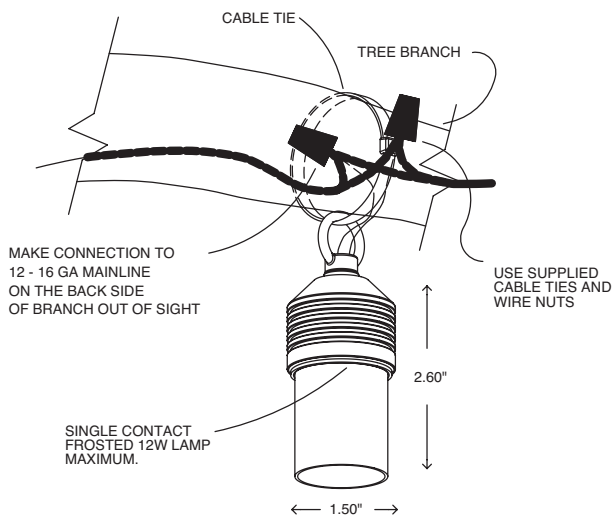

THIS FIXTURE IS DESIGNED FOR DOWN LIGHTING ONLY.
DO NOT USE IN AN UP LIGHT POSITION.

FX | LUMINAIRE®
VL-20



VITELUME® | FX LUMINAIRE®

DOWNLIGHTING



SMALL, POWERFUL
HANGING LIGHT

When a moonlighting effect is desired, but the caliper of a tree is too small to use the TrellisSolare® series, specify the FX Luminaire® ViteLume®.

This micro downlight actually hangs from the host tree by a cinch tie requiring no screws or permanent hardware. A small brass hook is also included for beam mounted applications.

Milled from heavy copper and solid brass hardware, the ViteLume incorporates a long life halogen lamp originally designed for aerospace which has an integral frosted lens. Use two or more fixtures per tree for an even illumination.

An elegant moonlight effect is produced when an evening breeze gently swings the VL making foliage shadow patterns dance on the ground below.



THE EASE OF LIGHT

Use low voltage lighting to transform and prolong the use of your garden. Highlight a magical scene and create desired effects with simple, clean fixtures. As the sky turns to a deeper shade of violet, your garden can come to life with the golden glow of copper fixtures. Unify your garden, obliterate shadows, make the shadows of branches dance on sidewalk.

DOWNLIGHTING
TREES & EAVES



ARCHITECTURAL
ACCENTS

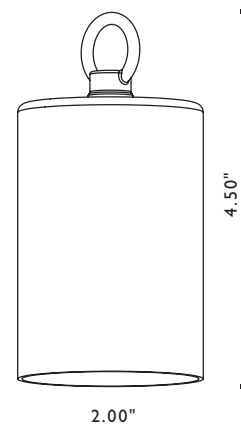

VITELUME® – ORDERING INFORMATION

The VL comes standard with 20 watt Halogen AR-11 lamp and in Copper (CU).

STANDARD PARTS:



STANDARD OPTIONS:

1 + 2 + 3 ORDERED TOGETHER ON SAME LINE

AVAILABLE LAMP CONFIGURATIONS:

Your choice of one lamp will come pre-installed.

FIXTURE/CODE	WATTAGE/CODE	BEAM/ANGLE
--------------	--------------	------------

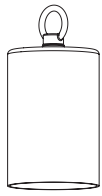
1	VL	2	HALOGEN (H) LAMP OPTIONS:
		20H	20 watt Halogen, wide 32° beam Avg. life 2000 hours
		20N-H	20 watt Halogen, narrow, 18° beam, Avg. life 2000 hours;
		20V-H	20 watt Halogen, very narrow, 6° beam, Avg. life 2000 hours

STANDARD FINISH OPTIONS:

Copper is standard. All other choices must be specified.

CODE	DESCRIPTION
 CU	Copper <i>(will naturally patina)</i>

NON-STOCKING FINISH OPTIONS:

Allow extra time for the following finish options:

3	CODE	DESCRIPTION
	BZ	Bronze Metallic
	DG	Desert Granite
	BF	Black Wrinkle
	VF	Verde Speckle
	SB	Sedona Brown
	WF	White Wrinkle
	WI	Weathered Iron
	NP	Nickel Plate

ORDERING SAMPLE:

SECTIONS:	DESCRIPTION:	WHAT TO ORDER:
1 + 2 + 3 <small>optional</small>	 +  + 	= VL-20

PHOTOMETRICS:

20 WATT WIDE

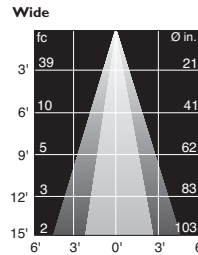

Key:
 ø: Denotes the circle diameter, in inches, at that distance from lamp (3, 6, 9', etc.)
 fc: footcandle; for approximate conversion to lumens, multiply footcandles by 10.

TREE BRANCH INSTALL DETAIL:

FX LUMINAIRE VITE LUME. HANG WITH PROVIDED CABLE TIE. CINCH CABLE TIE LOOSE TO ALLOW TREE GROWTH. REPLACE CABLE TIE EACH TIME LAMP IS REPLACED.

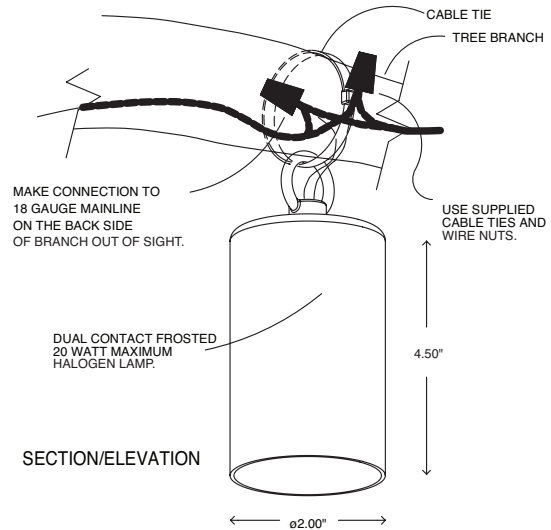

THIS FIXTURE IS DESIGNED FOR DOWN LIGHTING ONLY. DO NOT USE IN AN UP LIGHT POSITION

FX | LUMINAIRE®
TC-20



DOWNLIGHTING



TIME TESTED, FLEXIBLE
AND DURABLE

The TraveCasa® is at home in fine landscape architectural structures such as arbors, trellises or dining pavilions.

This fixture is designed to surface mount onto beams or posts. The halogen lamp is adjustable to allow maximum forward projection making this unique model well suited for illuminating steps or color pots from adjacent structures.

Milled from very heavy gauge, solid copper with stainless hardware, this luminaire will enhance any fine lighting project. The false bottom internal plate obscures wirenut connection for a clean finish.

The white powder coated unit looks great in a small modern trellis design – the copper TC works well in craftsman style structures.

TRAVECASA® | FX LUMINAIRE®



BLEND IN EFFORTLESSLY

The key to successful outdoor lighting is to incorporate the equipment into the structures or garden without introducing a conflicting design element. The TC's simple geometric form allows it to disappear into any fine trellis or arbor.

The copper will patina naturally over time and can be accelerated with solution spray. For patina formulas visit our website at www.FXL.com/patina.

Note: This fixture is designed for downlighting only.

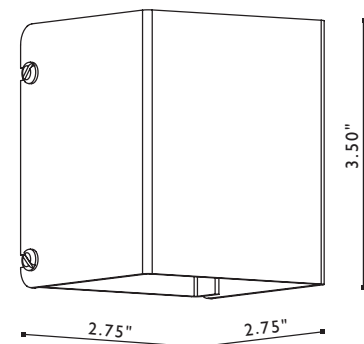

ARCHITECTURAL
ACCENTS



TRAVECASA® - ORDERING INFORMATION

The TC comes standard with any watt Halogen AR-11 lamp and in Copper (CU).

STANDARD PARTS:

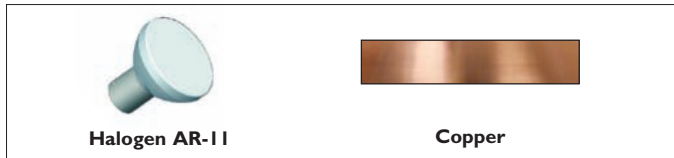

ORDERING SAMPLE:

SECTIONS:	DESCRIPTION:	WHAT TO ORDER:
1 + 2 + 3 <small>optional</small>	+ +	= TC-20

STANDARD OPTIONS:

1 + 2 + 3 ORDERED TOGETHER ON SAME LINE

AVAILABLE LAMP CONFIGURATIONS:

Your choice of one lamp will come pre-installed.

FIXTURE/CODE	WATTAGE/CODE	DESCRIPTION
1 TC 	2 HALOGEN (H) LAMP OPTIONS:	
	20H	20 watt Halogen, wide 32° beam Avg. life 2000 hours
	20N-H	20 watt Halogen, narrow, 18° beam, Avg. life 2000 hours
	20V-H	20 watt Halogen, very narrow, 6° beam, Avg. life 2000 hours

STANDARD FINISH OPTIONS:

Copper is standard. All other choices must be specified.

CODE	DESCRIPTION
CU	Copper <i>(will naturally patina)</i>

NON-STOCKING FINISH OPTIONS:

Allow extra time for the following finish options:

	3 BZ	Bronze Metallic
	DG	Desert Granite
	BF	Black Wrinkle
	VF	Verde Speckle
	SB	Sedona Brown
	WF	White Wrinkle
	WI	Weathered Iron
	NP	Nickel Plate

PHOTOMETRICS:

20 OR 35 WATT WIDE

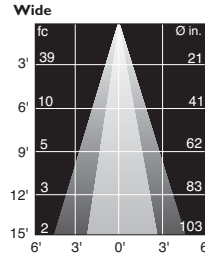

Key:

Ø: Denotes the circle diameter, in inches, at that distance from lamp (3, 6, 9', etc.)

fc: footcandle; for approximate conversion to lumens, multiply footcandles by 10.

TRELLIS MOUNT INSTALL DETAIL:

FX LUMINAIRE TRAVE CASA FIXTURE
SEE LIGHTING PLAN FOR LAMP
CONFIGURATION AND
FIXTURE COLOR.

THE FX LUMINAIRE LAMP
IS ADJUSTABLE
IN THREE DIFFERENT
PLANES
UP - DOWN
SIDE - SIDE
FRONT - BACK

USE FX LUMINAIRE
SUPPLIED WIRE NUTS

1/2" KNOCKOUT FOR
CABLE ROUTING THROUGH
REAR END OF FIXTURE

USE FX LUMINAIRE SUPPLIED
MOUNTING SCREWS

PULL CABLE THRU BACK
OF POST THEN MAKE CONNECTION
ON THE INSIDE OF THE TRAVE CASA
FIXTURE.

COVER POST GROOVE WITH A 1" X 4" OR
6" WIDE PLANT ON.

4" BY OR 6" BY POST WITH 1/2"
ROUTED SLOT ON THE INSIDE FRONT
FACE OF THE POST.

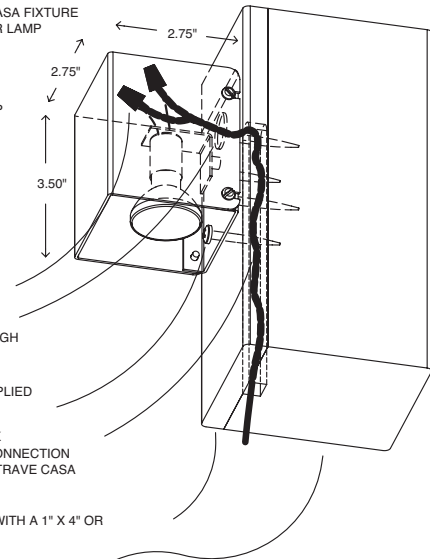

FX | LUMINAIRE®
CL-20, CL-35



DOWNLIGHTING



GLARE-FREE
ILLUMINATION

The FX Luminaire® CopertinaLuce® was created from the need for a high quality fixture that would be at home in fine landscapes or architectural structures such as trellises, arbors, or dining pavilions.

The CopertinaLuce® is precisely machined from solid copper which blends beautifully with redwood surroundings. Installation is clean and simple with low voltage lights, so there is no need for conduit which destroys the appearance of finely crafted structures.

The CL can be installed without any visible wiring or mounting hardware. This fixture is to exterior lighting what recessed lights are to interior lighting in that they both introduce glare-free illumination without being intrusive.

The copper will patina naturally over time and can be accelerated with solution spray. For patina formulas visit our website at: www.FXL.com/learning/patina.htm



LONG-TERM CONTRIBUTION

The key to successful outdoor lighting is to incorporate the equipment into the structures or garden without introducing a conflicting design element.

Milled from solid copper, the CL is engineered to make a long term contribution to any fine project. Compare FX copper luminaires with any other, you will find a dramatic difference in quality of materials, precision of fit and consistency of finish.

Note: This fixture is designed for downlighting only.

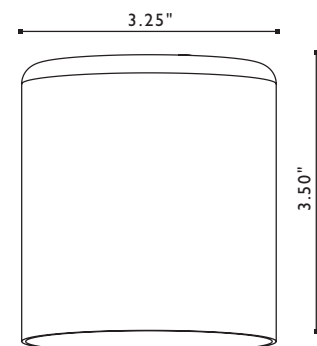

ARCHITECTURAL
ACCENTS



COPERTINALUCE® – ORDERING INFORMATION

The CL comes standard with any watt Halogen AR-11 lamp and in Copper (CU).

STANDARD PARTS:

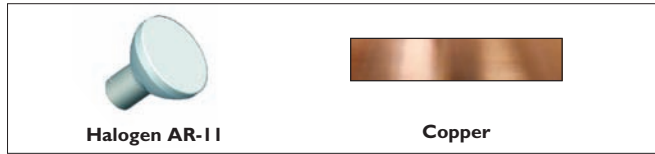

ORDERING SAMPLE:

SECTIONS:	DESCRIPTION:	WHAT TO ORDER:
1 + 2 + 3 <small>optional</small>	+ +	= CL-20

STANDARD OPTIONS:

1 + 2 + 3 ORDERED TOGETHER ON SAME LINE

AVAILABLE LAMP CONFIGURATIONS:

Your choice of one lamp will come pre-installed.

FIXTURE/CODE	WATTAGE/CODE	DESCRIPTION
1 CL 	2 HALOGEN (H) LAMP OPTIONS:	
	20H	20 watt Halogen, wide 32° beam Avg. life 2000 hours
	20N-H	20 watt Halogen, narrow, 18° beam, Avg. life 2000 hours;
	20V-H	20 watt Halogen, very narrow, 6° beam, Avg. life 2000 hours
	HALOGEN (H) MR-11 LAMP OPTIONS:	
	35H	35 watt MR-11 Halogen, wide 32° beam Avg. life 2000 hours

STANDARD FINISH OPTIONS:

Copper is standard. All other choices must be specified.

CODE	DESCRIPTION
CU	Copper <i>(will naturally patina)</i>

NON-STOCKING FINISH OPTIONS:

Allow extra time for the following finish options:

	3 BZ	Bronze Metallic
	DG	Desert Granite
	BF	Black Wrinkle
	VF	Verde Speckle
	SB	Sedona Brown
	WF	White Wrinkle
	WI	Weathered Iron
	NP	Nickel Plate

PHOTOMETRICS:

20 OR 35 WATT WIDE

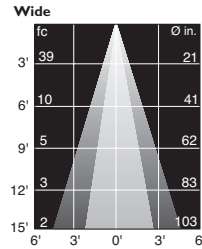

Key:

∅: Denotes the circle diameter, in inches, at that distance from lamp (3, 6, 9', etc.)

fc: footcandle; for approximate conversion to lumens, multiply footcandles by 10.

FX | LUMINAIRE®
 TS-20, TS-35, TS-50



DOWNLIGHTING



SMOOTH, PRECISE
 MOONLIGHTING

Our TrellisSolare® is currently the most advanced micro downlight available. Machined from aerospace grade aluminum alloy and finished with an industrial grade polyester powdercoat, the TS is built to last. The mounting base swivels and pivots on nylon bushings, allowing for smooth, precise aiming after installation.

This fixture is an outdoor “track light” giving the exterior lighting designer a full range of previously interior only lighting effects. Deep cowling provides unsurpassed glare control, thereby avoiding hot spots typical of most downlights.

Because of its micro size and high intensity, the TS-20 is a natural for moonlighting from small trees and downlighting from medium size patio trees. Specify TS-50 for larger specimens and controlled lighting.

TRELLISOLARE® | FX LUMINAIRE®

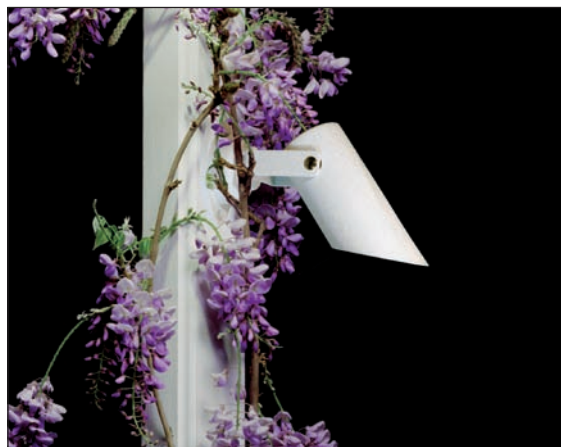

LANDSCAPE TRACK LIGHT

With a lamp range from 20–50 watts, the TS series can introduce glare-free illumination to a wide variety of outdoor environments. This trellis provides a perfect platform for the TS, and the white finish blends in perfectly.

The copper will patina naturally over time and can be accelerated with solution spray. For patina formulas visit our website at www.FXL.com/patina.

Note: This fixture is designed for downlighting only.

ARCHITECTURAL ACCENTS DOWNLIGHTING

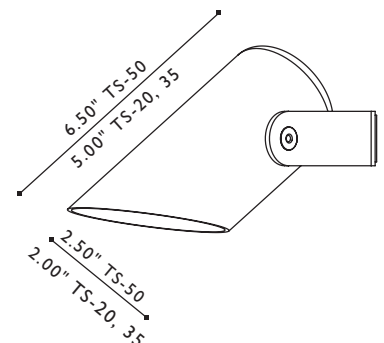

TRELLISOLARE® – ORDERING INFORMATION

The TS comes standard with any watt Halogen AR lamp and in Bronze Metallic (BZ).

STANDARD PARTS:

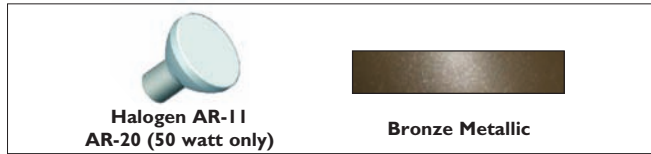

ORDERING SAMPLE:

SECTIONS:	DESCRIPTION:	WHAT TO ORDER:
1 + 2 + 3 <small>optional</small>	+ +	= TS-20-CU
A	VersaBoX	= VB

STANDARD OPTIONS:

1 + 2 + 3 ORDERED TOGETHER ON SAME LINE

AVAILABLE LAMP CONFIGURATIONS:

Your choice of one lamp will come pre-installed.

FIXTURE/CODE	WATTAGE/CODE	DESCRIPTION
1 TS 	2 HALOGEN (H) LAMP OPTIONS:	
	20H	20 watt Halogen, wide 32° beam Avg. life 2000 hours
	20N-H	20 watt Halogen, narrow, 18° beam, Avg. life 2000 hours;
	20V-H	20 watt Halogen, very narrow, 6° beam, Avg. life 2000 hours
	50H	50 watt Halogen AR-20, wide 25° beam Avg. life 2000 hours
	50N-H	50 watt Halogen AR-20, narrow 10° beam Avg. life 2000 hours
	HALOGEN (H) LAMP OPTIONS:	
	35H	35 watt Halogen MR-11, wide 32° beam Avg. life 2000 hours

STANDARD FINISH OPTIONS:

Bronze Metallic is standard. All other choices must be specified.



NON-STOCKING FINISH OPTIONS:

Allow extra time for the following finish options:

	CODE	DESCRIPTION
	3 CU	Copper (will naturally patina)
	DG	Desert Granite
	BF	Black Wrinkle
	VF	Verde Speckle
	SB	Sedona Brown
	WF	White Wrinkle
	WI	Weathered Iron
	NP	Nickel Plate

NON-STANDARD OPTIONS:

A MUST BE ORDERED ON SEPARATE LINE!

ADDITIONAL MOUNTING OPTIONS:

All mounting options will arrive in separate box.

	CODE	DESCRIPTION	SIZE
	A MJ-TS	Mini J-Box®	3.50" x 2.125" x 1.320"
	VB-TS	VersaBoX®	2.50" x 2.00"

PHOTOMETRICS:

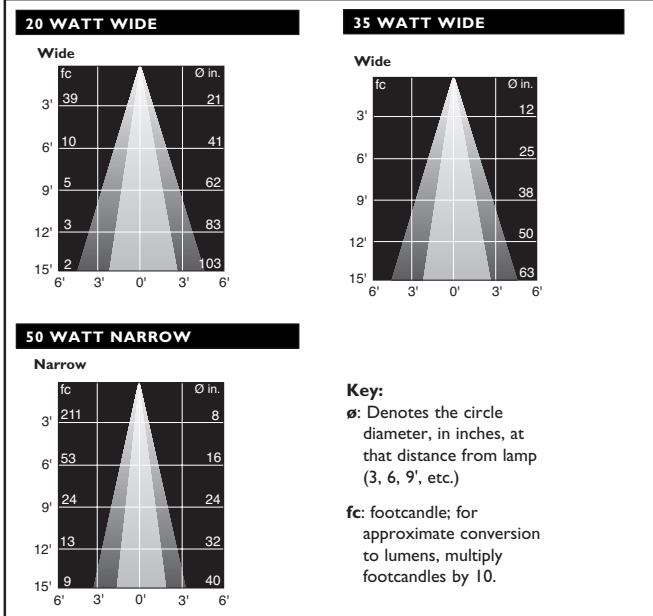

FX | LUMINAIRE®
DP-10



**ULTRA-MICRO SIZE,
 HALOGEN POWER**

The DiamantePiccolo® is the most petite luminaire in the FX family. Milled from extra-heavy gauge copper and solid brass, the patent pending DP is engineered to survive.

The beam spread of the DP provides maximum projection with minimum glare.

This model is perfect for coastal exposures or areas where irrigation water contains high levels of mineral or caustic salts.

The copper will patina naturally over time and can be accelerated with solution spray. For patina formulas visit our website at: www.FXL.com/learning/patina.htm

DIAMANTEPICCOLO® | FX LUMINAIRE®



LIFETIME PERFECTION

At FX, we engineer fixtures from the inside out. Our use of semi precious metals, aerospace sealants and materials is without peer. This commitment to excellence provides your client with decades of problem-free ownership.

Compare FX copper luminaires with any other, and you will find a dramatic difference in quality of materials, precision of fit and consistency of finish.

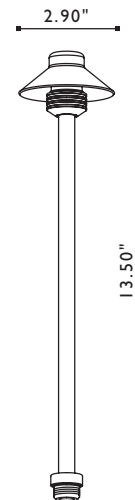

DIAMANTEPICCOLO® – ORDERING INFORMATION

The DP comes standard with 10 watt Xenon G4 lamp, Super Slot Spike®, and in Copper (CU).

STANDARD OPTIONS:

1 + 2 + 3 + 4 ORDERED TOGETHER ON SAME LINE

AVAILABLE LAMP CONFIGURATIONS:

Your choice of one lamp will come pre-installed.

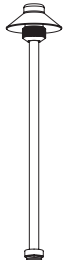
FIXTURE/CODE	WATTAGE/CODE	AVG. LIFE HOUR
1 	2 XENON LAMP OPTIONS:	
	10	10,000
	HALOGEN (H) LAMP OPTIONS:	
	10H	2000

STANDARD RISER OPTIONS::

Your choice of one riser option will come pre-assembled.

Riser Specs: Copper 0.5" Diameter

	CODE	DESCRIPTION
3 	8R	8" Riser
	12R	12" Riser
	18R	18" Riser

STANDARD FINISH OPTIONS:

Copper is standard. All other choices must be specified.

	CODE	DESCRIPTION
	CU	Copper (will naturally patina)

NON-STOCKING FINISH OPTIONS:

Allow extra time for the following finish options:

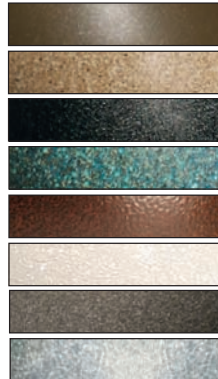
	CODE	DESCRIPTION
4 	BZ	Bronze Metallic
	DG	Desert Granite
	BF	Black Wrinkle
	VF	Verde Speckle
	SB	Sedona Brown
	WF	White Wrinkle
	WI	Weathered Iron
	NP	Nickel Plate

STANDARD PARTS:



ORDERING SAMPLE:

SECTIONS:	DESCRIPTION:	WHAT TO ORDER:
1 + 2 + 3 + 4 <small>optional</small>	 +  +  + 	=DP-10-12R
A	PostMount®	= PM

NON-STANDARD OPTIONS:

MUST BE ORDERED ON SEPARATE LINE!

ADDITIONAL MOUNTING OPTIONS:

Comes pre-assembled with Super Slot Spike®.

All other mounting options will arrive in separate box.

	CODE	DESCRIPTION	SIZE
A 	CDS	CapannaDiNoce®	2.00" x 10.00"
	SJ	SuperJ-boX®	2.50" x 12.00"
	PM	PostMount®	2.50" x 13.00"

PHOTOMETRICS:



Distance	Footcandle Power (12R riser)	
	DP-5	DP-10
14'		
12'	2'	2.6
10'	4'	.57
	6'	.13
8'	8'	.05
	10'	.03
6'	12'	.02
	14'	.0
4'		
	2'	

For conversion to lumens: Multiply footcandles x 10. See FX glossary for a full description of fc and lumens.

FX | LUMINAIRE®
SP-10, SP-15, SP-20



**MICRO SIZE,
 HALOGEN POWER**

One of the challenges today's lighting designers face is to provide adequate pedestrian illumination from increasingly narrow planter areas. To address this problem our engineering staff developed the solid copper micro SaguaroPetite®.

This patent pending luminaire, milled from extra-heavy gauge copper and solid brass, is designed for today's crowded planters. When incorporated with plant material, the SP simply disappears into the garden.

The beam spread of the SP provides maximum projection with minimum glare, thereby producing a soft glare-free light up to 28' in diameter!

The copper will patina naturally over time and can be accelerated with solution spray – for patina formula visit our website at: www.FXL.com/learning/patina.htm

SAGUAROPETITE® | FX LUMINAIRE®



VISUAL TRANSPARENCY

This graceful micro luminaire is equally at home in the lush perennial borders of Monterey as it is in a xeriscape theme in Scottsdale. The small scale of the SP allows the designer to unobtrusively introduce low level, smooth edge illumination which complements any garden style.

And since the SP is precisely machined from solid copper and brass, it will last for decades even at the ocean's edge.

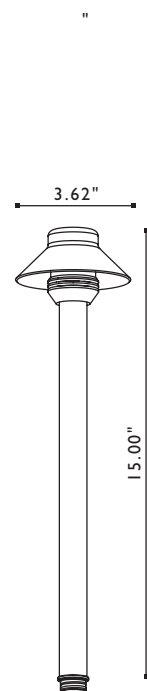

SAGUARO PETITE® – ORDERING INFORMATION

The SP comes standard with 20 watt Xenon G4 lamp, Super Slot Spike®, and in Copper (CU).

STANDARD OPTIONS:

1 + 2 + 3 + 4 ORDERED TOGETHER ON SAME LINE

AVAILABLE LAMP CONFIGURATIONS:

Your choice of one lamp will come pre-installed.

FIXTURE/CODE	WATTAGE/CODE	AVG. LIFE HOUR
1 	2 XENON LAMP OPTIONS:	
	10	10,000
	15	10,000
	20	5000
	HALOGEN (H) LAMP OPTIONS:	
	10H	2000
	20H	2000

STANDARD RISER OPTIONS:

Your choice of one riser option will come pre-assembled.

Riser Specs: Copper 0.75" Diameter

CODE	DESCRIPTION
3 	8R 8" Riser
	12R 12" Riser
	18R 18" Riser

STANDARD FINISH OPTIONS:

Copper is standard. All other choices must be specified.

CODE	DESCRIPTION
	CU Copper (will naturally patina)

NON-STOCKING FINISH OPTIONS:

Allow extra time for the following finish options:

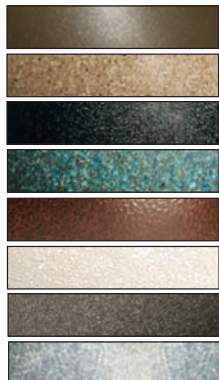
	4 BZ	Bronze Metallic
	DG	Desert Granite
	BF	Black Wrinkle
	VF	Verde Speckle
	SB	Sedona Brown
	WF	White Wrinkle
	WI	Weathered Iron
	NP	Nickel Plate

STANDARD PARTS:



ORDERING SAMPLE:

SECTIONS:	DESCRIPTION:	WHAT TO ORDER:
1 + 2 + 3 + 4 <small>optional</small>		= SP-15-12R
A	PostMount	= PM

NON-STANDARD OPTIONS:

MUST BE ORDERED ON SEPARATE LINE!

ADDITIONAL MOUNTING OPTIONS:

Comes pre-assembled with Super Slot Spike®.

All other mounting options will arrive in separate box.

CODE	DESCRIPTION	SIZE
A 	CDS CapannaDiNoce®	2.00" x 10.00"
	SJ SuperJ-boX®	2.50" x 12.00"
	PM PostMount®	2.50" x 13.00"

PHOTOMETRICS:

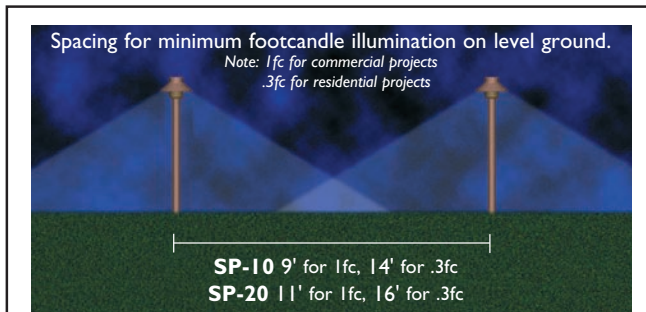

Distance	Footcandle Power (12R riser)	
	SP-10	SP-20
2'	1.7	2.6
4'	.31	.57
6'	.10	.13
8'	.04	.05
10'	.02	.03
12'	.01	.02
14'		.01

For conversion to lumens: Multiply footcandles x 10. See FX glossary for a full description of fc and lumens.

FX | LUMINAIRE®
AP-10, AP-15, AP-20

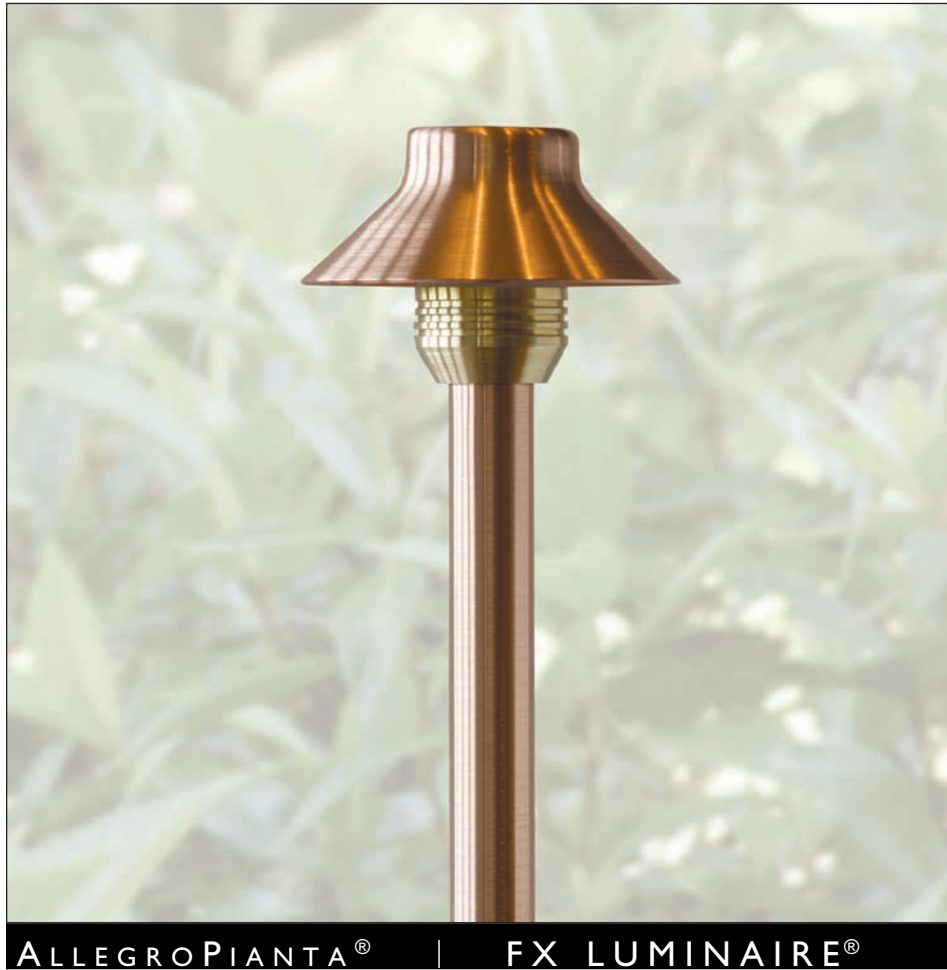

WHAT'S OLD, IS NEW!

AllegroPianta® is the new sister fixture to our SaguaroPetite® and our pathlite family.

We have extended our pathlite family with the new AllegroPianta® (AP). It is the newest addition to the petite family. Similar to the SP in size and shape, the AP has a smooth, all copper top, finish, while the SP has a sharp and stylish brass top.

This patent pending luminaire, milled from extra-heavy gauge copper and solid brass, is designed for today's crowded planters. When incorporated with plant material, the AP simply disappears into the garden.

The copper will patina naturally over time and can be accelerated with solution spray – for patina formula visit our website at: www.FXL.com/learning/patina.htm

ALLEGROPIANTA® | FX LUMINAIRE®



CONCEALED ILLUMINATION

This sleek and sophisticated micro luminaire will lead an enchanting path to your suburban home. The small scale of the copper AP can camouflage well into any garden landscape.

And since the AP is precisely machined from solid copper, it will last for decades even at the ocean's edge.

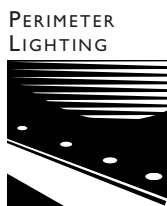
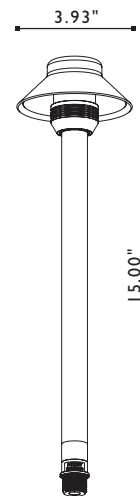

ALLEGROPIANTA® – ORDERING INFORMATION

The AP comes standard with 20 watt Xenon G4 lamp, Super Slot Spike®, and in Copper (CU).

STANDARD OPTIONS:

1 + 2 + 3 + 4 ORDERED TOGETHER ON SAME LINE

AVAILABLE LAMP CONFIGURATIONS:

Your choice of one lamp will come pre-installed.

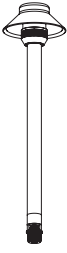
FIXTURE/CODE	WATTAGE/CODE	AVG. LIFE HOUR
1 	2 XENON LAMP OPTIONS:	
	10	10,000
	15	10,000
	20	5000
	HALOGEN (H) LAMP OPTIONS:	
	10H	2000
	20H	2000

STANDARD RISER OPTIONS:

Your choice of one riser option will come pre-assembled.

Riser Specs: Copper 0.75" Diameter

	CODE	DESCRIPTION
	3 8R	8" Riser
	12R	12" Riser
	18R	18" Riser







STANDARD FINISH OPTIONS:

Copper is standard. All other choices must be specified.

	CODE	DESCRIPTION
	CU	Copper <i>(will naturally patina)</i>

NON-STOCKING FINISH OPTIONS:



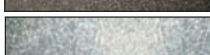
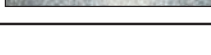

Allow extra time for the following finish options:

	CODE	DESCRIPTION
	4 BZ	Bronze Metallic
	DG	Desert Granite
	BF	Black Wrinkle
	VF	Verde Speckle
	SB	Sedona Brown
	WF	White Wrinkle
	WI	Weathered Iron
	NP	Nickel Plate

STANDARD PARTS:



ORDERING SAMPLE:

SECTIONS:	DESCRIPTION:	WHAT TO ORDER:
1 + 2 + 3 + 4 <small>optional</small>	 +  +  + 	= AP-15-12R
A and/or B	PostMount	= PM
	26' Lead Wire	= 26

NON-STANDARD OPTIONS:

MUST BE ORDERED ON SEPARATE LINE!

ADDITIONAL MOUNTING OPTIONS:

Comes pre-assembled with Super Slot Spike®.

All other mounting options will arrive in separate box.

	CODE	DESCRIPTION	SIZE
	A CDS	CapannaDiNoce®	2.00" x 10.00"
	SJ	SuperJ-boX®	2.50" x 12.00"
	PM	PostMount®	2.50" x 13.00"

ADDITIONAL LEAD WIRE OPTIONS:

Fixture comes standard with a 34" (.9m) lead wire.

	B 26	26' Lead Wire
--------------------------------------------------------------------------------------	-------------	---------------

Note: The 26' lead wire will come at an additional cost.

FX | LUMINAIRE®
BD-10, BD-15, BD-20



DEPENDABLE, DURABLE, PRACTICAL

Don't let its size fool you: the strength of the BD will demand respect. Owners of small scale landscapes and planters will find this remarkable luminaire essential. It is a perfect example of how to do more with less.

Compare our pathlites with any other and you will see whose quality of materials, precision of fit and consistency of finishing stands out above the rest.

This model is perfect for coastal exposures or areas where irrigation water contains high levels of mineral or caustic salts.

The copper will patina naturally over time and can be accelerated with solution spray – for patina formula visit our website at: www.FXL.com/learning/patina.htm

BELLADONNA® | FX LUMINAIRE®



HARVEST OF LIGHT

Recreate the glow of the sunset with low voltage lighting. This can create beautiful scenery, while establishing boundaries. As night falls, create simple and elegant effects with the use of strategically placed luminaires. While darkness move in gradually, your lighting will fill your garden with life and warmth. With the right landscape lighting, private and intimate garden settings will stay just that. There is no need to overpower the scene with light. Distribute your light evenly, highlighting your gardens strengths and downplaying its weaknesses.

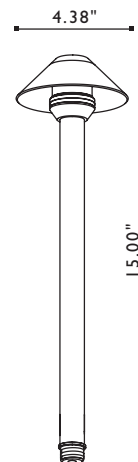

BELLADONNA® – ORDERING INFORMATION

The BD comes standard with 20 watt Xenon G4 lamp, Super Slot Spike®, and in Copper (CU).

STANDARD OPTIONS:

1 + 2 + 3 + 4 ORDERED TOGETHER ON SAME LINE

AVAILABLE LAMP CONFIGURATIONS:

Your choice of one lamp will come pre-installed.

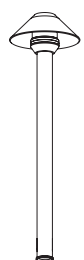
FIXTURE/CODE	WATTAGE/CODE	AVG. LIFE HOUR
	2 XENON LAMP OPTIONS:	
	10	10,000
	15	10,000
	20	5000
	HALOGEN (H) LAMP OPTIONS:	
	10H	2000
	20H	2000

STANDARD RISER OPTIONS:

Your choice of one riser option will come pre-assembled.

Riser Specs: Copper 0.75" Diameter

	CODE	DESCRIPTION
	3	
	8R	8" Riser
	12R	12" Riser
	18R	18" Riser

STANDARD FINISH OPTIONS:

Copper is standard. All other choices must be specified.

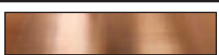
	CODE	DESCRIPTION
	CU	Copper (will naturally patina)

NON-STOCKING FINISH OPTIONS:

Allow extra time for the following finish options:

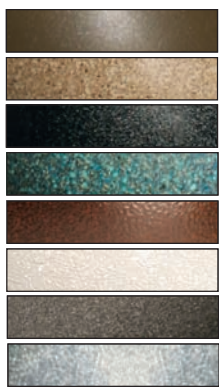
	CODE	DESCRIPTION
	4	
	BZ	Bronze Metallic
	DG	Desert Granite
	BF	Black Wrinkle
	VF	Verde Speckle
	SB	Sedona Brown
	WF	White Wrinkle
	WI	Weathered Iron
	NP	Nickel Plate

STANDARD PARTS:

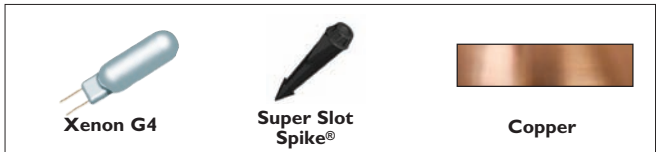

ORDERING SAMPLE:

SECTIONS:	DESCRIPTION:	WHAT TO ORDER:
1 + 2 + 3 + 4 <small>optional</small>	 +  + 	= BD-10-12R
A	PostMount®	= PM

NON-STANDARD OPTIONS:

MUST BE ORDERED ON SEPARATE LINE!

ADDITIONAL MOUNTING OPTIONS:

Comes pre-assembled with Super Slot Spike®.

All other mounting options will arrive in separate box.

	CODE	DESCRIPTION	SIZE
	A		
	CDS	CapannaDiNoce®	2.00" x 10.00"
	SJ	SuperJ-boX®	2.50" x 12.00"
	PM	PostMount®	2.50" x 13.00"

PHOTOMETRICS:

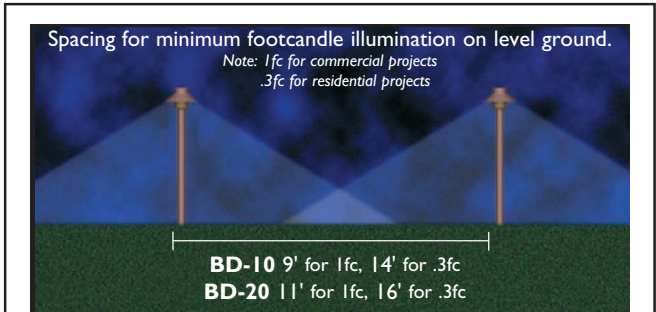

Distance	Footcandle Power (12R riser)	
	BD-10	BD-20
14'		
12'	2'	2.6
10'	4'	.57
	6'	.13
8'	8'	.05
	10'	.03
6'	12'	.02
	14'	.01
4'		
2'		

For conversion to lumens: Multiply footcandles x 10. See FX glossary for a full description of fc and lumens.

FX | LUMINAIRE®
SC-10, SC-15, SC-20



**SOPHISTICATION
 INSIDE AND OUT**

Uniquely suited for small gardens or planters, the SC is sure to be a timeless addition to any landscape. Its precision design and high performance, means you can rely on it for enduring quality.

At FX, we engineer fixtures from the inside out. Our use of semi precious metals, aerospace sealants and materials is without peer. This commitment to excellence provides you with decades of problem-free ownership.

The high output, long-life halogen lamp assembly reduces operating and maintenance costs.

The copper will patina naturally over time and can be accelerated with solution spray – for patina formula visit our website at: www.FXL.com/learning/patina.htm

SFERICO CALDO® | FX LUMINAIRE®



THE ALLURE OF LIGHT

All of our fixtures are a product of nature, with each Luminaire carefully designed. From the subtle tones of nature to the brilliant explosions of color, our luminaries will provide a feeling of elegance and romance that will turn any ordinary garden into something well beyond. For those who appreciate the best, and to those who accept no less, we offer our line of copper pathlites. They are a result of timeless craftsmanship that endures.

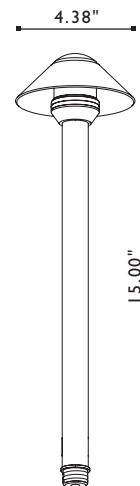

SFERICOCALDO® - ORDERING INFORMATION

The SC comes standard with 20 watt Xenon G4 lamp, Super Slot Spike®, and in Copper (CU).

STANDARD OPTIONS:

1 + 2 + 3 + 4 ORDERED TOGETHER ON SAME LINE

AVAILABLE LAMP CONFIGURATIONS:

Your choice of one lamp will come pre-installed.

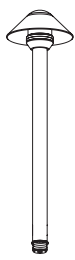
FIXTURE/CODE	WATTAGE/CODE	AVG. LIFE HOUR
	2 XENON LAMP OPTIONS:	
	10	10,000
	15	10,000
	20	5000
	HALOGEN (H) LAMP OPTIONS:	
	10H	2000
	20H	2000

STANDARD RISER OPTIONS:

Your choice of one riser option will come pre-assembled.

Riser Specs: Copper 0.75" Diameter

	CODE	DESCRIPTION
	3	
	8R	8" Riser
	12R	12" Riser
	18R	18" Riser

STANDARD FINISH OPTIONS:

Copper is standard. All other choices must be specified.

	CODE	DESCRIPTION
	CU	Copper (will naturally patina)

NON-STOCKING FINISH OPTIONS:

Allow extra time for the following finish options:

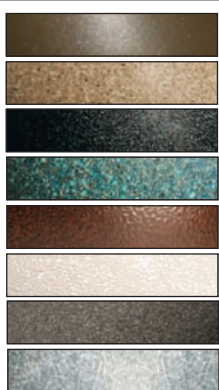
	CODE	DESCRIPTION
	4	
	BZ	Bronze Metallic
	DG	Desert Granite
	BF	Black Wrinkle
	VF	Verde Speckle
	SB	Sedona Brown
	WF	White Wrinkle
	WI	Weathered Iron
	NP	Nickel Plate

STANDARD PARTS:



ORDERING SAMPLE:

SECTIONS:	DESCRIPTION:	WHAT TO ORDER:
1 + 2 + 3 + 4 <small>optional</small>		= SC-10-12R
A	PostMount®	= PM

NON-STANDARD OPTIONS:

MUST BE ORDERED ON SEPARATE LINE!

ADDITIONAL MOUNTING OPTIONS:

Comes pre-assembled with Super Slot Spike®.

All other mounting options will arrive in separate box.

	CODE	DESCRIPTION	SIZE
	A		
	CDS	CapannaDiNoce®	2.00" x 10.00"
	SJ	SuperJ-boX®	2.50" x 12.00"
	PM	PostMount®	2.50" x 13.00"

PHOTOMETRICS:

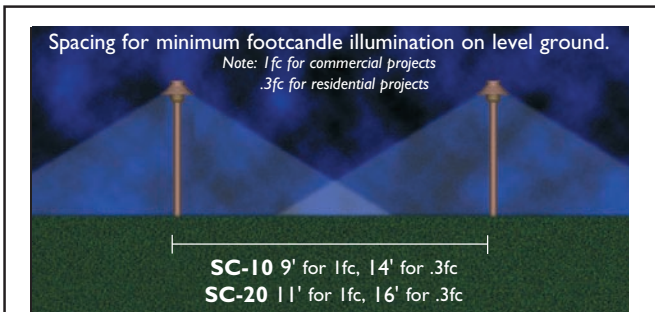

Distance	Footcandle Power (12R riser)	
	SC-10	SC-20
2'	1.7	2.6
4'	.31	.57
6'	.10	.13
8'	.04	.05
10'	.02	.03
12'	.01	.02
14'		.01

For conversion to lumens: Multiply footcandles x 10. See FX glossary for a full description of fc and lumens.

FX | LUMINAIRE®
EA-10, EA-15, EA-20



ELFOANGOLOSO® | FX LUMINAIRE®

UNFORGETTABLE STYLE AND PERFORMANCE

The sophisticated styling of the EA makes itself right at home with the rest of the veteran pathlites. In addition to its distinguished shape, its high performance is what will make this luminaire a favorite.

Compare FX copper luminaires with any other, and you will find a dramatic difference in quality of materials, precision of fit and consistency of finish.

All FX copper models are well suited for coastal exposures or areas where irrigation water contains high levels of mineral or caustic salts.

The copper will patina naturally over time and can be accelerated with solution spray – for patina formula visit our website at: www.FXL.com/learning/patina.htm



GET COMFORTABLE

Create a sense of excitement and anticipation night after night when the sun is going down by creating an outdoor living area with the use of landscape lighting. Use lighting to reveal dramatic textures of trunks or the delicateness of petals. As night falls, your outdoor living space is now prepared for the evening. As the night falls, the lights truly allow the scene to come to life. You can also use lighting to bring a sense of privacy and comfort to an open area that could easily feel exposed.

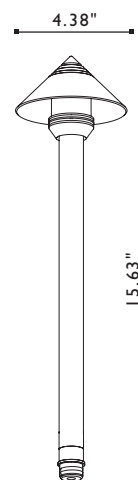

ELFOANGOLOSO® – ORDERING INFORMATION

The EA comes standard with 20 watt Xenon G4 lamp, Super Slot Spike®, and in Copper (CU).

STANDARD OPTIONS:

1 + 2 + 3 + 4 ORDERED TOGETHER ON SAME LINE

AVAILABLE LAMP CONFIGURATIONS:

Your choice of one lamp will come pre-installed.

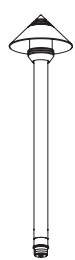
FIXTURE/CODE	WATTAGE/CODE	AVG. LIFE HOUR
	2 XENON LAMP OPTIONS:	
	10	10,000
	15	10,000
	20	5000
	HALOGEN (H) LAMP OPTIONS:	
	10H	2000
	20H	2000

STANDARD RISER OPTIONS:

Your choice of one riser option will come pre-assembled.

Riser Specs: Copper 0.75" Diameter

CODE	DESCRIPTION
	3 8R 8" Riser
	12R 12" Riser
	18R 18" Riser

STANDARD FINISH OPTIONS:

Copper is standard. All other choices must be specified.

CODE	DESCRIPTION
	CU Copper <i>(will naturally patina)</i>

NON-STOCKING FINISH OPTIONS:

Allow extra time for the following finish options:

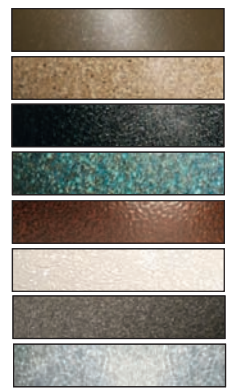
CODE	DESCRIPTION
	4 BZ Bronze Metallic
	DG Desert Granite
	BF Black Wrinkle
	VF Verde Speckle
	SB Sedona Brown
	WF White Wrinkle
	WI Weathered Iron
	NP Nickel Plate

STANDARD PARTS:

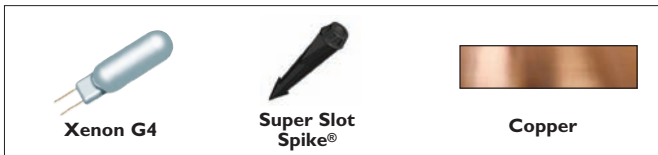

ORDERING SAMPLE:

SECTIONS:	DESCRIPTION:	WHAT TO ORDER:
1 + 2 + 3 + 4 <small>optional</small>	 +  +  + 	= EA-10-12R
A	PostMount®	= PM

NON-STANDARD OPTIONS:

MUST BE ORDERED ON SEPARATE LINE!

ADDITIONAL MOUNTING OPTIONS:

Comes pre-assembled with Super Slot Spike®.

All other mounting options will arrive in separate box.

CODE	DESCRIPTION	SIZE
	A CDS CapannaDiNoce®	2.00" x 10.00"
	SJ SuperJ-boX®	2.50" x 12.00"
	PM PostMount®	2.50" x 13.00"

PHOTOMETRICS:

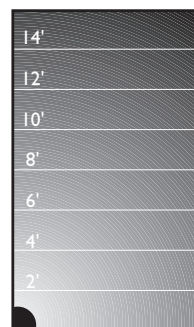
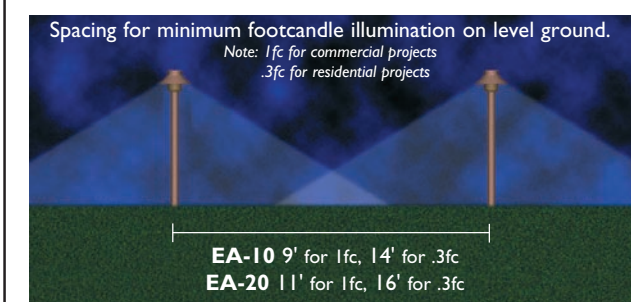

Footcandle Power (12R riser)

Distance	EA-10	EA-20
2'	1.7	2.6
4'	.31	.57
6'	.10	.13
8'	.04	.05
10'	.02	.03
12'	.01	.02
14'		.01

For conversion to lumens: Multiply footcandles x 10. See FX glossary for a full description of fc and lumens.

FX | LUMINAIRE®
PR-10, PR-15, PR-20



**ALLURING DESIGN,
 GRACEFUL PERFORMANCE**

Designed specifically for those who prefer soft rounded shapes, to angles, the PR is unlike any other. Its unrivaled performance coupled with its exceptional pricing will fit nicely into any demanding design.

This patent pending luminaire, milled from extra-heavy gauge copper and solid brass, is designed for today's crowded planters. When incorporated with plant material, the PR simply disappears into the garden.

Compare FX copper luminaires with any other, and you will find a dramatic difference in quality of materials, precision of fit and consistency of finish.

The copper will patina naturally over time and can be accelerated with solution spray – for patina formula visit our website at: www.FXL.com/learning/patina.htm

PETTORISOLUTO® | FX LUMINAIRE®



PERFECT HARMONY

Highlight your detailed or simplistic garden while making whatever is beyond it remain in darkness. Lighting should be used to highlight, not overpower. Use it to create boundaries and mystery. Lighting your landscape can be compared to the art of stage lighting. You must know where to strategically place your lighting to create emotion.

You can illuminate paths, focus attention on fountains and enhance a gorgeous area of fauna. Different types of lighting can combine to create an intimate scene.

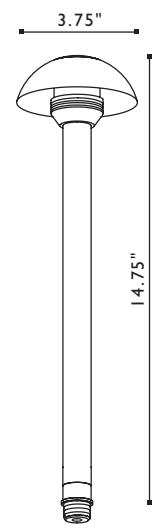

PETTORESOLUTO® – ORDERING INFORMATION

The PR comes standard with a 20 watt Xenon G4 lamp, Super Slot Spike®, and in Copper (CU).

STANDARD OPTIONS:

1 + 2 + 3 + 4 ORDERED TOGETHER ON SAME LINE

AVAILABLE LAMP CONFIGURATIONS:

Your choice of one lamp will come pre-installed.

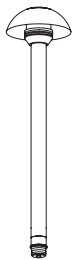
FIXTURE/CODE	WATTAGE/CODE	AVG. LIFE HOUR
	2 XENON LAMP OPTIONS:	
	10	10,000
	15	10,000
	20	5000
	HALOGEN (H) LAMP OPTIONS:	
	10H	2000
	20H	2000

STANDARD RISER OPTIONS:

Your choice of one riser option will come pre-assembled.

Riser Specs: Copper 0.75" Diameter

CODE	DESCRIPTION
	3 8R 8" Riser
	12R 12" Riser
	18R 18" Riser

STANDARD FINISH OPTIONS:

Copper is standard. All other choices must be specified.

CODE	DESCRIPTION
	CU Copper (will naturally patina)

NON-STOCKING FINISH OPTIONS:

Allow extra time for the following finish options:

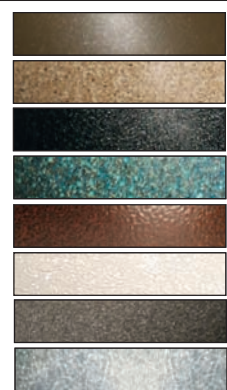
	4 BZ	Bronze Metallic
	DG	Desert Granite
	BF	Black Wrinkle
	VF	Verde Speckle
	SB	Sedona Brown
	WF	White Wrinkle
	WI	Weathered Iron
	NP	Nickel Plate

STANDARD PARTS:



ORDERING SAMPLE:

SECTIONS:	DESCRIPTION:	WHAT TO ORDER:
1 + 2 + 3 + 4 <small>optional</small>	 +  +  + 	= PR-10-12R
A	PostMount®	= PM

NON-STANDARD OPTIONS:

MUST BE ORDERED ON SEPARATE LINE!

ADDITIONAL MOUNTING OPTIONS:

Comes pre-assembled with Super Slot Spike®.

All other mounting options will arrive in separate box.

CODE	DESCRIPTION	SIZE
	A CDS	CapannaDiNoce® 2.00" x 10.00"
	SJ	SuperJ-boX® 2.50" x 12.00"
	PM	PostMount® 2.50" x 13.00"

PHOTOMETRICS:

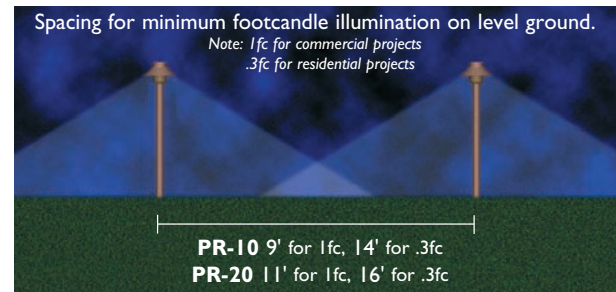

Distance	Footcandle Power (12R riser)	
	PR-10	PR-20
2'	1.7	2.6
4'	.31	.57
6'	.10	.13
8'	.04	.05
10'	.02	.03
12'	.01	.02
14'	.01	.01

For conversion to lumens: Multiply footcandles x 10. See FX glossary for a full description of fc and lumens.

FX | LUMINAIRE®
PF-10, PF-15, PF-20



**COMPACT STYLING,
 UNPARALLELED OUTPUT**

This scaled down version of the classic DelMare delivers high-impact in a small package. We are positive that this intricately designed luminaire is sure to be unforgettable. FX signifies quality, but the PF signifies style.

The most successful gardens are a harmonious blend of organic materials. The FX copper line is the perfect match to wood, masonry, and plant materials since the natural patina process allows each fixture to melt into its background.

Compare our pathlites with any other and you will see whose quality of materials, precision of fit and consistency of finishing stands out above the rest.

The copper will patina naturally over time and can be accelerated with solution spray – for patina formula visit our website at: www.FXL.com/learning/patina.htm

PEZZOFORTE® | FX LUMINAIRE®



SIMPLE PERFECTION

When thinking outdoor lighting- you should think permanence. Candles are nice and inexpensive, but only landscape lighting can provide safety. Precision placed lighting can reinforce the feeling of intimacy and warmth. The ways to create a wonderful outdoor space are infinite. You no longer have to use a flood light to overpower the space with light.

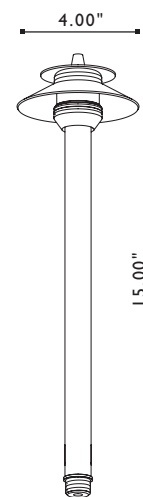

PEZZOFORTE® – ORDERING INFORMATION

The PF comes standard with a 20 watt Xenon G4 lamp, Super Slot Spike®, and in Copper (CU).

STANDARD OPTIONS:

1 + 2 + 3 + 4 ORDERED TOGETHER ON SAME LINE

AVAILABLE LAMP CONFIGURATIONS:

Your choice of one lamp will come pre-installed.

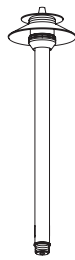
FIXTURE/CODE	WATTAGE/CODE	AVG. LIFE HOUR
1 PF 	2 XENON LAMP OPTIONS:	
	10	10,000
	15	10,000
	20	5000
	HALOGEN (H) LAMP OPTIONS:	
	10H	2000
	20H	2000

STANDARD RISER OPTIONS:

Your choice of one riser option will come pre-assembled.

Riser Specs: Copper 0.75" Diameter

	CODE	DESCRIPTION
	3 8R	8" Riser
	12R	12" Riser
	18R	18" Riser

STANDARD FINISH OPTIONS:

Copper is standard. All other choices must be specified.

	CODE	DESCRIPTION
	CU	Copper (will naturally patina)

NON-STOCKING FINISH OPTIONS:

Allow extra time for the following finish options:

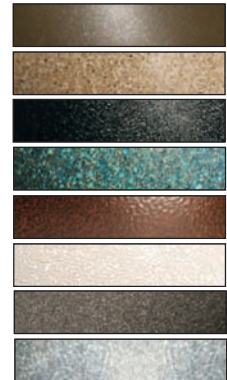
	CODE	DESCRIPTION
	4 BZ	Bronze Metallic
	DG	Desert Granite
	BF	Black Wrinkle
	VF	Verde Speckle
	SB	Sedona Brown
	WF	White Wrinkle
	WI	Weathered Iron
	NP	Nickel Plate

STANDARD PARTS:



ORDERING SAMPLE:

SECTIONS:	DESCRIPTION:	WHAT TO ORDER:
1 + 2 + 3 + 4 <small>optional</small>		= PF-10-12R
A	PostMount®	= PM

NON-STANDARD OPTIONS:

MUST BE ORDERED ON SEPARATE LINE!

ADDITIONAL MOUNTING OPTIONS:

Comes pre-assembled with Super Slot Spike®.

All other mounting options will arrive in separate box.

	CODE	DESCRIPTION	SIZE
	A CDS	CapannaDiNoce®	2.00" x 10.00"
	SJ	SuperJ-boX®	2.50" x 12.00"
	PM	PostMount®	2.50" x 13.00"

PHOTOMETRICS:

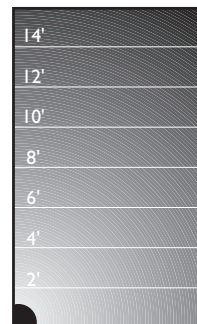
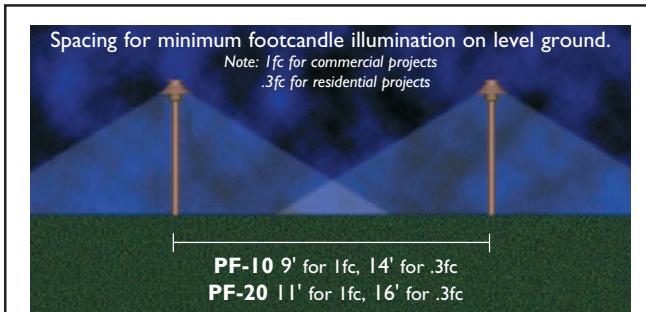

Footcandle Power (12R riser)

Distance	PF-10	PF-20
2'	1.7	2.6
4'	.31	.57
6'	.10	.13
8'	.04	.05
10'	.02	.03
12'	.01	.02
14'		.01

For conversion to lumens: Multiply footcandles x 10. See FX glossary for a full description of fc and lumens.

FX | LUMINAIRE®
PV-10



PERFECT, MID-SIZED LUMINAIRE

Whether your view is of Monaco, Miami or Monterey, the FX copper pathlites are the best choice for high-end residential and intimate resort projects. The PV is our mid-sized model designed for small scale garden pathways and planters. Choose between the high output / high efficiency halogen lamp or the extended life xenon lamp.

The most successful gardens are a harmonious blend of organic materials. The FX copper line is the perfect match to wood, masonry, and plant materials since the natural patina process allows each fixture to melt into its background.

Compare FX copper luminaires with any other, and you will find a dramatic difference in quality of materials, precision of fit and consistency of finish.

The copper will patina naturally over time and can be accelerated with solution spray. For patina formulas visit our website at: www.FXL.com/learning/patina.htm



WHY USE PATHLIGHTING?

The most visible source of lighting equipment comes from Pathlights. Pathlighting should be used to draw attention to pedestrian hazards such as grade changes or to illuminate surfaces that can't be reached by downlighting from trees, eaves and other architectural elements or integral wall mounted fixtures.

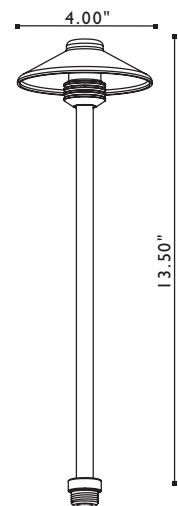

PIATTINO VESTITO® – ORDERING INFORMATION

The PV comes standard with a 10 watt Xenon G4 lamp, Super Slot Spike®, and in Copper (CU).

STANDARD OPTIONS:

1 + 2 + 3 + 4 ORDERED TOGETHER ON SAME LINE

AVAILABLE LAMP CONFIGURATIONS:

Your choice of one lamp will come pre-installed.

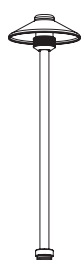
FIXTURE/CODE	WATTAGE/CODE	AVG. LIFE HOUR
1 	2 XENON LAMP OPTIONS:	
	10	10,000
	HALOGEN (H) LAMP OPTIONS:	
	10H	2000

STANDARD RISER OPTIONS:

Your choice of one riser option will come pre-assembled.

Riser Specs: Copper 0.5" Diameter

CODE	DESCRIPTION
3 	8R 8" Riser
	12R 12" Riser
	18R 18" Riser

STANDARD FINISH OPTIONS:

Copper is standard. All other choices must be specified.

CODE	DESCRIPTION
CU 	Copper (will naturally patina)

NON-STOCKING FINISH OPTIONS:

Allow extra time for the following finish options:

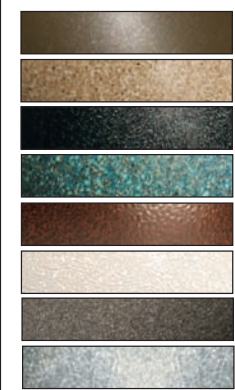
CODE	DESCRIPTION
4 	BZ Bronze Metallic
	DG Desert Granite
	BF Black Wrinkle
	VF Verde Speckle
	SB Sedona Brown
	WF White Wrinkle
	WI Weathered Iron
	NP Nickel Plate

STANDARD PARTS:



ORDERING SAMPLE:

SECTIONS:	DESCRIPTION:	WHAT TO ORDER:
1 + 2 + 3 + 4 <small>optional</small>		=PV-10-12R
A	PostMount®	= PM

NON-STANDARD OPTIONS:

MUST BE ORDERED ON SEPARATE LINE!

ADDITIONAL MOUNTING OPTIONS:

Comes pre-assembled with Super Slot Spike®.

All other mounting options will arrive in separate box.

CODE	DESCRIPTION	SIZE
A 	CDS CapannaDiNoce®	2.00" x 10.00"
	SJ SuperJ-boX®	2.50" x 12.00"
	PM PostMount®	2.50" x 13.00"

PHOTOMETRICS:

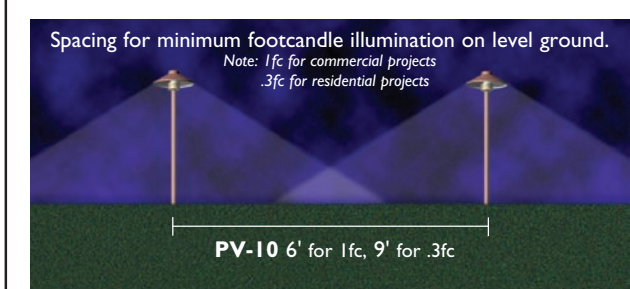

Distance	Footcandle Power (12R riser)		
	PV-10	PV-20	
14'			
12'	2'	1.7	2.6
10'	4'	.31	.57
8'	6'	.10	.13
6'	8'	.04	.05
4'	10'	.02	.03
2'	12'	.01	.02
	14'		.01

For conversion to lumens: Multiply footcandles x 10. See FX glossary for a full description of fc and lumens.

FX | LUMINAIRE®
DL-10, DL-15, DL-20



**INVESTMENT QUALITY
 LIGHTING INSTRUMENT**

Milled from extra heavy gauge copper and brass this petite luminaire is engineered to survive. Whether you're specifying for a resort in Carmel or a backyard in Dallas, the simple geometry of the patent pending DemiLite blends into the environment effortlessly.

The beam spread of the DL provides maximum projection with minimum glare, thereby producing a soft glare-free light up to 28' in diameter!

This model is perfect for coastal exposures or areas where irrigation water contains high levels of mineral or caustic salts.

The copper will patina naturally over time and can be accelerated with solution spray. For patina formulas visit our website at: www.FXL.com/learning/patina.htm

DEMILITE® | FX LUMINAIRE®



**THE TIMELESS BEAUTY
 OF COPPER**

When engineering a new powdercoat finish at FX we strive to make it appear organic so it blends into the surrounding environment. No powdercoat will ever look as natural as copper since it does not develop an uneven mottled finish that consists of the full spectrum of earthtones. Although we ship the copper pathlites in a bright condition they will quickly tarnish to a penny brown, moss-green brown or a blue-green (by the ocean).

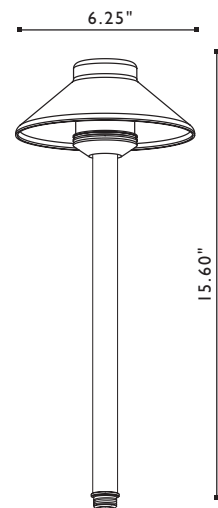

DEMI LITE® - ORDERING INFORMATION

The DL comes standard with a 20 watt Xenon G4 lamp, CapannaDiNoce® (CDS), and in Copper (CU).

STANDARD OPTIONS:
1 + 2 + 3 + 4 ORDERED TOGETHER ON SAME LINE

AVAILABLE LAMP CONFIGURATIONS:
Your choice of one lamp will come pre-installed.

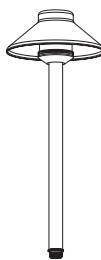
FIXTURE/CODE	WATTAGE/CODE	AVG. LIFE HOUR
	2 XENON LAMP OPTIONS:	
	10	10,000
	15	10,000
	20	5000
	HALOGEN (H) LAMP OPTIONS:	
	10H	2000
	20H	2000

STANDARD RISER OPTIONS:
Your choice of one riser option will come pre-assembled.
Riser Specs: Copper 0.75" Diameter

CODE	DESCRIPTION
	3 8R 8" Riser
	12R 12" Riser
	18R 18" Riser

STANDARD FINISH OPTIONS:
Copper is standard. All other choices must be specified.

CODE	DESCRIPTION
	CU Copper <i>(will naturally patina)</i>

NON-STOCKING FINISH OPTIONS:
Allow extra time for the following finish options:

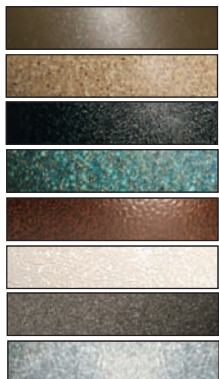
	4 BZ	Bronze Metallic
	DG	Desert Granite
	BF	Black Wrinkle
	VF	Verde Speckle
	SB	Sedona Brown
	WF	White Wrinkle
	WI	Weathered Iron
	NP	Nickel Plate

STANDARD PARTS:



ORDERING SAMPLE:

SECTIONS:	DESCRIPTION:	WHAT TO ORDER:
1 + 2 + 3 + 4 <small>optional</small>	 +  +  + 	= DL-20-12R
A	PostMount®	= PM

NON-STANDARD OPTIONS:
MUST BE ORDERED ON SEPARATE LINE!

ADDITIONAL MOUNTING OPTIONS:

Comes pre-assembled with CapannaDiNoce®.
All other mounting options will arrive in separate box.

CODE	DESCRIPTION	SIZE
	A SJ SuperJ-boX®	2.50" x 12.00"
	PM PostMount®	2.50" x 13.00"

PHOTOMETRICS:

Spacing for minimum footcandle illumination on level ground.
*Note: 1fc for commercial projects
.3fc for residential projects*

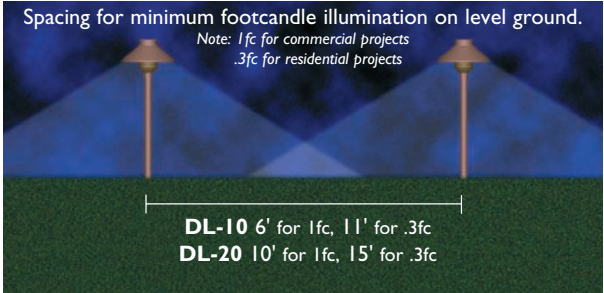

DL-10 6' for 1fc, 11' for .3fc
DL-20 10' for 1fc, 15' for .3fc

Distance	Footcandle Power (12R riser)	
	DL-10	DL-20
2'	1.5	3
4'	.31	.88
6'	.14	.33
8'	.08	.14
10'	.03	.08
12'	.01	.03
14'		.01

For conversion to lumens: Multiply footcandles x 10. See FX glossary for a full description of fc and lumens.

FX | LUMINAIRE®
AN-10, AN-15, AN-20



ARTISTANUOVO® | FX LUMINAIRE®

MOST TALENTED
LIGHTING PERFORMANCE

We have extended our pathlite family with the new Artista Nuovo® (AN). It is the newest addition to our grande family. Similar to the DL in size and shape, the AN has a smooth, all copper top, finish, while the DL has a sharp and stylish brass top.

Milled from extra heavy gauge copper and brass this petite luminaire is engineered to survive. This model is perfect for coastal exposures or areas where irrigation water contains high levels of mineral or caustic salts.

The copper will patina naturally over time and can be accelerated with solution spray. For patina formulas visit our website at: www.FXL.com/learning/patina.htm



THE TIMELESS BEAUTY
OF COPPER

When engineering a new powdercoat finish at FX we strive to make it appear organic so it blends into the surrounding environment. No powdercoat will ever look as natural as copper since it does not develop an uneven mottled finish that consists of the full spectrum of earthtones. Although we ship the copper pathlites in a bright condition they will quickly tarnish to a penny brown, moss-green brown or a blue-green (by the ocean).

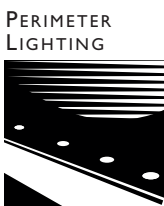
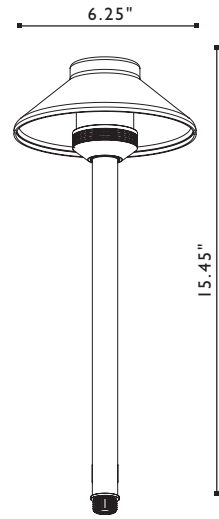

ARTISTANUOVO® – ORDERING INFORMATION

The AN comes standard with a 20 watt Xenon G4 lamp, CapannaDiNoce® (CDS), and in Copper (CU).

STANDARD OPTIONS:

1 + 2 + 3 + 4 ORDERED TOGETHER ON SAME LINE

AVAILABLE LAMP CONFIGURATIONS:

Your choice of one lamp will come pre-installed.

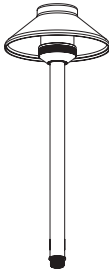
FIXTURE/CODE	WATTAGE/CODE	AVG. LIFE HOUR
	2 XENON LAMP OPTIONS:	
	10	10,000
	15	10,000
	20	5000
	HALOGEN (H) LAMP OPTIONS:	
	10H	2000
	20H	2000

STANDARD RISER OPTIONS:

Your choice of one riser option will come pre-assembled.

Riser Specs: Copper 0.75" Diameter

CODE	DESCRIPTION
	3 8R 8" Riser
	12R 12" Riser
	18R 18" Riser

STANDARD FINISH OPTIONS:

Copper is standard. All other choices must be specified.

CODE	DESCRIPTION
	CU Copper <i>(will naturally patina)</i>

NON-STOCKING FINISH OPTIONS:



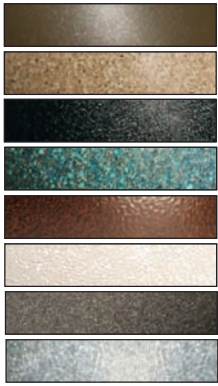

Allow extra time for the following finish options:

	4 BZ Bronze Metallic
	DG Desert Granite
	BF Black Wrinkle
	VF Verde Speckle
	SB Sedona Brown
	WF White Wrinkle
	WI Weathered Iron
	NP Nickel Plate

STANDARD PARTS:



ORDERING SAMPLE:

SECTIONS:	DESCRIPTION:	WHAT TO ORDER:
1 + 2 + 3 + 4 <small>optional</small>	 +  +  + 	= AN-20-12R
A and/or B	PostMount®	= PM
	26' Lead Wire	= 26

NON-STANDARD OPTIONS:

MUST BE ORDERED ON SEPARATE LINE!

ADDITIONAL MOUNTING OPTIONS:

Comes pre-assembled with CapannaDiNoce®.

All other mounting options will arrive in separate box.

CODE	DESCRIPTION	SIZE
	A SJ SuperJ-boX®	2.50" x 12.00"
	PM PostMount®	2.50" x 13.00"

ADDITIONAL LEAD WIRE OPTIONS:

Fixture comes standard with a 34" (.9m) lead wire

	B 26	26' Lead Wire
--------------------------------------------------------------------------------------	--------------------	---------------

Note: The 26' lead wire will come at an additional cost.

FX | LUMINAIRE®
DM-10, DM-15, DM-20



CLASSIC LINES, TIMELESS CONSTRUCTION

For those who appreciate the best, this pathway light is designed for both high performance and style. The strong, linear lines of the DelMare® will complement any landscape by day and bring it to life at night.

This patent pending luminaire is the best choice for the client who wants a flawless design that will make a long term contribution to their garden. Using high output long life halogen lamps reduces operating and service costs.

All FX copper models are well suited for coastal exposures or areas where irrigation water contains high levels of mineral or caustic salts.

The copper will patina naturally over time and can be accelerated with solution spray. For patina formulas visit our website at: www.FXL.com/learning/patina.htm

DELMARE® | FX LUMINAIRE®



THE HARMONY OF PATINA

The most successful gardens are a harmonious blend of organic materials. The FX copper line is the perfect match to wood, masonry, and plant materials since the natural patina process allows each fixture to melt into its backgrounds.

Compare FX copper luminaires with any other, and you will find a dramatic difference in quality of materials, precision of fit and consistency of finish.

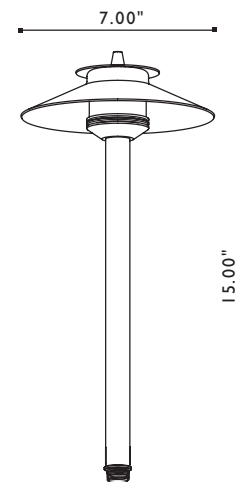

DEL MARE® – ORDERING INFORMATION

The DM comes standard with a 20 watt Xenon G4 lamp, CapannaDiNoce® (CDS), and in Copper (CU).

STANDARD OPTIONS:

1 + 2 + 3 + 4 ORDERED TOGETHER ON SAME LINE

AVAILABLE LAMP CONFIGURATIONS:

Your choice of one lamp will come pre-installed.

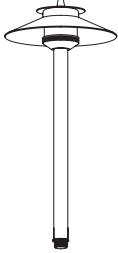
FIXTURE/CODE	WATTAGE/CODE	AVG. LIFE HOUR
1 	2 XENON LAMP OPTIONS:	
	10	10,000
	15	10,000
	20	5000
	HALOGEN (H) LAMP OPTIONS:	
	10H	2000
	20H	2000

STANDARD RISER OPTIONS:

Your choice of one riser option will come pre-assembled.

Riser Specs: Copper 0.75" Diameter

	CODE	DESCRIPTION
	3 8R	8" Riser
	12R	12" Riser
	18R	18" Riser







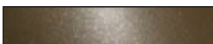

STANDARD FINISH OPTIONS:

Copper is standard. All other choices must be specified.

	CODE	DESCRIPTION
	CU	Copper (will naturally patina)

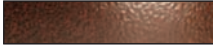
NON-STOCKING FINISH OPTIONS:

Allow extra time for the following finish options:

	CODE	DESCRIPTION
	4 BZ	Bronze Metallic
	DG	Desert Granite
	BF	Black Wrinkle
	VF	Verde Speckle
	SB	Sedona Brown
	WF	White Wrinkle
	WI	Weathered Iron
	NP	Nickel Plate

STANDARD PARTS:



ORDERING SAMPLE:

SECTIONS:	DESCRIPTION:	WHAT TO ORDER:
1 + 2 + 3 + 4 <small>optional</small>		= DM-20-12R
A	PostMount®	= PM

NON-STANDARD OPTIONS:

MUST BE ORDERED ON SEPARATE LINE!

ADDITIONAL MOUNTING OPTIONS:

Comes pre-assembled with CapannaDiNoce®.

All other mounting options will arrive in separate box.

	CODE	DESCRIPTION	SIZE
	A SJ	SuperJ-boX®	2.50" x 12.00"
	PM	PostMount®	2.50" x 13.00"

PHOTOMETRICS:

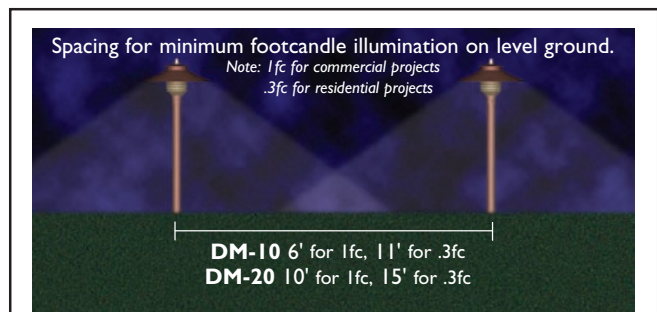

Distance	Footcandle Power (12R riser)		
	DM-10	DM-20	
14'			
12'	2'	1.45	2.9
10'	4'	.30	.86
	6'	.13	.31
	8'	.09	.11
6'	10'	.3	.07
	12'	.01	.03
4'	14'		.01
2'			

For conversion to lumens: Multiply footcandles x 10. See FX glossary for a full description of fc and lumens.

FX | LUMINAIRE®
CB-10, CB-15, CB-20



CAPELLIBIONDI® | FX LUMINAIRE®

SIMPLE, ELEGANT, ELITE
 The introduction of the CB to any landscape will be a welcome one. Its sophisticated styling and first class quality will add new dimension to any fine landscape. It is no secret why our pathlites are easy to distinguish from the rest.

This luminaire is the best choice for the client who wants a flawless design that will make a long term contribution to their garden.

Milled from very heavy gauge, solid copper with stainless hardware, this luminaire will enhance any fine lighting project.

The copper will patina naturally over time and can be accelerated with solution spray – for patina formula visit our website at: www.FXL.com/learning/patina.htm



CAPTURE THE NIGHT
 Gardens are extension of our homes, therefore you should be able to enjoy them all the time- not just during the daylight hours. It is important to illuminate these spaces, while respecting the surrounding nature. Artificial lighting shouldn't be distracting, but should make your space look and feel romantic. FX's organic designs integrate themselves effortlessly into their surroundings. Dazzle your rows of blooms with a CapelliBiondi, bringing focus to your garden while distracting the eye from other undesirable elements.

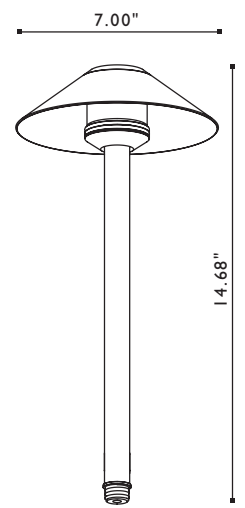

CAPELLIBIONDI® – ORDERING INFORMATION

The CB comes standard with a 20 watt Xenon G4 lamp, CapannaDiNoce® (CDS), and in Copper (CU).

STANDARD OPTIONS:

1 + 2 + 3 + 4 ORDERED TOGETHER ON SAME LINE

AVAILABLE LAMP CONFIGURATIONS:

Your choice of one lamp will come pre-installed.

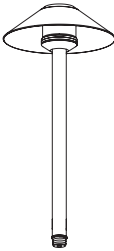
FIXTURE/CODE	WATTAGE/CODE	AVG. LIFE HOUR
1 CB 	2 XENON LAMP OPTIONS:	
	10	10,000
	15	10,000
	20	5000
	HALOGEN (H) LAMP OPTIONS:	
	10H	2000
	20H	2000

STANDARD RISER OPTIONS:

Your choice of one riser option will come pre-assembled.

Riser Specs: Copper 0.75" Diameter

	CODE	DESCRIPTION
	3 8R	8" Riser
	12R	12" Riser
	18R	18" Riser

STANDARD FINISH OPTIONS:

Copper is standard. All other choices must be specified.

	CODE	DESCRIPTION
	CU	Copper (will naturally patina)

NON-STOCKING FINISH OPTIONS:

Allow extra time for the following finish options:

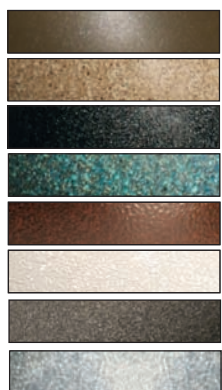
	CODE	DESCRIPTION
	4 BZ	Bronze Metallic
	DG	Desert Granite
	BF	Black Wrinkle
	VF	Verde Speckle
	SB	Sedona Brown
	WF	White Wrinkle
	WI	Weathered Iron
	NP	Nickel Plate

STANDARD PARTS:



ORDERING SAMPLE:

SECTIONS:	DESCRIPTION:	WHAT TO ORDER:
1 + 2 + 3 + 4 <small>optional</small>		= CB-20-12R
A	PostMount®	= PM

NON-STANDARD OPTIONS:

MUST BE ORDERED ON SEPARATE LINE!

ADDITIONAL MOUNTING OPTIONS:

Comes pre-assembled with CapannaDiNoce®.

All other mounting options will arrive in separate box.

	CODE	DESCRIPTION	SIZE
	A SJ	SuperJ-boX®	2.50" x 12.00"
	PM	PostMount®	2.50" x 13.00"

PHOTOMETRICS:

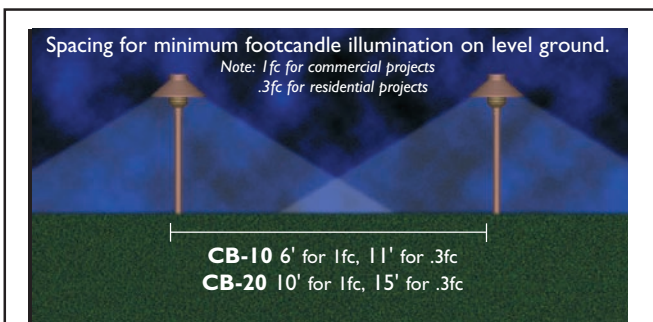

	Footcandle Power (12R riser)		
	Distance	CB-10	CB-20
14'			
12'	2'	1.5	3
10'	4'	.31	.88
8'	6'	.14	.33
6'	8'	.08	.14
4'	10'	.03	.08
2'	12'	.01	.03
	14'		.01

For conversion to lumens: Multiply footcandles x 10. See FX glossary for a full description of fc and lumens.

FX | LUMINAIRE®
CA-10, CA-15, CA-20



CRESCENTEALBA® | FX LUMINAIRE®

MUSEUM QUALITY,
PRECISION ENGINEERED

The beauty of the CA is not just its uncomplicated shape, but its top-notch performance, night after night. For those who demand excellence, this luminaire will satisfy all that is required of it and more.

The key to successful outdoor lighting is to incorporate the equipment into the structures or garden without introducing a conflicting design element. The CA's simple geometric form allows it to disappear into any fine trellis or arbor.

Compare FX copper luminaires with any other, you will find a dramatic difference in quality of materials, precision of fit and consistency of finish.

The copper will patina naturally over time and can be accelerated with solution spray – for patina formula visit our website at: www.FXL.com/learning/patina.htm



CREATE ARTISTIC EFFECTS

With landscape lighting, you have the ability to create moon-like shadows dance on the ground, or simply use a diffused glow to make a path safer. Use lighting effects to create soft transitions to the darkness beyond. Pathlights help focus the eye on the surroundings, while enhancing the textures of plants and walkways making the space inviting. Create artistic landscape installations with the additional of any copper pathlite.

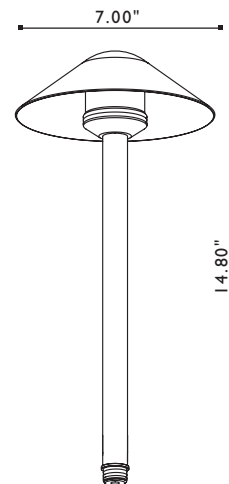

PERIMETER
LIGHTING



CRESCENTEALBA® – ORDERING INFORMATION

The CA comes standard with a 20 watt Xenon G4 lamp, CapannaDiNoce® (CDS), and in Copper (CU).

STANDARD OPTIONS:

1 + 2 + 3 + 4 ORDERED TOGETHER ON SAME LINE

AVAILABLE LAMP CONFIGURATIONS:

Your choice of one lamp will come pre-installed.

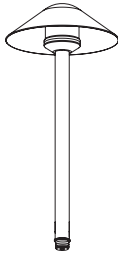
FIXTURE/CODE	WATTAGE/CODE	AVG. LIFE HOUR
1 CA 	2 XENON LAMP OPTIONS:	
	10	10,000
	15	10,000
	20	5000
	HALOGEN (H) LAMP OPTIONS:	
	10H	2000
	20H	2000

STANDARD RISER OPTIONS:

Your choice of one riser option will come pre-assembled.

Riser Specs: Copper 0.75" Diameter

	CODE	DESCRIPTION
	3 8R	8" Riser
	12R	12" Riser
	18R	18" Riser

STANDARD FINISH OPTIONS:

Copper is standard. All other choices must be specified.

	CODE	DESCRIPTION
	CU	Copper (will naturally patina)

NON-STOCKING FINISH OPTIONS:

Allow extra time for the following finish options:

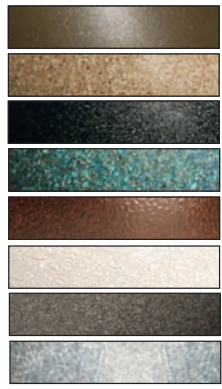
	CODE	DESCRIPTION
	4 BZ	Bronze Metallic
	DG	Desert Granite
	BF	Black Wrinkle
	VF	Verde Speckle
	SB	Sedona Brown
	WF	White Wrinkle
	WI	Weathered Iron
	NP	Nickel Plate

STANDARD PARTS:



ORDERING SAMPLE:

SECTIONS:	DESCRIPTION:	WHAT TO ORDER:
1 + 2 + 3 + 4 <small>optional</small>		= CA-20-12R
A	PostMount®	= PM

NON-STANDARD OPTIONS:

MUST BE ORDERED ON SEPARATE LINE!

ADDITIONAL MOUNTING OPTIONS:

Comes pre-assembled with CapannaDiNoce®.

All other mounting options will arrive in separate box.

	CODE	DESCRIPTION	SIZE
	A SJ	SuperJ-boX®	2.50" x 12.00"
	PM	PostMount®	2.50" x 13.00"

PHOTOMETRICS:

Spacing for minimum footcandle illumination on level ground.
 Note: 1fc for commercial projects
 .3fc for residential projects

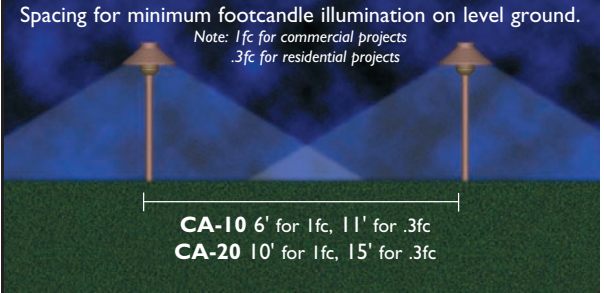

CA-10 6' for 1fc, 11' for .3fc
 CA-20 10' for 1fc, 15' for .3fc

Footcandle Power (12R riser)			
Distance	CA-10	CA-20	
2'	1.5	3	
4'	.31	.88	
6'	.14	.33	
8'	.08	.14	
10'	.03	.08	
12'	.01	.03	
14'		.01	

For conversion to lumens: Multiply footcandles x 10. See FX glossary for a full description of fc and lumens.

FX | LUMINAIRE®
CV-10, CV-15, CV-20



**MODERN, DEPENDABLE,
EFFECTIVE**

The unforgettable shape of the CV is sure to make statement. You'll delight in its form, but admire its strength and function. It is just another noteworthy addition to our already superior line of pathlites.

Milled from extra-heavy gauge copper and solid brass, the patent pending CV is engineered to survive.

All FX copper models are well suited for coastal exposures or areas where irrigation water contains high levels of mineral or caustic salts.

The copper will patina naturally over time and can be accelerated with solution spray – for patina formula visit our website at: www.FXL.com/learning/patina.htm

CAPOLAVORO® | FX LUMINAIRE®



LONG-LASTING QUALITY

Brass and copper have been used for a thousand years in nautical applications. Naval architects understood and explained the high strength and natural corrosion resistance of these semi-precious metals. The garden environment is as tough and caustic as any found in the high seas.

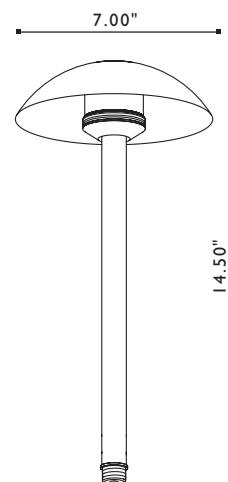

CAPOLAVORO® – ORDERING INFORMATION

The CV comes standard with a 20 watt Xenon G4 lamp, CapannaDiNoce® (CDS), and in Copper (CU).

STANDARD OPTIONS:

1 + 2 + 3 + 4 ORDERED TOGETHER ON SAME LINE

AVAILABLE LAMP CONFIGURATIONS:

Your choice of one lamp will come pre-installed.

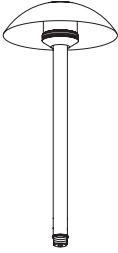
FIXTURE/CODE	WATTAGE/CODE	AVG. LIFE HOUR
1 CV 	2 XENON LAMP OPTIONS:	
	10	10,000
	15	10,000
	20	5000
	HALOGEN (H) LAMP OPTIONS:	
	10H	2000
	20H	2000

STANDARD RISER OPTIONS:

Your choice of one riser option will come pre-assembled.

Riser Specs: Copper 0.75" Diameter

	CODE	DESCRIPTION
3 	8R	8" Riser
	12R	12" Riser
	18R	18" Riser

STANDARD FINISH OPTIONS:

Copper is standard. All other choices must be specified.

	CODE	DESCRIPTION
	CU	Copper (will naturally patina)

NON-STOCKING FINISH OPTIONS:

Allow extra time for the following finish options:

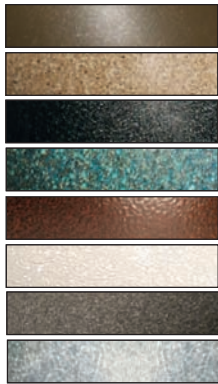
	CODE	DESCRIPTION
4 	BZ	Bronze Metallic
	DG	Desert Granite
	BF	Black Wrinkle
	VF	Verde Speckle
	SB	Sedona Brown
	WF	White Wrinkle
	WI	Weathered Iron
	NP	Nickel Plate

STANDARD PARTS:



ORDERING SAMPLE:

SECTIONS:	DESCRIPTION:	WHAT TO ORDER:
1 + 2 + 3 + 4 <small>optional</small>		= CV-20-12R
A	PostMount®	= PM

NON-STANDARD OPTIONS:

MUST BE ORDERED ON SEPARATE LINE!

ADDITIONAL MOUNTING OPTIONS:

Comes pre-assembled with CapannaDiNoce®.

All other mounting options will arrive in separate box.

	CODE	DESCRIPTION	SIZE
	A		
	SJ	SuperJ-boX®	2.50" x 12.00"
	PM	PostMount®	2.50" x 13.00"

PHOTOMETRICS:

Spacing for minimum footcandle illumination on level ground.
 Note: 1fc for commercial projects
 .3fc for residential projects

CV-10 6' for 1fc, 11' for .3fc
 CV-20 10' for 1fc, 15' for .3fc

Distance	Footcandle Power (12R riser)	
	CV-10	CV-20
2'	1.5	3
4'	.31	.88
6'	.14	.33
8'	.08	.14
10'	.03	.08
12'	.01	.03
14'		.01

For conversion to lumens: Multiply footcandles x 10. See FX glossary for a full description of fc and lumens.

FX | LUMINAIRE®
QF-10, QF-15, QF-20



QUADRATOFIDATO® | FX LUMINAIRE®

**DISTINGUISHED DESIGN,
 EXCEPTIONAL PERFORMANCE**

Personalize your landscape with the unique design of the QF. This original luminaire, with its precise angles, will add a new dimension to your landscape. It is where style meets unmatched performance.

The high output, long-life Xenolux® lamp assembly reduces operating and maintenance costs.

All FX copper models are well suited for coastal exposures or areas where irrigation water contains high levels of mineral or caustic salts.

The copper will patina naturally over time and can be accelerated with solution spray – for patina formula visit our website at: www.FXL.com/learning/patina.htm



PERFECTION EVERY TIME

When thinking outdoor lighting- you should think permanence. Candles are nice and inexpensive, but only landscape lighting can provide safety. Precision placed lighting can reinforce the feeling of intimacy and warmth. The ways to create a wonderful outdoor space are infinite. You no longer have to use a flood light to overpower the space with light.

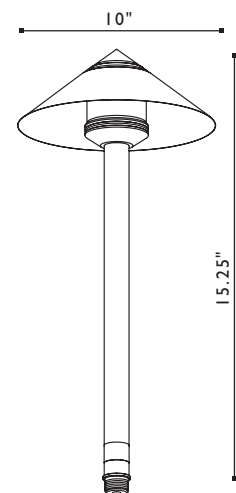

QUADRATOFIDATO® - ORDERING INFORMATION

The QF comes standard with a 20 watt Xenon G4 lamp, CapannaDiNoce® (CDS), and in Copper (CU).

STANDARD OPTIONS:

1 + 2 + 3 + 4 ORDERED TOGETHER ON SAME LINE

AVAILABLE LAMP CONFIGURATIONS:

Your choice of one lamp will come pre-installed.

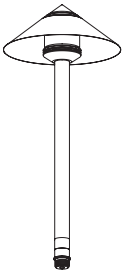
FIXTURE/CODE	WATTAGE/CODE	AVG. LIFE HOUR
1 QF 	2 XENON LAMP OPTIONS:	
	10	10,000
	15	10,000
	20	5000
	HALOGEN (H) LAMP OPTIONS:	
	10H	2000
	20H	2000

STANDARD RISER OPTIONS:

Your choice of one riser option will come pre-assembled.

Riser Specs: Copper 0.75" Diameter

CODE	DESCRIPTION
3 	8R 8" Riser
	12R 12" Riser
	18R 18" Riser







STANDARD FINISH OPTIONS:

Copper is standard. All other choices must be specified.

CODE	DESCRIPTION
CU	Copper (will naturally patina)

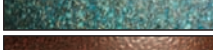
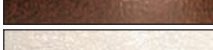
NON-STOCKING FINISH OPTIONS:

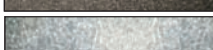
Allow extra time for the following finish options:

	4 BZ	Bronze Metallic
	DG	Desert Granite
	BF	Black Wrinkle
	VF	Verde Speckle
	SB	Sedona Brown
	WF	White Wrinkle
	WI	Weathered Iron
	NP	Nickel Plate

STANDARD PARTS:



ORDERING SAMPLE:

SECTIONS:	DESCRIPTION:	WHAT TO ORDER:
1 + 2 + 3 + 4 <small>optional</small>		= QF-20-12R
A	PostMount®	= PM

NON-STANDARD OPTIONS:

MUST BE ORDERED ON SEPARATE LINE!

ADDITIONAL MOUNTING OPTIONS:

Comes pre-assembled with CapannaDiNoce®.

All other mounting options will arrive in separate box.

CODE	DESCRIPTION	SIZE
A 	SJ SuperJ-boX®	2.50" x 12.00"
	PM PostMount®	2.50" x 13.00"

PHOTOMETRICS:

Spacing for minimum footcandle illumination on level ground.
 Note: 1fc for commercial projects
 .3fc for residential projects

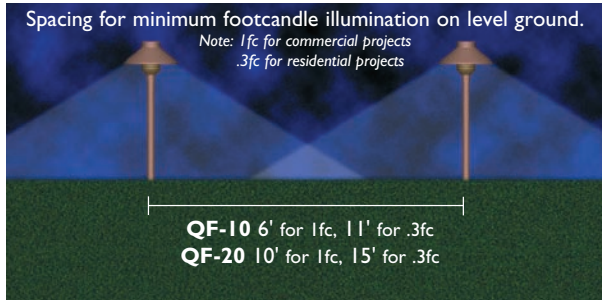

QF-10 6' for 1fc, 11' for .3fc
QF-20 10' for 1fc, 15' for .3fc

Footcandle Power (12R riser)			
Distance	QF-10	QF-20	
2'	1.5	3	
4'	.31	.88	
6'	.14	.33	
8'	.08	.14	
10'	.03	.08	
12'	.01	.03	
14'		.01	

For conversion to lumens: Multiply footcandles x 10. See FX glossary for a full description of fc and lumens.

FX | LUMINAIRE®
GN-20



GRANDEZZA NATURALE® | FX LUMINAIRE®

FOR THE MOST
DISCRIMINATING OWNER

Make a statement with the GN- the granddaddy of the DelMare. The GN has the same elegant styling of the DM, but it is bigger and bolder. With a diameter of 10", this oversized pathlite is sure to fit any large scale estate.

This geometrically perfect design is best used in focal color planter beds to bring the nighttime garden to life with its warm symmetrical circular pool of light.

At FX, we engineer fixtures from the inside out. Our use of semi precious metals, aerospace sealants and materials is without peer. This commitment to excellence provides your client with decades of problem-free ownership.

The copper will patina naturally over time and can be accelerated with solution spray – for patina formula visit our website at: www.FXL.com/learning/patina.htm



PERFECTION IN COPPER

Milled from solid copper, the GN is engineered to make a long term contribution to any fine project. Compare FX copper pathlites with any other, you will find a dramatic difference in quality of materials, precision of fit and consistency of finish.

A powdercoat will never look as natural as copper since it does not develop an uneven mottled finish that consists of the full spectrum of earthtones.

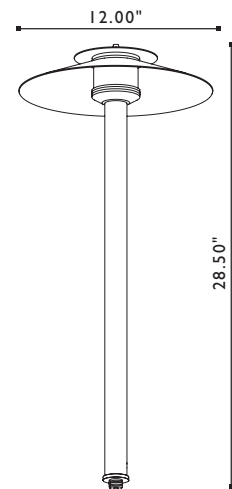

PERIMETER
LIGHTING

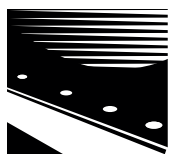

GRANDEZZANATURALE® – ORDERING INFORMATION

The GN comes standard with a 20 watt Xenon G4 lamp, CapannaDiNoce® (CDS), and in Copper (CU).

STANDARD OPTIONS:

1 + 2 + 3 + 4 ORDERED TOGETHER ON SAME LINE

AVAILABLE LAMP CONFIGURATIONS:

Your choice of one lamp will come pre-installed.

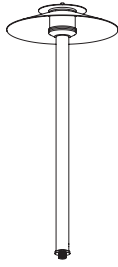
FIXTURE/CODE	WATTAGE/CODE	AVG. LIFE HOUR
1 GN 	2 XENON LAMP OPTIONS: 20 5000	
	HALOGEN LAMP OPTIONS: 35H 2000	

STANDARD RISER OPTIONS:

Your choice of one riser option will come pre-assembled.

Riser Diameter: Copper 1.25" Diameter

CODE	DESCRIPTION
3 	18R 18" Riser
	24R 24" Riser

STANDARD FINISH OPTIONS:

Copper is standard. All other choices must be specified.

CODE	DESCRIPTION
CU	Copper (will naturally patina)

NON-STOCKING FINISH OPTIONS:

Allow extra time for the following finish options:

CODE	DESCRIPTION
4 BZ	Bronze Metallic
DG	Desert Granite
BF	Black Wrinkle
VF	Verde Speckle
SB	Sedona Brown
WF	White Wrinkle
WI	Weathered Iron
NP	Nickel Plate

STANDARD PARTS:



ORDERING SAMPLE:

SECTIONS:	DESCRIPTION:	WHAT TO ORDER:
1 + 2 + 3 + 4 <small>optional</small>		= GN-20-18R
A	PostMount®	= PM

NON-STANDARD OPTIONS:

MUST BE ORDERED ON SEPARATE LINE!

ADDITIONAL MOUNTING OPTIONS:

Comes pre-assembled with CapannaDiNoce®.

All other mounting options will arrive in separate box.

CODE	DESCRIPTION	SIZE
A 	SJ SuperJ-boX®	2.50" x 12.00"
	PM PostMount®	2.50" x 13.00"

PHOTOMETRICS:

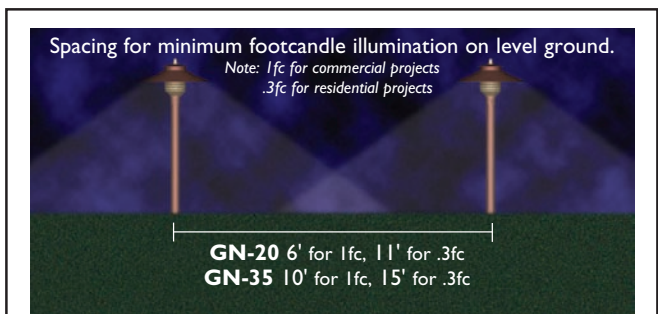

Distance	Footcandle Power (12R riser)	
	GN-20	GN-35
2'	1.45	2.9
4'	.30	.86
6'	.13	.31
8'	.09	.11
10'	.3	.07
12'	.01	.03
14'		.01

For conversion to lumens: Multiply footcandles x 10. See FX glossary for a full description of fc and lumens.

FX | LUMINAIRE®
GT-10, GT-20



GUSCIOTARTARUGA® | FX LUMINAIRE®

ADAPTABLE TO ANY ENVIRONMENT

Unlike any other pathlite, the GT is specially designed to make it adaptable to a wide range of lighting needs. With its ability to adjust to any angle, your favorite path, plant or flower will not be left in the dark. Designed with the user in mind, its aim is to highlight what YOU want, not what your lighting fixture wants.

Use the GT to focus attention to stairs, paths, or garden areas. When combined with the RL, they will partner up to create seamless lighting.

The copper will patina naturally over time and can be accelerated with solution spray. For patina formulas visit our website at: www.FXL.com/learning/patina.htm



FULLY CUSTOMIZABLE

The GT is fully customizable. Pivot the GT down to illuminate desirable features directly below, angle it up to highlight a subject further away, or choose any angle in between for any object in between! Its flexibility is infinite. Perfect for illuminating steps, flower beds or even backyard golf putting greens.

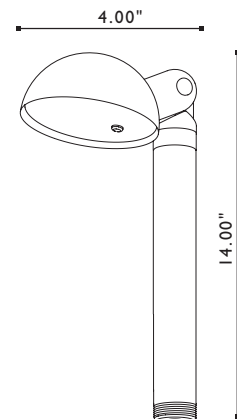

GUSCIOTARTARUGA® – ORDERING INFORMATION

The GT comes standard with a 20 watt Xenon G4 lamp, CapannaDiNoce® (CDS), and in Copper (CU).

STANDARD OPTIONS:

1 + 2 + 3 + 4 ORDERED TOGETHER ON SAME LINE

AVAILABLE LAMP CONFIGURATIONS:

Your choice of one lamp will come pre-installed.

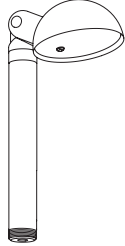
FIXTURE/CODE	WATTAGE/CODE	AVG. LIFE HOUR
1 GT 	2 XENON LAMP OPTIONS:	
	10	10,000
	20	5000
	2 HALOGEN (H) LAMP OPTIONS:	
	10H	2000
	20H	2000
	35H	2000

STANDARD RISER OPTIONS:

Your choice of one riser option will come pre-assembled.

Riser Specs: Copper 1.0" Diameter

	CODE	DESCRIPTION
	3 8R	8" Riser
	12R	12" Riser
	18R	18" Riser







STANDARD FINISH OPTIONS:

Copper is standard. All other choices must be specified.

	CODE	DESCRIPTION
	CU	Copper (will naturally patina)

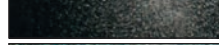
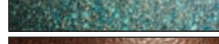
NON-STOCKING FINISH OPTIONS:

Allow extra time for the following finish options:

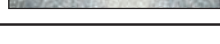
	4 BZ	Bronze Metallic
	DG	Desert Granite
	BF	Black Wrinkle
	VF	Verde Speckle
	SB	Sedona Brown
	WF	White Wrinkle
	WI	Weathered Iron
	NP	Nickel Plate

STANDARD PARTS:



ORDERING SAMPLE:

SECTIONS:	DESCRIPTION:	WHAT TO ORDER:
1 + 2 + 3 + 4 <small>optional</small>		= GT-20-12R
A	PostMount®	= PM

NON-STANDARD OPTIONS:

MUST BE ORDERED ON SEPARATE LINE!

ADDITIONAL MOUNTING OPTIONS:

Comes pre-assembled with CapannaDiNoce®.

All other mounting options will arrive in separate box.

	CODE	DESCRIPTION	SIZE
	A SJ	SuperJ-boX®	2.50" x 12.00"
	PM	PostMount®	2.50" x 13.00"

FX | LUMINAIRE®
FG-12, FG-18, FG-25

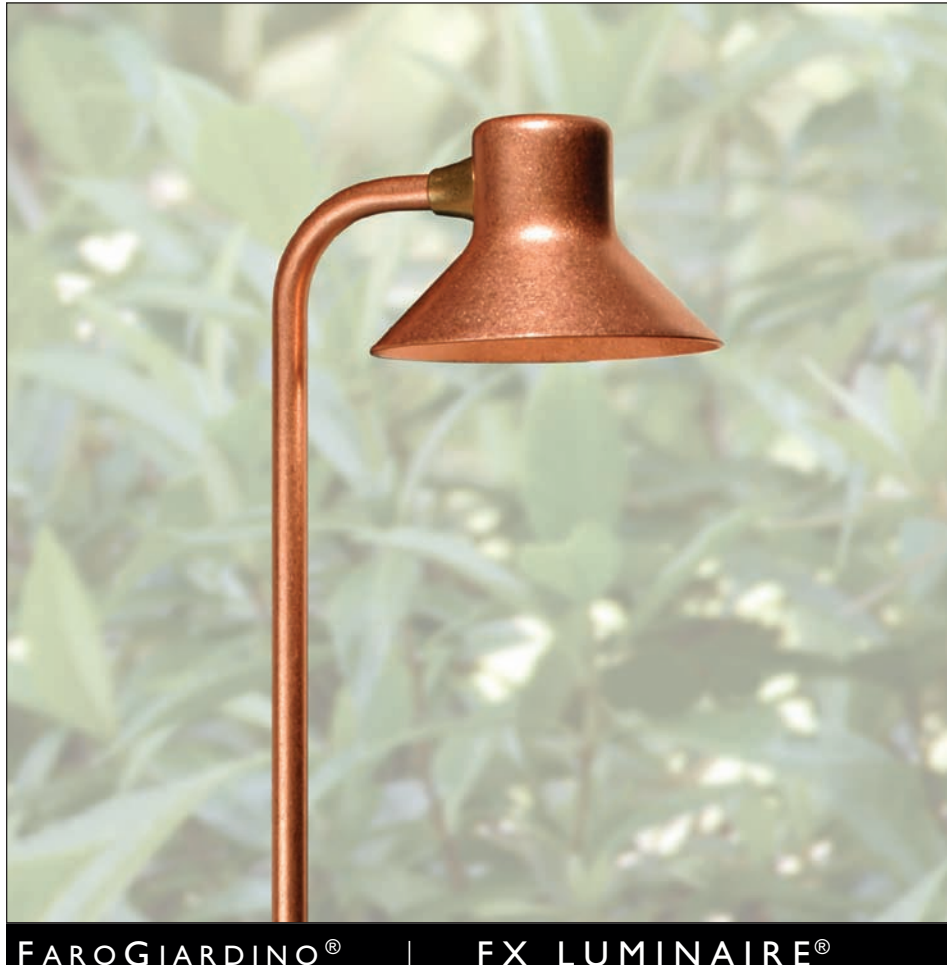

A BEAUTIFUL HARMONY OF BRASS AND COPPER

By day or night the simple lines of the patent pending FaroGiardino® adds elegance and function to any fine residence. Precision milled from solid brass and copper to Ferrari® tolerances, with the clean classic design of a country home, this pathway light transcends momentary style trends.

The design lines of the FG-12 are at home in a wide range of surroundings from craftsman style architectures to tuscan gardens.

This geometrically perfect design is best used in focal color planter beds to bring the nighttime garden to life with its warm symmetrical circular pool of light. Use along pool patio edges, walkways and motor courts.

The copper will patina naturally over time and can be accelerated with solution spray. For patina formulas visit our website at: www.FXL.com/learning/patina.htm

FAROGIARDINO® | FX LUMINAIRE®



SIMPLE ELEGANCE

Lighting should be used to highlight, not overpower. Use it to create boundaries and mystery. Lighting your landscape can be compared to the art of stage lighting. You must know where to strategically place your lighting to create emotion. You can illuminate paths, focus attention on fountains and enhance a gorgeous area of fauna. Different types of lighting can combine to create an intimate scene.

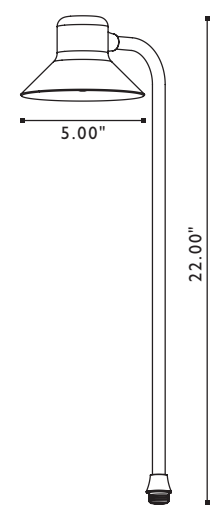

FAROGIARDINO® – ORDERING INFORMATION

The FG comes standard with a Frosted 12 watt Incandescent lamp, CapannaDiNoce® (CDS), and in Copper (CU).

STANDARD OPTIONS:

1 + 2 + 3 ORDERED TOGETHER ON SAME LINE

AVAILABLE LAMP CONFIGURATIONS:

Your choice of one lamp will come pre-installed.

FIXTURE/CODE	WATTAGE/CODE	AVG. LIFE HOUR
1 FG 	2 INCANDESCENT LAMP OPTIONS:	
	12	2000
	18	2000
	25	2000









STANDARD FINISH OPTIONS:

Copper is standard. All other choices must be specified.

CODE	DESCRIPTION
 CU	Copper <i>(will naturally patina)</i>

NON-STOCKING FINISH OPTIONS:

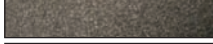
Allow extra time for the following finish options:

	3 BZ	Bronze Metallic
	DG	Desert Granite
	BF	Black Wrinkle
	VF	Verde Speckle
	SB	Sedona Brown
	WF	White Wrinkle
	WI	Weathered Iron
	NP	Nickel Plate

STANDARD PARTS:



ORDERING SAMPLE:

SECTIONS:	DESCRIPTION:	WHAT TO ORDER:
1 + 2 + 3 <small>optional</small>		= FG-12
A	PostMount®	= PM

NON-STANDARD OPTIONS:

MUST BE ORDERED ON SEPARATE LINE!

ADDITIONAL MOUNTING OPTIONS:

Comes pre-assembled with CapannaDiNoce®.

All other mounting options will arrive in separate box.

CODE	DESCRIPTION	SIZE
A SJ	SuperJ-boX®	2.50" x 12.00"
PM	PostMount®	2.50" x 13.00"

PHOTOMETRICS:

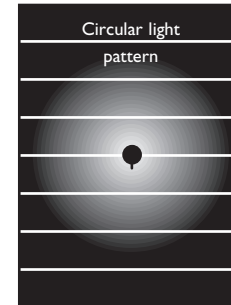
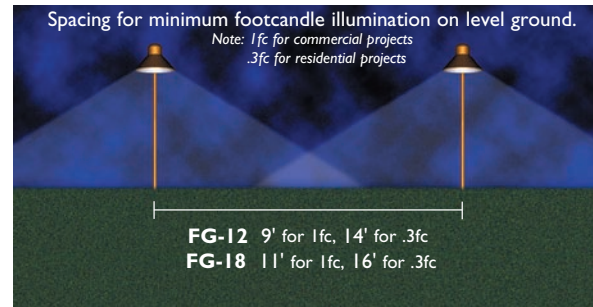

Distance	Footcandle Power	
	FG-12	FG-18
4'	1.2	1.7
6'	.51	.94
8'	.10	.19
10'		.05

For conversion to lumens: Multiply footcandles x 10. See FX glossary for a full description of fc and lumens.

FX | LUMINAIRE®
TD-12, TD-18, TD-25



**ELEGANT LINES,
 SOLID CONSTRUCTION**

By day or night the simple lines of the TulipanoD'oro® (golden tulip) add elegance and function to any fine residence. Precision milled from solid brass and copper to Ferrari® tolerances, with the clean classic design of a country home, this pathway light transcends momentary style trends.

The patent pending TulipanoD'oro® emits a large elliptical light pattern that projects (2') .6m behind the fixture, (16') 4.8m forward and (12') 3.6m wide, but no higher than knee level.

When mounted in lacy leaf plant material, the TD-12 creates a mini-moonlight effect which allows the foliage shadows to dance on the walkway with every pass of an evening breeze.

The copper will patina naturally over time and can be accelerated with solution spray. For patina formulas visit our website at: www.FXL.com/learning/patina.htm

TULIPANOD'ORO® | FX LUMINAIRE®



ONE OF A KIND

Copper will patina in an unlimited array of natural earthtone colors. In the desert a penny brown is common, on the coast a blue or mossy green can occur. No two fixtures will patina the same which gives copper and brass its one-of-a-kind look like any plant or garden element.

Compare FX copper luminaires with any other, and you will find a dramatic difference. We use the heaviest gauge materials in the industry for long-lasting performance.

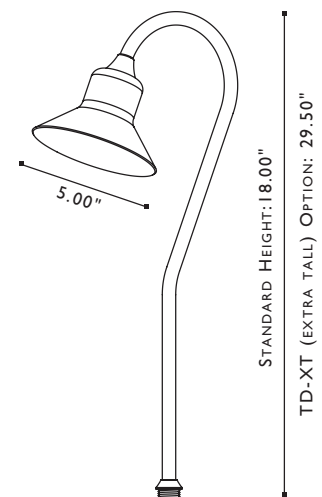

TULIPANO D'ORO® – ORDERING INFORMATION

The TD comes standard with a Frosted 12 watt Incandescent lamp, CapannaDiNoce® (CDS), and in Copper (CU).

STANDARD OPTIONS:

1 + 2 + 3 + 4 ORDERED TOGETHER ON SAME LINE

AVAILABLE LAMP CONFIGURATIONS:

Your choice of one lamp will come pre-installed.

FIXTURE/CODE	WATTAGE/CODE	AVG. LIFE HOUR
1 TD 	2 INCANDESCENT LAMP OPTIONS:	
	12	2000
	18	2000
	25	2000









STANDARD FINISH OPTIONS:

Copper is standard. All other choices must be specified.

CODE	DESCRIPTION
CU	Copper <i>(will naturally patina)</i>

NON-STOCKING FINISH OPTIONS:

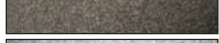
Allow extra time for the following finish options:

	3 BZ	Bronze Metallic
	DG	Desert Granite
	BF	Black Wrinkle
	VF	Verde Speckle
	SB	Sedona Brown
	WF	White Wrinkle
	WI	Weathered Iron
	NP	Nickel Plate

OTHER HEIGHT OPTIONS:

Must be specified if you need the following riser option:

	4 XT	29.50" Tall
-------------------------------------------------------------------------------------	-------------	-------------

STANDARD PARTS:



ORDERING SAMPLE:

SECTIONS:	DESCRIPTION:	WHAT TO ORDER:
1 + 2 + 3 + 4 <small>optional optional</small>	 +  + 	= TD-12
A	PostMount®	= PM

NON-STANDARD OPTIONS:

MUST BE ORDERED ON SEPARATE LINE!

ADDITIONAL MOUNTING OPTIONS:

Comes pre-assembled with CapannaDiNoce®.

All other mounting options will arrive in separate box.

CODE	DESCRIPTION	SIZE
A SJ	SuperJ-boX®	2.50" x 12.00"
PM	PostMount®	2.50" x 13.00"

PHOTOMETRICS:

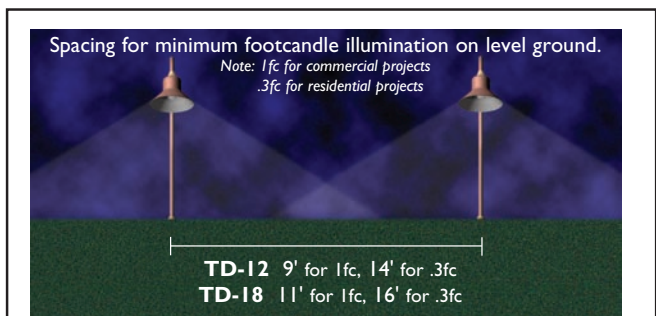

28" Unique elliptical light pattern	Footcandle Power	
	Distance	TD-12
4'	1.2	1.7
6'	.51	.98
8'	.27	.53
10'	.15	.27
12'	.08	.18
14'	.03	.09
16'	.01	.03
18'		.01

For conversion to lumens: Multiply footcandles x 10. See FX glossary for a full description of fc and lumens.

FX | LUMINAIRE®
AL-12, AL-18, AL-25



ACCENTOLUME® | FX LUMINAIRE®

**THE MOST EFFICIENT
 PATHLITE AVAILABLE**

The FX Luminaire® AccentoLume® is a perfect blend of elegant form and clean geometric lines. Designed to blend in effortlessly with both classic and modern architectures by combining graceful appearance with simplicity of form.

The patent pending AccentoLume® is constructed from extremely durable corrosion resistant T6-6061 Aluminum Alloy, which receives a military-grade finish.

The AccentoLume® sends out a large elliptical light pattern – light projects only 2' behind the fixture, 18' forward and 15' wide, but no higher than knee level. This unique photometric quality solves the common problem of projecting glare-free light onto expanses of hardscape from the perimeter.

A deep cowling assures glare-free illumination even on most uphill viewing applications. When mounted in tall plant material the AL creates a mini-moonlight effect.



THE LIGHTING CHAMELEON

A great application for the AL is to mount it behind small garden walls or adjacent pathways to illuminate steps without the use of hard-to-install integral mount step or wall lights.

For best effect and longevity install AL's 12-24" behind planter or walkway edge (except when coming over wall to illuminate steps). Installing the AL a little behind the planter's edge will allow the beam to spread out wider and keep the fixture away from pedestrian traffic impact.

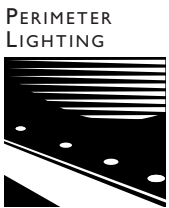
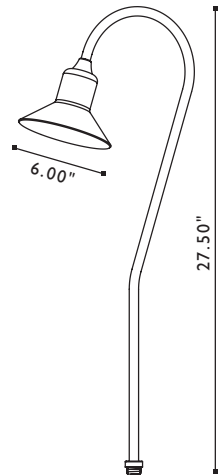

ACCENTOLUME® – ORDERING INFORMATION

The AL comes standard with a Frosted 12 watt Incandescent lamp, CapannaDiNoce® (CDS), and your choice of finish options.

STANDARD OPTIONS:

1 + 2 + 3 ORDERED TOGETHER ON SAME LINE

AVAILABLE LAMP CONFIGURATIONS:

Your choice of one lamp will come pre-installed.

FIXTURE/CODE	WATTAGE/CODE	AVG. LIFE HOUR
1 	2 INCANDESCENT LAMP OPTIONS:	
	12	2000
	18	2000
	25	2000

FINISH OPTIONS:

Choose from the following options. All have regular lead times.

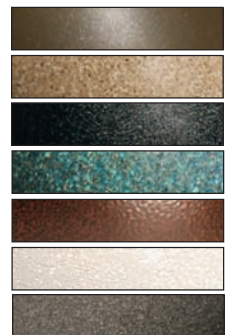
	CODE	DESCRIPTION
3 	BZ	Bronze Metallic
	DG	Desert Granite
	BF	Black Wrinkle
	VF	Verde Speckle
	SB	Sedona Brown
	WF	White Wrinkle
	WI	Weathered Iron

STANDARD PARTS:



ORDERING SAMPLE:

SECTIONS:	DESCRIPTION:	WHAT TO ORDER:
1 + 2 + 3 <small>optional</small>	 +  + 	= AL-12-BZ
A	PostMount®	= PM

NON-STANDARD OPTIONS:

MUST BE ORDERED ON SEPARATE LINE!

ADDITIONAL MOUNTING OPTIONS:

Comes pre-assembled with CapannaDiNoce®.

All other mounting options will arrive in separate box.

	CODE	DESCRIPTION	SIZE
	A		
	SJ	Superj-boX®	2.50" x 12.00"
	PM	PostMount®	2.50" x 13.00"

PHOTOMETRICS:

Spacing for minimum footcandle illumination on level ground.
 Note: 1fc for commercial projects
 .3fc for residential projects

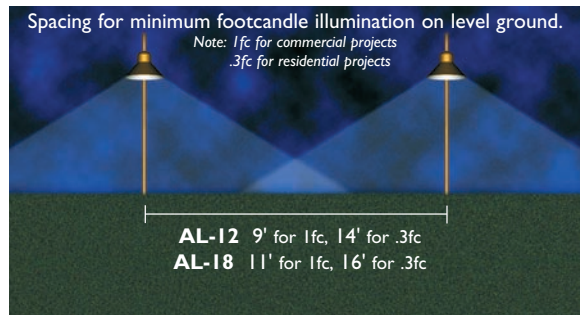

AL-12 9' for 1fc, 14' for .3fc
 AL-18 11' for 1fc, 16' for .3fc

	Footcandle Power		
	Distance	AL-12	AL-18
28' Unique elliptical light pattern	4'	1.1	1.4
	6'	.43	.53
	8'	.23	.27
	10'	.13	.16
	12'	.07	.11
	14'	.03	.06
	16'	.01	.03
	18'		.01

For conversion to lumens: Multiply footcandles x 10. See FX glossary for a full description of fc and lumens.

FX | LUMINAIRE®
PM-20



**BOLD, SOLID
 AND BEAUTIFUL**

The FX Luminaire® PostModerne® is engineered without compromise in the spirit of a large contemporary commercial bollard. Precisely milled from 6061 T-6 alloy, this model looks and performs like no other. Computer designed parabolic reflector, diffuser cone and optics work together to produce long projection beam spread with no glare.

This bold design is a great match for an edgy custom home in Santa Monica or a stainless steel railing beach pad in The Hamptons.

All exterior components are finished with a military marine-grade process of acid etching, chromate plating and polyester powdercoating to assure long-term appearance and integrity.

The most obvious application for the PM-20 is, of course, any project that speaks a sophisticated, clean and modern design language. The PM-20 can also be mounted on decks with optional deck mount.

POSTMODERNE® | FX LUMINAIRE®



UNLIMITED APPLICATIONS

We are constantly amazed at the range of projects in which the PM is used. From an NBA all-star's home in Milwaukee to a research science lab entry in La Jolla, the PM spans the architectural gamut. Simple form— high performance makes this fixture extremely versatile.



PostModerne® – ORDERING INFORMATION

The PM comes standard with a 20 watt Halogen AR-11 lamp, CapannaDiNoce® (CDS) and in any finish option.

STANDARD OPTIONS:

1 + 2 + 3 ORDERED TOGETHER ON SAME LINE





AVAILABLE LAMP CONFIGURATIONS:

Your choice of one lamp will come pre-installed.

FIXTURE/CODE	WATTAGE/CODE	DESCRIPTION
1 PM 	2 HALOGEN (H) LAMP OPTIONS:	
	20N-H	20 watt Halogen, narrow GBE 18° beam Avg. life 2000 hours

FINISH OPTIONS:

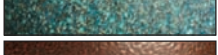
Choose from the following options. All have regular lead times.

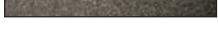
	CODE	DESCRIPTION
	3 BZ	Bronze Metallic
	DG	Desert Granite
	BF	Black Wrinkle
	VF	Verde Speckle
	SB	Sedona Brown
	WF	White Wrinkle
	WI	Weathered Iron

STANDARD PARTS:



Halogen AR-11

CapannaDiNoce®

ORDERING SAMPLE:

SECTIONS:	DESCRIPTION:	WHAT TO ORDER:
1 + 2 + 3	 +  + 	= PM-20-BZ
A	PostModerneDeckMount®	= PDM

NON-STANDARD OPTIONS:

MUST BE ORDERED ON SEPARATE LINE!

ADDITIONAL MOUNTING OPTIONS:

Mounting options will arrive in separate box.

	CODE	DESCRIPTION	SIZE
	A PDM	PostModerneDeckMount®	3.00" x 1.19"

PHOTOMETRICS:

Spacing for minimum footcandle illumination on level ground.
 Note: 1fc for commercial projects
 .3fc for residential projects



PM-20 3' for 1fc, 5' for .3fc
 (not recommended for commercial projects)

Footcandle Power (12R riser)	
Distance	PM-20
1'	1.2
2'	.40
3'	.20
4'	.10

For conversion to lumens: Multiply footcandles x 10. See FX glossary for a full description of fc and lumens.

FX | LUMINAIRE®
DR-10, DR-15, DR-20



**CLASSIC STYLING,
 RUGGED CONSTRUCTION**

The FX Luminaire® DellaRibalta® is our most popular pathlite. The oversized top keeps light directed downward for controlled pathway and color plant illumination without objectionable glare.

The DR-20 is constructed from die-cast aluminum alloy which receives a military-grade finish and polyester powdercoat for maximum durability. The riser is milled from solid T-6 6061 Aluminum Alloy for corrosion resistance and strength.

The DellaRibalta® is an excellent choice for a wide variety of task lighting applications, including pathways, motorcourt borders, pool and deck areas or color accent planters. Avoid using in open turf areas.

The DellaRibalta® incorporates a halogen lamp assembly for high output and long life which reduces operating and maintenance costs.

DELLARIBALTA® | FX LUMINAIRE®



3 Tier



2 Tier

RUGGED AND TIMELESS

Specify the DR-20-12R for most residential applications. For commercial sites the higher output DR-35-12R is a great choice. The DR can stand up to punishment and is component-based for easy repair, making it perfect for high-impact environments.

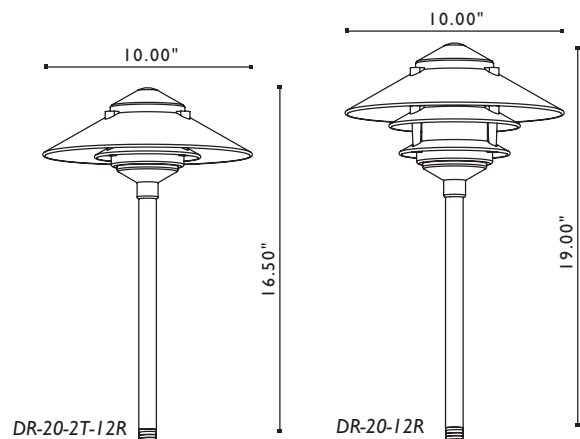

DELLARIBALTA® – ORDERING INFORMATION

The DR comes standard with a 20 watt Xenon G4 lamp, CapannaDiNoce® (CDS), 3 Tiers, 12 inch riser, and your choice of finish options.

STANDARD OPTIONS:

1 + 2 + 3 + 4 + 5 ORDERED TOGETHER ON SAME LINE

AVAILABLE LAMP CONFIGURATIONS:

Your choice of one lamp will come pre-installed.

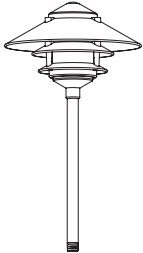
FIXTURE/CODE	WATTAGE/CODE	AVG. LIFE HOUR
	2 XENON LAMP OPTIONS:	
	10	10,000
	15	10,000
	20	5,000
	HALOGEN (H) LAMP OPTIONS:	
	10H	2000
	20H	2000

STANDARD TIER OPTION:

Comes Standard with 3 Tiers.

TIER CODE	DESCRIPTION
 3 3T	3 Tiers

OTHER TIER OPTION:

Must be specified if you need the following tier option:

 3 2T	2 Tiers
-------------------------------------------------------------------------------------------------	---------

STANDARD RISER OPTIONS:





Your choice of one riser option will come pre-assembled.

Riser Specs: Aluminum 0.5" Diameter

	4 8R	8" Riser
	12R	12" Riser
	18R	18" Riser

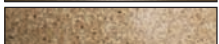
FINISH OPTIONS:

Choose from the following options. All have regular lead times.

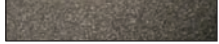
CODE	DESCRIPTION	
 5 BZ	Bronze Metallic	
	DG	Desert Granite
	BF	Black Wrinkle
	VF	Verde Speckle
	SB	Sedona Brown
	WF	White Wrinkle
	WI	Weathered Iron

STANDARD PARTS:

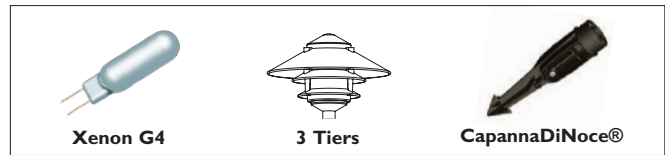

ORDERING SAMPLE:

SECTIONS:	DESCRIPTION:	WHAT TO ORDER:
1 + 2 + 3 + 4 + 5	 +  + 3T +  + 	= DR-20-12R-DG
A	PostMount®	= PM



NON-STANDARD OPTIONS:

MUST BE ORDERED ON SEPARATE LINE!

ADDITIONAL MOUNTING OPTIONS:

Comes pre-assembled with CapannaDiNoce®.

All other mounting options will arrive in separate box.

CODE	DESCRIPTION	SIZE
 A SJ	SuperJ-boX®	2.50" x 12.00"
	PM	PostMount® 2.50" x 13.00"

PHOTOMETRICS:

Spacing for minimum footcandle illumination on level ground.
 Note: 1fc for commercial projects
 .3fc for residential projects

DR-10 6' for 1fc, 9' for .3fc
 DR-20 8' for 1fc, 12' for .3fc
 DR-35 10' for 1fc, 15' for .3fc

Footcandle Power (12R riser)			
Distance	DR-10	DR-20	
14'			
12'	2'	1.1	2.3
10'	4'	.27	.61
8'	6'	.10	.14
6'	8'	.04	.06
4'	10'	.01	.03
2'	12'		.01
	14'		

For conversion to lumens: Multiply footcandles x 10. See FX glossary for a full description of fc and lumens.

FX | LUMINAIRE®
DS-10, DS-15, DS-20



CLASSIC STYLING
RUGGED CONSTRUCTION

The three-tiered DuroStrato® is without a doubt the all-time most popular of any outdoor fixture. Its classic styling blends in with both contemporary and traditional landscapes.

The DS-20 is constructed from die-cast aluminum alloy which receives a military grade finish and polyester powdercoat for maximum durability. Its textured rich bronze finish blends well with organic surroundings. The lamp assembly is enclosed by a shock-resistant frosted diffuser that keeps out moisture, insects and dirt while providing a soft illumination.

The DuroStrato® is an excellent choice for high traffic lighting applications – including public pathways, parking lot borders, community pool areas and color accent planters. Most pathlites are best used in planter areas to blend into surroundings – avoid using in open turf areas.

DUROSTRATO® | FX LUMINAIRE®



ATTENTION TO DETAIL

The DuroStrato® may seem plain and mundane at first glance. Upon closer inspection, you'll appreciate our use of aerospace alloys like the 6061-T6 risers. FX's commitment to using superior materials to prevent product failure is unmatched in the industry.

PERIMETER LIGHTING

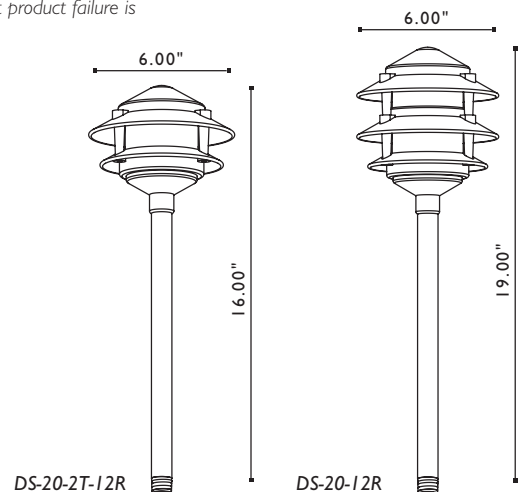

DUROSTRATO® – ORDERING INFORMATION

The DS comes standard with a 20 watt Xenon G4 lamp, CapannaDiNoce® (CDS), 3 Tiers, 12 inch riser, and your choice of finish options.

STANDARD OPTIONS:

1 + 2 + 3 + 4 + 5 ORDERED TOGETHER ON SAME LINE

AVAILABLE LAMP CONFIGURATIONS:

Your choice of one lamp will come pre-installed.

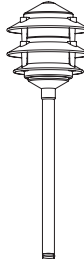
FIXTURE/CODE	WATTAGE/CODE	AVG. LIFE HOUR
1 DS 	2 XENON LAMP OPTIONS:	
	10	10,000
	15	10,000
	20	5000
	HALOGEN (H) LAMP OPTIONS:	
	10H	2000
	20H	2000

STANDARD TIER OPTION:

Comes Standard with 3 Tiers.

TIER CODE	DESCRIPTION
3 3T	3 Tiers

OTHER TIER OPTION:

Must be specified if you need the following tier option:

3 2T	2 Tiers
-------------	---------

STANDARD RISER OPTIONS:

Your choice of one riser option will come pre-assembled.

Riser Specs: Aluminum 0.5" Diameter

4 	8R	8" Riser
	12R	12" Riser
	18R	18" Riser

FINISH OPTIONS:

Choose from the following options. All have regular lead times.

CODE	DESCRIPTION
5 BZ	Bronze Metallic
DG	Desert Granite
BF	Black Wrinkle
VF	Verde Speckle
SB	Sedona Brown
WF	White Wrinkle
WI	Weathered Iron

STANDARD PARTS:

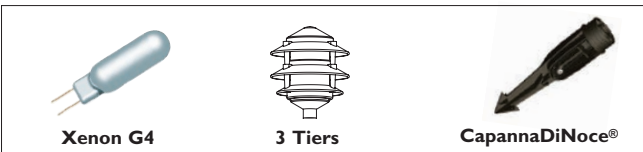

ORDERING SAMPLE:

SECTIONS:	DESCRIPTION:	WHAT TO ORDER:
1 + 2 + 3 + 4 + 5	 + 3T + 	= DS-20-12R-BZ
A	PostMount®	= PM

NON-STANDARD OPTIONS:

MUST BE ORDERED ON SEPARATE LINE!

ADDITIONAL MOUNTING OPTIONS:

Comes pre-assembled with CapannaDiNoce®.

All other mounting options will arrive in separate box.

CODE	DESCRIPTION	SIZE
A SJ	Superj-boX®	2.50" x 12.00"
PM	PostMount®	2.50" x 13.00"

PHOTOMETRICS:

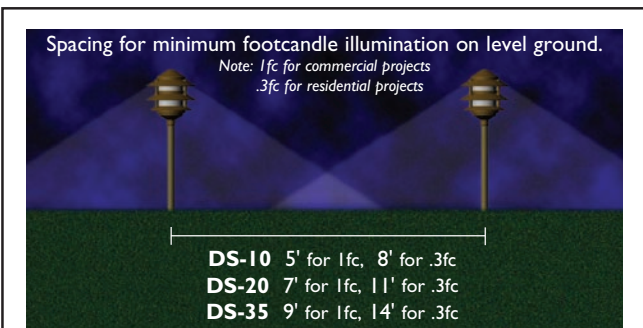

Distance	Footcandle Power (12R riser)		
	DS-10	DS-20	
14'			
12'	2'	1.0	2.2
10'	4'	.24	.58
8'	6'	.10	.12
6'	8'	.03	.05
4'	10'	.01	.03
2'	12'		.01

For conversion to lumens: Multiply footcandles x 10. See FX glossary for a full description of fc and lumens.

FX | LUMINAIRE®
TE-20, TE-35, TE-50



**HIGH PERFORMANCE,
 PRECISION BUILT**

Let's face it, nowadays most manufacturers are focused on quantity, not quality, and that can leave you sitting in the hot seat when a product fails. This is why FX has created the patented Terra Elemento® to add to our line of superb luminaires. The TE incorporates aerospace materials and marine components to insure its high performance in the most extreme environments.

The classic failure of well lights is moisture penetration into the lamp compartment, so, instead of trying to seal the entire unit, we decided to protect the only area that truly needs to be kept dry – the lamp housing. To accomplish this task, a patent pending water seal was designed that rivals underwater light performance.

A full three axis stainless steel aiming mechanism allows the installer to precisely target landscape elements while minimizing unwanted glare.

U.S. Patents No. 6,491,407;
 6,612,720

RAW MATERIALS



The TE's body is precision milled to tolerances reaching 1/110,000 of an inch from solid billet aerospace grade aluminum alloy. There are many different alloys from which to choose – FX uses only materials that provide maximum corrosion resistance, mechanical strength and superior thermal dispersion qualities.

POLYESTER POWDER COAT



FX can count on one hand our competitors that finish their products in-house. Of those, no one has a system that will produce a higher quality longer lasting finish than FX. Our proprietary finish chemistry / compounds and state of the art finishing system allows FX to extend the longest warranty in the industry.

THE EXTRA EFFORT

After milling, the individual components are hand finished to remove burrs and check tolerances to strict quality standards. We then plate the parts, etching and sealing the alloy to further enhance corrosion resistance.

This military spec multi-stage plating process protects bare metal areas such as threaded holes and prevents corrosion "creep" under the powdercoat finish.

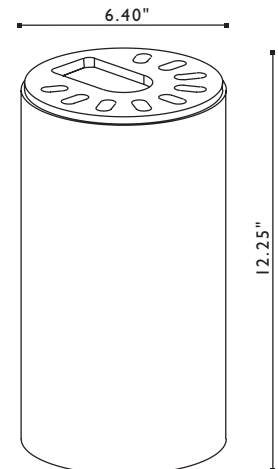

**UPLIGHTING
 TREES**



**ARCHITECTURAL
 ACCENTS**



TERRAELEMENTO® – ORDERING INFORMATION

TE comes standard with any watt Halogen (H) MR-16 lamp, Clear Lens and in Brass (BS).

STANDARD PARTS:



ORDERING SAMPLE:

SECTIONS:	DESCRIPTION:	WHAT TO ORDER:
1 + 2 + 3 <small>optional</small>	+ +	= TE-20
A and/or B	HexBaffle®	= HB
	Frosted	= F

STANDARD OPTIONS:

1 + 2 + 3 ORDERED TOGETHER ON SAME LINE

STANDARD LAMP CONFIGURATIONS:

Choose from any watt Halogen (H).

FIXTURE/CODE	WATTAGE/CODE	DESCRIPTION
	2 HALOGEN (H) LAMP OPTIONS:	
	20H	20 watt Halogen, wide, 36° beam, Avg. life 5000 hours; now available in 10000 hours <i>(new)</i>
	20V-H	20 watt Halogen, very narrow, 10° beam, Avg. life 5000 hours
	35H	35 watt Halogen, wide, 36° beam, Avg. life 5000 hours; now available in 10000 hours <i>(new)</i>
	35V-H	35 watt Halogen, very narrow, 10° beam, Avg. life 5000 hours
	50H	50 watt Halogen, wide, 36° beam, Avg. life 5000 hours; now available in 10000 hours <i>(new)</i>
	50N-H	50 watt Halogen, narrow, 25° beam, Avg. life 5000 hours;
	50V-H	50 watt Halogen, very narrow, 10° beam, Avg. life 5000 hours

LAMP NOTE:

Some lamps are by special order. Please check with our factory for availability.

FINISH OPTIONS:

Brass is standard. All other choices must be specified.

	BS	Brass <i>(will naturally patina)</i>
--	----	-----------------------------------------

NON-STOCKING FINISH OPTIONS:

Allow extra time for the following finish options:

	CODE	DESCRIPTION
	3 NP	Nickel Plate

NON-STANDARD OPTIONS:

A AND B, MUST BE ORDERED ON SEPARATE LINE!

ADDITIONAL GLARE CONTROL OPTIONS:

Does not come pre-assembled with glare control.

Glare Control Options will arrive in separate box.

	CODE	DESCRIPTION
	A HB	HexBaffle® (shown at left)
	RR	RecessorRing®

ADDITIONAL LENS OPTIONS:

Comes pre-assembled with a clear lens. All others will arrive in separate box.

	CODE	DESCRIPTION
	B F	Frosted Lens
	S	Spread Lens
	SO	Solite Lens
	CF-1	Peach Lens
	CF-2	Blue Lens
	CF-3	Green Lens
	CF-4	Red Lens

FX | LUMINAIRE®
CF-20, CF-35



THE ANSWER TO YOUR
WELLITE DREAMS

Patent Pending design and superior fire resistant materials address this industry-wide issue of fire risk with several Xclusive features. The integral honey comb grate serves to prevent debris build up and provides superior glare protection. Xclusive Xenon PAR36 lamps are available in both 20 and 35 watts.

Where the typical PAR36 lamp is rated at 300-3000 hours, the Luxor® Xenolux® lamp is rated at 8000 hours! Patent Pending rail system allows for easy lamp access and fine tuning. No sharp Stainless edges to cut your fingers. Xclusive Patent Pending KoolLenz® system provides wider beam spread and color temp modification to enhance green plant tones.

CRATEREFURBO® | FX LUMINAIRE®



THE BEST HOUSE ON THE BLOCK
Fully encapsulated lamp housing keeps terminals and lamp from being stuck in the mud. This is a very common source of system problems with inferior PAR36 WellLite products. The CF goes both ways – just flip the housing and, as if by magic, the grate fits both sides! The grate is both Lawn Mower and Planter Debris approved for application flexibility.

This lighting fixture is rated for transient landscape moisture – it is not an underwater light.

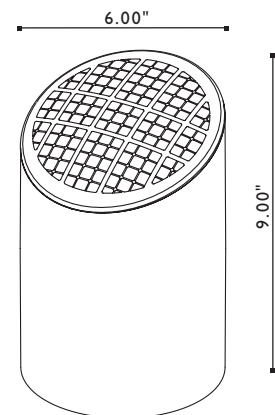

UPLIGHTING
TREES



ARCHITECTURAL
ACCENTS



CRATEREFURBO® – ORDERING INFORMATION

CF comes standard with a 20 watt Xenolux® PAR36 lamp, and your choice of color.

STANDARD PARTS:



Halogen PAR36

ORDERING SAMPLE:

SECTIONS:	DESCRIPTION:	WHAT TO ORDER:
1 + 2 + 3	+ +	= CF-20-FB

STANDARD OPTIONS:

1 + 2 + 3 ORDERED TOGETHER ON SAME LINE

STANDARD LAMP CONFIGURATIONS:

Choose from any watt Xenolux® or Halogen (H). Xenolux® is standard.

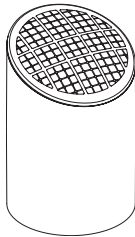
FIXTURE/CODE	WATTAGE/CODE	DESCRIPTION
1 CF 	2 XENOLUX® LAMP OPTIONS:	
	20	20 watt Halogen, wide, 40° beam, Avg. life 8000 hours
	35	35 watt Halogen, wide, 40° beam, Avg. life 8000 hours

COMPOSITE FINISH OPTIONS:

Choose from the following options. All have regular lead times.

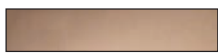
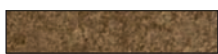
	CODE	DESCRIPTION
	3 DT	Desert Tan
		FB

Note: Composite finishes can not be powdercoated.

INSTALLATION NOTE:

For application flexibility, the CF can be installed at either end. The grate and lamp will fit both the angled or flat side of the CF body.



Angled Installation



Flat Installation

FX | LUMINAIRE®
 FC-20

SPECIALTY
 LIGHTING

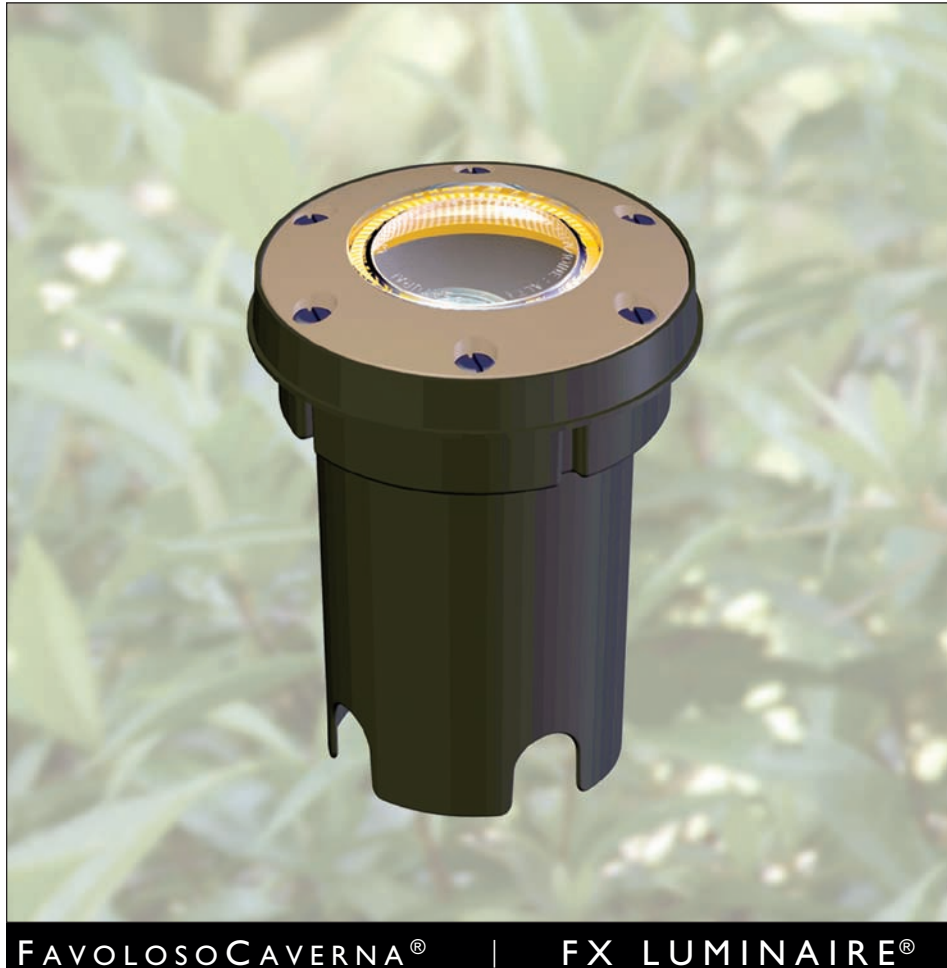

RETHINK LIGHTING BY
 GOING UNDERGROUND

At FX, we understand bigger is not always better. Like the MP miniature spotlight, the subterranean FC introduces glare-free controlled illumination into smaller scale spaces. Applications can include installing behind a potted plant and in front of the column at the entry to a stately residence. The variety of cowling and lamp options allows the FC to have an answer to most of lighting's pint-size problems.

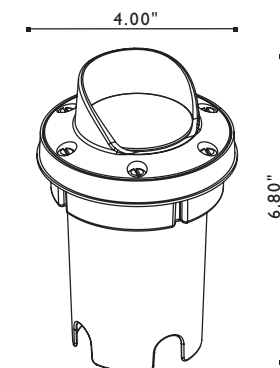
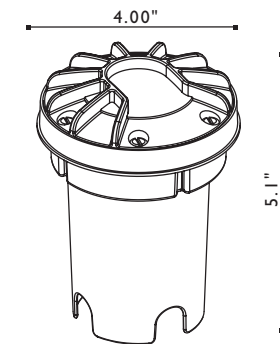
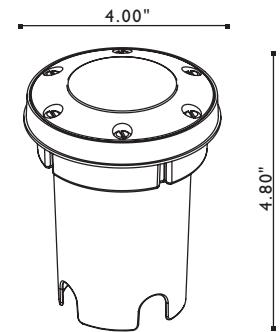

FAVOLOSO CAVERNA® | FX LUMINAIRE®



INCREASE YOUR PASSION

You have a passion for your garden. With FX, soon that passion will be for lighting, and your garden will never be the same. You can't put just anything into a well-designed landscape. The FC will bring controlled light into a scene without exposing the source or overpowering the subject matter. Get ready to rethink lighting.

This lighting fixture is rated for transient landscape moisture - it is not an underwater light.

UPLIGHTING
 TREES



ARCHITECTURAL
 ACCENTS



FAVOLOSOCAVERNA® – ORDERING INFORMATION

FC comes standard with a 20 watt Halogen MR-11 lamp, and your choice of color.

STANDARD PARTS:



Halogen MR-11

STANDARD OPTIONS:

1 + 2 + 3 ORDERED TOGETHER ON SAME LINE

AVAILABLE LAMP CONFIGURATIONS:

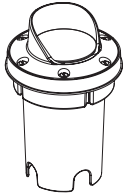

Your choice of one lamp will come pre-installed.

FIXTURE/CODE	WATTAGE/CODE	DESCRIPTION
1 FC	2 HALOGEN LAMP OPTIONS:	
	20H	20 watt Halogen, wide, 36° beam, Avg. life 2000 hours

ORDERING SAMPLE:

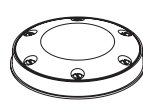

SECTIONS:	DESCRIPTION:	WHAT TO ORDER:
1 + 2 + 3 + 4 <small>optional</small>	FC +  +  + 	= FC-20H-CW-CB

GRATE OPTIONS:

	CODE	DESCRIPTION
	3 CW	Cowling
	LV	Louwer
	RG	Ring

FINISH OPTIONS:

Choose from the following options. All have regular lead times.

	CODE	DESCRIPTION
	4 BS	Brass <i>(will naturally patina)</i>
	NP	Nickel Plate

COMPOSITE FINISH OPTIONS:

Choose from the following finish options All have regular lead times.

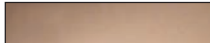
	CODE	DESCRIPTION
	4 CB	Camo Bronze
	DT	Desert Tan

Note: Composite finishes can not be powdercoated.

FX | LUMINAIRE®
 RP-20, RP-35, RP-50



RESISTENTEPILOTARE® | FX LUMINAIRE®

READY TO MEET YOUR
 SUBTERRANEAN DEMANDS

When power and control are demanded from a subterranean fixture, you will not find a more versatile product than the Patent Pending RP. It can be configured to wall wash from tight spaces with a spread beam or provide a long narrow projection of light for a tall palm... even after installation. There is a whole family of accessories to allow the lighting designer to shape, color and glare control light for maximum effect.

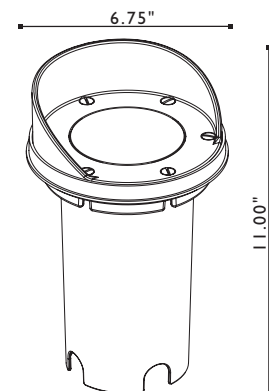
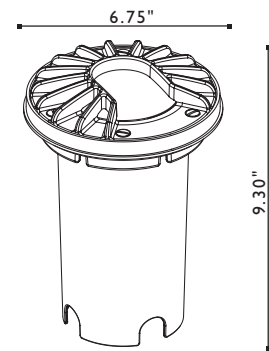
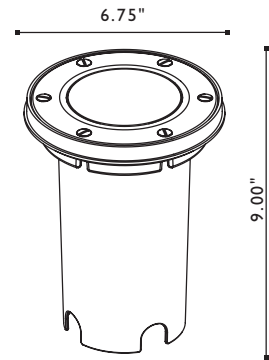

DO YOU LIKE TO BE IN CONTROL?
 Then go underground with the patent pending RP. Do you need to wall wash from tight spaces? No problem. But, what if you need a long projection of light for a large tree? Sure, it can do that too, even after installation. For those who appreciate excellence, this is the light your landscape can't be without.

This lighting fixture is rated for transient landscape moisture - it is not an underwater light.

UPLIGHTING
 TREES



ARCHITECTURAL
 ACCENTS



RESISTENTEPILOTARE® – ORDERING INFORMATION

RP comes standard with any watt Halogen MR-16 lamp, and your choice of color.

STANDARD PARTS:



ORDERING SAMPLE:

SECTIONS:	DESCRIPTION:	WHAT TO ORDER:
1 + 2 + 3 + 4 <small>optional</small>	RP + + +	= RP-20-CW-CB

STANDARD OPTIONS:

1 + 2 + 3 + 4 ORDERED TOGETHER ON SAME LINE

STANDARD LAMP CONFIGURATIONS:

Choose from any watt Halogen (H).

FIXTURE/CODE	WATTAGE/CODE	DESCRIPTION
1 RP 	2 HALOGEN (H) LAMP OPTIONS:	
	20H	20 watt Halogen, wide, 36° beam, Avg. life 5000 hours; now available in 10000 hours <small>(new)</small>
	20V-H	20 watt Halogen, very narrow, 10° beam, Avg. life 5000 hours
	35H	35 watt Halogen, wide, 36° beam, Avg. life 5000 hours; now available in 10000 hours <small>(new)</small>
	35V-H	35 watt Halogen, very narrow, 10° beam, Avg. life 5000 hours
	50H	50 watt Halogen, wide, 36° beam, Avg. life 5000 hours; now available in 10000 hours <small>(new)</small>
	50N-H	50 watt Halogen, narrow, 25° beam, Avg. life 5000 hours;
	50V-H	50 watt Halogen, very narrow, 10° beam, Avg. life 5000 hours

LAMP NOTE:

Some lamps are by special order. Please check with our factory for availability.

GRATE OPTIONS:

	CODE	DESCRIPTION
	3 CW	Cowling
	LV	Louver
	RG	Ring

FINISH OPTIONS:

Choose from the following options. All have regular lead times.

	CODE	DESCRIPTION
	4 BS	Brass <small>(will naturally patina)</small>
	NP	Nickel Plate

COMPOSITE FINISH OPTIONS:

Choose from the following finish options All have regular lead times.

	CODE	DESCRIPTION
	4 CB	Camo Bronze
	DT	Desert Tan

Note: Composite finishes can not be powdercoated.

FX | LUMINAIRE®
SM-20

SPECIALTY
LIGHTING



STELLAMINUTO® | FX LUMINAIRE®

THE SHINING STAR TO YOUR UNDERWATER FEATURE

Small in size, using the MR-11 lamp, the SM can bring aesthetic beauty to any aquatic scene. With the subtlety of low voltage fixtures, a homeowner's garden pool by day can turn into an enchanting and romantic grotto by night.

Not only does it provide beauty, but the SM also is versatile in its application. The stand that is provided with the fixture can be easily adjusted to the angle of your liking. The stand is also removable, so that it can be deceptively concealed in soil or gravel.



GREAT LIGHT OUTPUT CAN COME FROM THE SMALLEST OF FIXTURES

For something small in size, easily adjustable, and captivating in light output, nothing beats the StellaMinuto.

This lighting fixture should be used submerged in water only. Stand is optional.

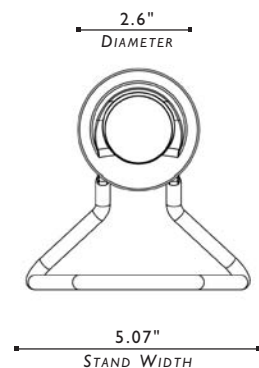
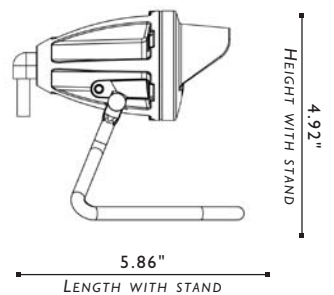
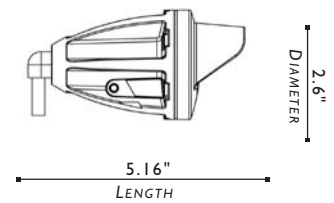

UNDERWATER
LIGHTING



STELLAMINUTO® – ORDERING INFORMATION

SM comes standard with a 20 watt Halogen MR-11 lamp, Clear Lens, and Brass material.

STANDARD PARTS:



ORDERING SAMPLE:

SECTIONS:	DESCRIPTION:	WHAT TO ORDER:
1 + 2 + 3	+ +	= SM-20-BS
A and/or B	HexBaffle®	= HB

STANDARD OPTIONS:

1 + 2 + 3 ORDERED TOGETHER ON SAME LINE

STANDARD LAMP CONFIGURATIONS:

Choose from any watt Halogen (H).

FIXTURE/CODE	WATTAGE/CODE	DESCRIPTION
1 SM 	2 HALOGEN (H) LAMP OPTIONS:	
	20H	20 watt Halogen, wide, 36° beam, Avg. life 2000 hours
	35H	35 watt Halogen, wide, 36° beam, Avg. life 2000 hours;

LAMP NOTE:

Some lamps are by special order. Please check with our factory for availability.

STANDARD FINISH OPTIONS:

Choose from the following options. All have regular lead times.

CODE	DESCRIPTION
3 BS 	Brass

CORD NOTE:

Standard cord length is 16'. Custom lengths are available for additional price.

NON-STANDARD OPTIONS:

A AND B, MUST BE ORDERED ON SEPARATE LINE!

ADDITIONAL GLARE CONTROL OPTIONS:

Does not come pre-assembled with glare control, they will arrive in separate box.

CODE	DESCRIPTION
A HB - MP 	HexBaffle®

ADDITIONAL LENS OPTIONS:

Comes pre-assembled with a clear lens. All others will arrive in separate box.

CODE	DESCRIPTION
B FL-2 	Frosted Lens
CF-5	Peach Lens
CF-6	Blue Lens

FX | LUMINAIRE®
 LB-20, LB-35, LB-50

SPECIALTY
 LIGHTING

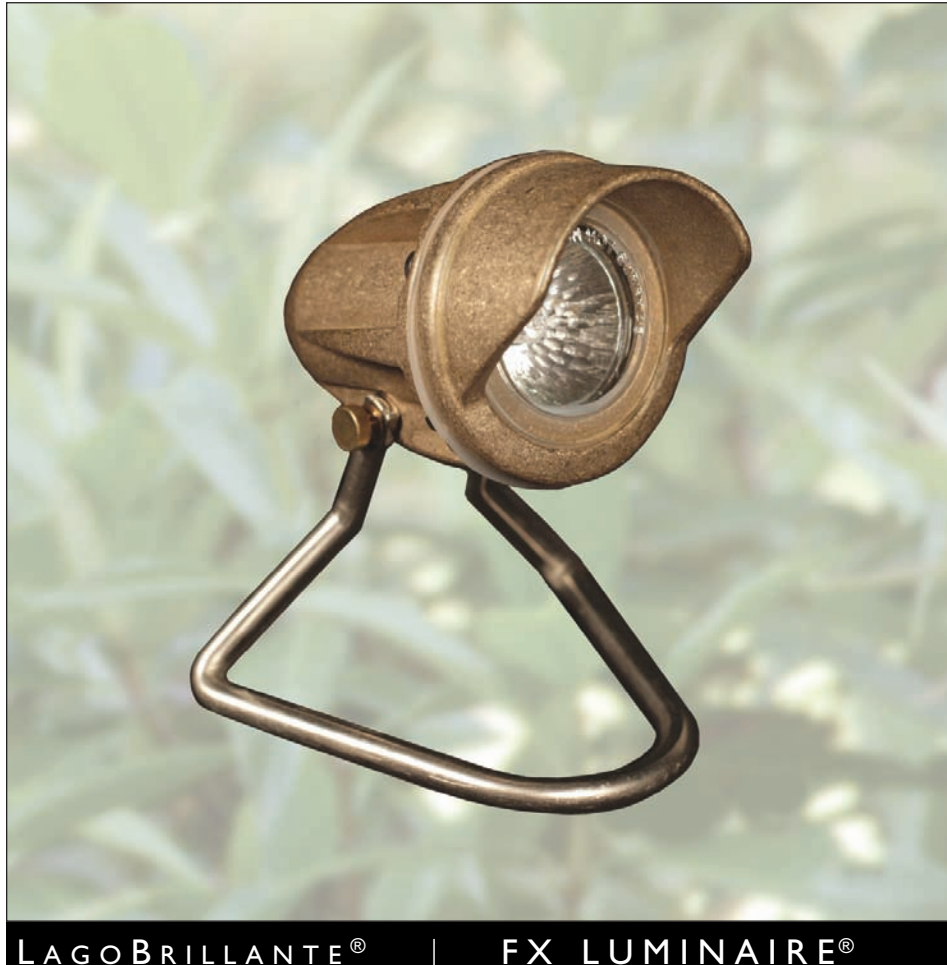

LAGOBRILLANTE® | FX LUMINAIRE®



UNDERWATER
 LIGHTING



UNDERWATER ILLUMINATION AT ITS BEST
 This underwater gem offers several different filter options that allow the designer to shape, color shift, and control light output.

This lighting fixture should be used submerged in water only. Stand is optional.

LB STACK OPTIONS

Stack A:
 Configuration: No HexBaffle® / No Filters

Stack B:
 Configuration: HexBaffle® / No Filter

Stack C:
 Configuration: No HexBaffle® / 1 or 2 Filters

Stack D:
 Configuration: HexBaffle® / 1 Filter

ADD SOME BRILLIANCE
 TO YOUR WATERSCAPE

Nothing is more soothing, like the sound and presence of moving water. Many have discovered that a water feature is a wonderful addition to any outside space, which can take on a new dimension at night with well designed lighting.

Big brother to the StellaMinuto (SM), the MR-16 LB produces a powerful light output and may be used to illuminate plants, fish or rocks, or aim it directly up any waterfall.

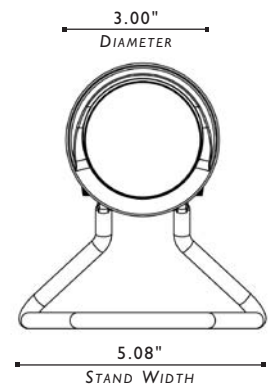
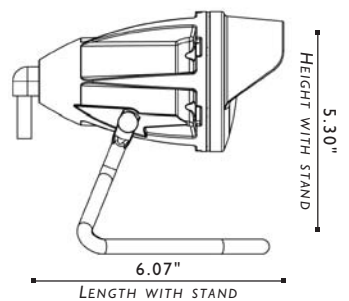
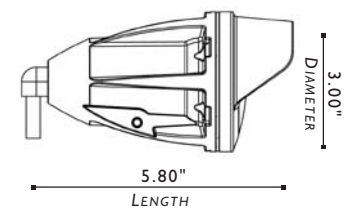

LAGOBRILLANTE® – ORDERING INFORMATION

MU comes standard with a 20 watt Titan MR-16 lamp, Clear Lens, and Brass material.

STANDARD PARTS:



ORDERING SAMPLE:

SECTIONS:	DESCRIPTION:	WHAT TO ORDER:
1 + 2 + 3	+ +	= LB-20-BS
A and/or B	HexBaffle®	= HB

STANDARD OPTIONS:

1 + 2 + 3 ORDERED TOGETHER ON SAME LINE

STANDARD LAMP CONFIGURATIONS:

Choose from any watt Titan Halogen.

FIXTURE/CODE	WATTAGE/CODE	DESCRIPTION
1 LB 	2 TITAN HALOGEN LAMP OPTIONS:	
	20Titan	20 watt Titan Halogen, wide, 36° beam, Avg. life 12,000 hours
	35Titan	35 watt Titan Halogen, wide, 36° beam, Avg. life 18,000 hours
	50Titan	50 watt Titan Halogen, wide, 36° beam, Avg. life 18,000 hours

LAMP NOTE:

Some lamps are by special order. Please check with our factory for availability.

STANDARD FINISH OPTIONS:

Choose from the following options. All have regular lead times.

CODE	DESCRIPTION
3 BS	Brass

CORD NOTE:

Standard cord length is 16'. Custom lengths are available for additional price.

NON-STANDARD OPTIONS:

A AND B, MUST BE ORDERED ON SEPARATE LINE!

ADDITIONAL GLARE CONTROL OPTIONS:

Does not come pre-assembled with glare control, they will arrive in separate box.

CODE	DESCRIPTION
A HB	HexBaffle®

ADDITIONAL LENS OPTIONS:

Comes pre-assembled with a clear lens. All others will arrive in separate box.

CODE	DESCRIPTION
B	F Frosted Lens
	S Spread Lens
	SO Solite Lens
	CF-1 Peach Lens
	CF-2 Blue Lens
CF-3 Green Lens	
CF-4 Red Lens	

FX | LUMINAIRE® ACCESSORIES

ACCESSORIES

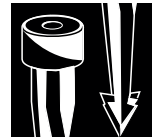

SSS – SUPER SLOT SPIKE®



This 8" spike is the standard for all FX uplites and small pathlites. Constructed from UV resistant ABS it incorporates a composite thread insert featuring a slot cut out of the threads for your wires. No fumbling with the wires when trying to attach the spike!

CDS – CAPANNADINOCE®



The CapannaDiNoce® features a water-resistant compartment where you can do the LiteSplice. No more baggies! The compartment also has a place to store your service coil, hold your wire nuts, and thread your run in/out the bottom. This new spike will make it easier to drive it into the toughest turf, while the barbed tip will help it stay put.

SJ – SUPERJ-BOX®



The top cap of the SJ is solid brass or powdercoated aluminum alloy. Fits onto our CapannaDiNoce® to create an attractive, easy to install wirenut J-Box. Use on visible entryway path and uplites.

PM – POSTMOUNT®



For commercial projects or where a clean finish is needed for the cable connection specify the Post Mount®. Milled from solid brass or aluminum alloy and powdercoated to match any standard FX finish. Includes 12" PVC pipe mount. Sturdier than the Super J-Box® when cast into a concrete footer. 2.50" x 12.50"

MJ – MINI J-BOX®

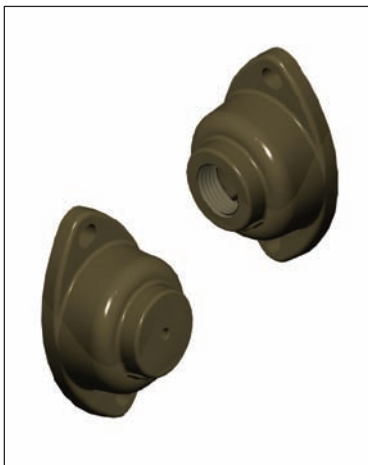

This micro aluminum option allows the TrellisSolare® (MJ-TS) and the MU spotlight fixture (MJ-MU) to be surface mounted to trees and eaves without an exposed wirenut connection. Comes with all necessary mounting hardware. Available in all standard FX finishes. 3.50" x 2.125" x 1.320"

VB – VERSABOX®



The VersaBox® is an innovative patent pending mounting box that can be screw mounted to an eave or surface mounted on decks. Use the VB with all FX pathlites, spotlites or TS series downlites. Made from solid brass, can be powdercoated with any of our standard finishes. 2.25" dia. x 1.75"

PDM – POSTMODERNEDECKMOUNT®



The PostModerneDeckMount is made conveniently for the PostModerne to be surface mounted on decks. Made from solid brass, can be powdercoated with any of our standard finishes. 3.00" dia. x 1.19"

FX | LUMINAIRE®

ACCESSORIES

LSK – LITESPLICE® KIT



To ensure long-term performance and integrity of your FX lighting system all underground cable splices must be protected from moisture and corrosive fertilizer chemicals. SpliceGel combined with the LiteSplice® kit includes materials for 25 two conductor splices.

WL – WELLLITE®



Similar to the LiteGuard® but designed for installation in turf or gravel areas where a flush mounted uplight is required. This model is not recommended for use in areas that receive ground cover as it will obscure the optical opening after a short time.

LG – LITEGUARD®

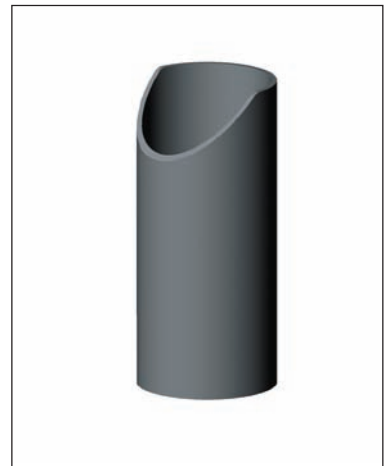

When mounting an uplight in a planter or gravel area is desired specify the LiteGuard®. The housing protects the uplight from plant material and keeps it out of sight. The open top design facilitates fixture adjustment and relamping.

HB – HEXBAFFLE®

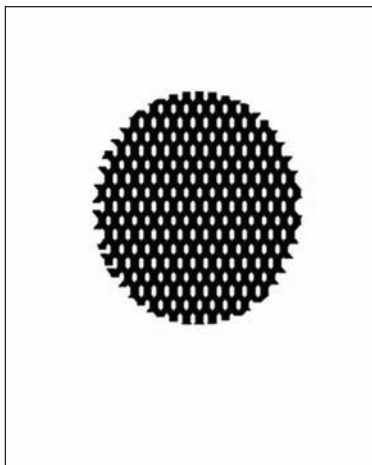

The alloy honeycomb HexBaffle® fits inside the lens cap of all FX spotlight fixtures to internally cut off light spill to 45°.

RR – RECESSORRING®







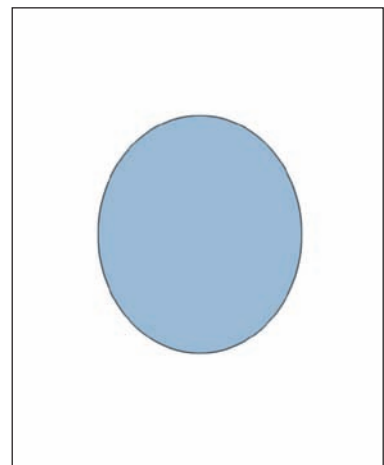







To reduce glare to a minimum specify the RecessorRing® option for the MU, LO and TE. This patented alloy unit fits inside the fixture housing (in front of the lamp) recessing it back away from the fixture opening thereby internally cutting off glare. An excellent choice for downlighting or pathway planter uplighting (walk-by view) with the MU spotlight. U.S. Patent No. 6,612,720

FILTERS



Color filters shift color tone to enhance desired effect. FX stocks many different color filters and lenses. Color filters include red, blue, green and peach. Clear, frosted and spread also available.

ACCESSORIES | LAMP OPTIONS

LAMP	COMMENTS	WATTAGE	BEAM ANGLE	FOR USE WITH
 Halogen MR-8	2000 Average Life Hour	20	Wide	CG
		20N	Narrow	CG
 Halogen MR-11	2000 Average Life Hour	10	Wide	SM
		20	Wide	FC, MP, SM
		35	Wide	CL, TS, SM
 Halogen MR-16	5000 Average Life Hour 10,000 Hour option available (for fixtures using 20/35/50 watt)	20	Wide	LO, LR, MU, RP, RS, TE
		20V	Very Narrow	LO, LR, MU, RP, RS, TE
		35	Wide	LO, LR, MU, RP, RS, TE
		50	Wide	LO, LR, MU, RP, TE
		35V	Very Narrow	LO, LR, MU, RP, RS, TE
		50N	Narrow	LO, LR, MU, RP, TE
		50V	Very Narrow	LO, LR, MU, RP, TE
 Titan Halogen MR-16	12,000 Average Life Hour (for fixtures using 20 watt)	20	Wide	LB
	18,000 Average Life Hour (for fixtures using 35/50 watt)	35	Wide	LB
		50	Wide	LB
 Xenon G4	10,000 Average Life Hour (for fixtures using 10/15 watt)	10	N/A	BD, CA, CB, CM,CP, CR, CV, DL, DM, DP, DR, DS, EA, GT, MM, PF, PR, PV, QF, SC, SP, RL, UN
	5000 Average Life Hour (for fixtures using 20 watt)	15	N/A	BD, CA, CB, CV, DL, DM, DR, DS, EA, PF, PR, QF, SC, SP
		20	N/A	BD, CA, CB, CM, CR, CV, DL, DM, DR, DS, EA, GN, GT, LM, PD, PF, PR, QF, RL, SC, SP
 Halogen T3	2000 Average Life Hour	5	N/A	SI
		10	N/A	BD, CA, CB, CR, CV, DL, DM, DP, DR, DS, EA, GT, MM, PF, PR, PV, QF, RL, SC, SI, SP,
		20	N/A	BD, CA, CB, CR, CV, DL, DM, DR, DS EA, GT, PF, PR, QF, RL, SC, SI, SP,
		35	N/A	GN, GT, RL, SI
 Halogen AR-11	2000 Average Life Hour	20	Wide	CL, ML, TC, TS, VL
		20N	Narrow	CL, PM, TC, TS, VL
		20V	Very Narrow	CL, TC, TS, VL
 Halogen AR-20	2000 Average Life Hour	50	Wide	TS
		50N	Narrow	TS
 Incandescent 93	900 Average Life Hour	12	N/A	AL, FG, LS, TD
 Incandescent 1141	1200 Average Life Hour	18	N/A	AL, FG, TD
 Incandescent 1156	1200 Average Life Hour	25	N/A	AL, FG, TD
 Xenolux® PAR36	4000 Average Life Hour	20	Wide	CF
		35	Wide	CF

Beam Angle Key (approximate values)

Very Narrow- 10° | Narrow- 25° | Wide- 40° | Very Wide- 60°

FX | LUMINAIRE®

PHOTOMETRICS

MR-8 20W 10°

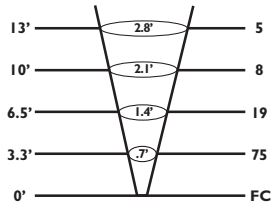

MR-8 20W 40°

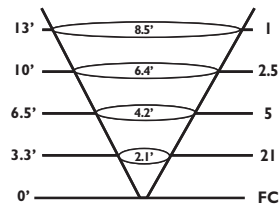

MR-11 20W 10°

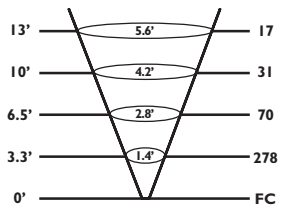

MR-11 20W 30°

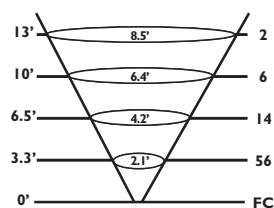

MR-16 20W 10°

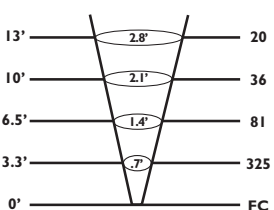

MR-16 20W 25°

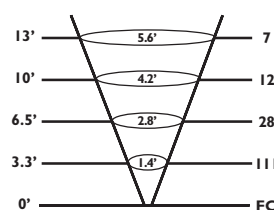

MR-16 20W 40°

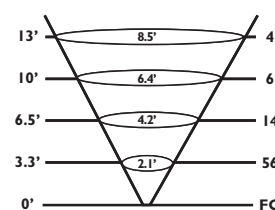

MR-16 35W 10°

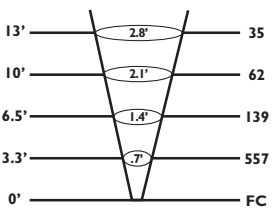

MR-16 35W 25°

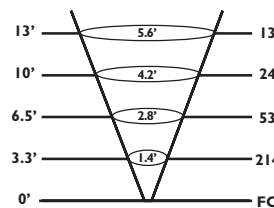

MR-16 35W 40°

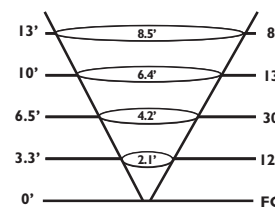

MR-16 50W 10°

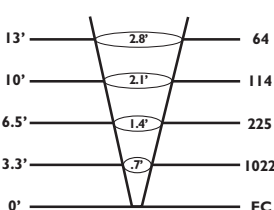

MR-16 50W 25°

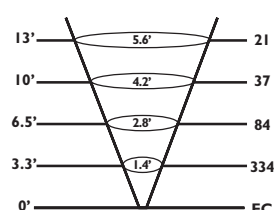

MR-16 50W 40°

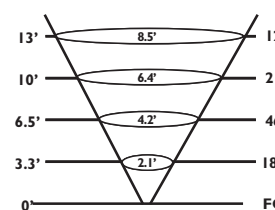

MR-16 50W 60°

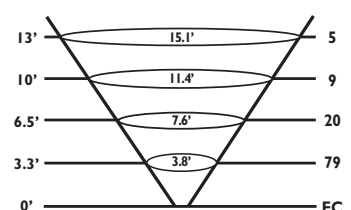

GLOSSARY

6061 Aluminum Alloy

An alloy that has a great balance of strength, machinability and corrosion resistance. The material from which many FX products are made.

Ambient Light

Lighting throughout a space that produces general illumination.

Ampere (amp)

Unit to express the flow quantity of electricity. Analogous to gallons per minute.

ANSI Code

ANSI stands for American National Standards Institute, the regulatory agency that develops standards for performance, dimensions, and safety. ANSI coded bulbs can be identified with a nationally-recognized three letter naming system, indicating that they meet ANSI standards.

Baffle

An accessory that was created to prevent light from producing glare at certain angles.

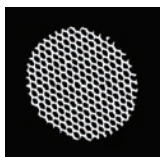

Ballast

Auxiliary unit used with HID lamps to provide the power to start the lamp and regulate the voltage, current and waveform while it is in use. A ballast is required for each HID lamp.

Brightness

A negative term associated with glare producing luminaries.

Bulb

Layman's term for "lamp."

Candela

The basic unit of measurement of luminous intensity from a light source in a specific direction.

Circuit Breaker

A switching device that can be manually operated that automatically opens (switches off) when more than the rated current passes through. Generally rated in amps. A typical residential 120v circuit breaker is 15 or 20 amps.

Color Temperature

An expression of light source color or whiteness, stated in degrees Kelvin. Warmer (more yellow) light has a lower color temperature and cooler light (more blue) has a higher color temperature.

Conductor

A metallic material that has low resistance to electrical flow such as copper. A circuit must have at least 2 conductors.

Downlighting

Like Uplighting, this is a general term that describes a group of effects that places the illuminating source above the target area. Downlighting can be used to light specific garden elements and pedestrian areas or to illuminate large spaces for safety, security or recreational purposes.



Efficacy (efficiency)

A measurement of how many lumens a lamp produces per watt consumed.

Fixture

Layman's term for "luminaire."

Floodlighting

Indiscriminate lighting of an area usually associated with security or utility functions.

Footcandle (fc)

A unit of measurement of luminescence. For reference: an office desktop typically has 50-75 fc of light falling on it if lit from overhead fluorescent lamps. A primary focal point tree in a residential garden should have about 5 fc average on it.

Fluorescent

A low-pressure lamp that has a phosphor coating that transforms ultraviolet energy into light. Although efficient they are physically very large.

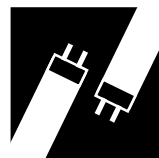

FX

Term to describe Lighting Effects, generally used in theatrical applications.

Gauge

A measurement of electrical conductor (wire or cable) size. The lower the number, the thicker the cable. 8-gauge cable is twice the size of 12-gauge.

Glare

A negative term describing uncontrolled light that produces discomfort to the viewer.

Ground

A non-current carrying metallic connection to earth. All 120v circuits must be grounded - 12v circuits do not. The green wire on a 120v circuit is typically the ground.

Ground Fault Interrupter (GFI)

A device that detects abnormal current patterns and shuts off power. GFI's are always required on outdoor circuits.

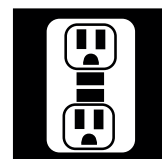

Halogen

See Tungsten-Halogen Lamp.

Hard Light

Light that produces very high contrast such as the grazing effect.

High Intensity Discharge (HID)

A lamp that produces light when electricity excites different gases within a pressurized glass envelope. HID lamps include mercury vapor, metal halide and high-pressure sodium types. See also Ballasts.

High Pressure Sodium Lamp

An HID lamp that produces light from sodium vapor, producing a distinctly yellowish color. Used widely as streetlights.

Hot

The conductor or surface that has voltage present. A hot and a common or neutral creates an electrical circuit. Usually color coded as the darker of all wires.

Illuminance

The amount of light striking a surface or object, measured in footcandles or lumens.



Incandescent Lamp

A lamp that produces light when electricity heats a tungsten metal filament.

Kelvin

Kelvin is a scale of temperature that can be used to determine the color of light. 4000K is a white light, a higher number is a cooler lamp, a lower number is a warmer lamp.



Lamp

Technical term for "bulb."

Lamp Life

Lamp life is rated in hours of operation. If lamps are rated for 4000 hours at 12 volts it means that at 4000 hours, 50% of the lamps are still working and 50% are not.

Line Voltage

Generally means 120 volts.

LEDz

Acronym for Light Emitting Diode. Can last over 80,000 hours. LEDs are very durable and give off less heat than incandescent lamps.

Low-voltage Lighting

A general term given to a system that is powered by a step-down transformer that reduces a 120v power input to a 12v output.

Lumen

The light that appears on a 12 x 12 inch surface from a source that is 12 inches away.

Luminaire

Technical term for "fixture." A complete lighting unit consisting of a lamp holder, lens and adjustable components.

Metal Halide Lamps

An HID lamp that produces light by radiation from metallic vapors. This type of HID lamp has the most neutral color rendering effect so it is appropriate for very large-scale color sensitive uplighting.

Neutral

A conductor that is common to other circuits and carries no current.

Ohm

A measurement of electrical resistance that causes voltage loss in circuits.

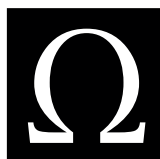

PAR Lamp

Parabolic aluminized reflector lamp or sealed beam lamp. Generally used for auto signal or headlights.

Pathlighting

The most visible source of lighting equipment comes from path lights. Pathlighting should be used to draw attention to pedestrian hazards such as grade changes or to illuminate surfaces that can't be reached by downlighting from trees, eaves and other architectural elements or integral wall mounted fixtures.

Patina Formula

A thin greenish layer, usually basic copper sulfate, that forms on copper or copper alloys, such as brass, as a result of corrosion. This process can be accelerated by using our patina formula found on our web site at: www.FXL.com/learning/patina.htm.

Powder Coat

Powder Coating is a completely dry finishing process that uses finely ground particles of pigment and resin which are electrostatically charged and sprayed on our products. The result is an attractive, durable, high-quality finish.

Quality of Lighting

A description of the aesthetic appearance of an illuminated environment indicating the use and control of light sources.

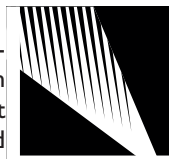

Reflectance

A measure of the amount of light that strikes a surface that is reflected. Light-colored smooth surfaces have a high reflectance.

Resistance

Measured in ohms - analogous to friction in hydraulics. A measurement of the restriction of the free flow of electrons in electrical conductors. Copper has a low resistance making it a good conductor. Glass has a high resistance making it a good insulator.

Short Circuit

An unwanted flow of current between two conductors causing the circuit breaker to trip.

Shield

An opaque unit that shields a light source from direct view at certain angles.

Task Lighting

The function of providing illumination for specific purposes such as recreation or utility.

Transformer

An electrical device used to step down 120-volt current to 12-volt for use on low-voltage lighting systems. A transformer provides roughly 1/10th of the input power.

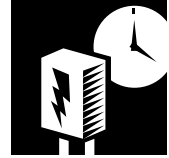

Tungsten-Halogen Lamp

A type of incandescent lamp containing a tungsten filament within a pressurized quartz envelope, which is filled with halogen gas. Also referred to as a quartz or halogen lamp. The halogen gas recycles the burned off tungsten particles back onto the filament thereby dramatically extending the lamp life.

Underwriters Laboratory (UL)

UL is an independent, not-for-profit product safety testing and certification organization. ETL, ARL, and several others perform the same service.

Uplighting

Description for several lighting techniques that use surface mounted or recessed fixtures aiming upward. This creates a dramatic effect that demands attention - thereby establishing focal points.

Volt (V)

Unit to describe the electrical force that causes current to flow - analogous to PSI in hydraulics.

Volt-Ampere (VA)

A measurement of potential. Volts x Amps = Watts. Most transformers' wattage ratings are expressed in VA.

Watt (W)

Unit of electrical consumption. See Volt-Ampere. Don't confuse wattage with light output - light is expressed in lumens or footcandles. Ex: heat lamps consume a lot of wattage but produce little light.

Xenon Lamp

A lamp that is more efficient, produces less heat and lasts up to four times longer than halogen.

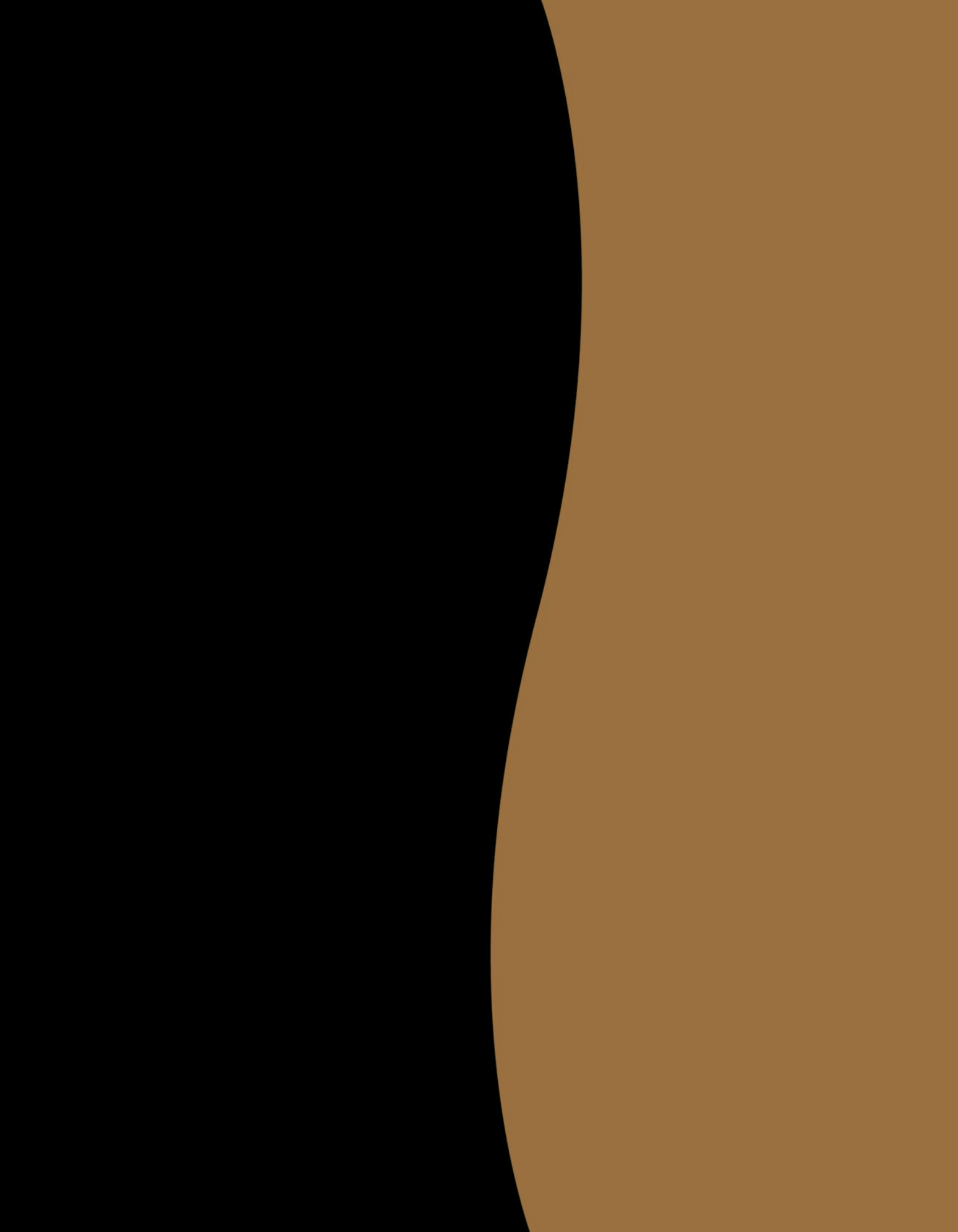



FX Luminaire® 800-688-1269 www.FXL.com®
specification grade low voltage exterior lighting components