

X-CORE®

EN Residential Irrigation Controller

Owner's Manual and Programming Instructions

DE Bewässerungssteuerung

Bedienungs- und Montageanleitung

ES Programador de riego residencial

Manual del usuario e instrucciones de instalación

FR Programmeurs X-Core pour Arrosage

Manuel de l'utilisateur et instructions de programmation du programmeur

IT Programmatorie X-Core

Manuale dell'utente ed istruzioni per la programmazione

PT Programador para Instalações de Rega Residencial

Manual do Utilizador e Instruções de Programação

TR Konutsal Sulama Kontrol Ünitesi

Kurulum, Programlama ve Kullanım Kılavuzu



Hunter®

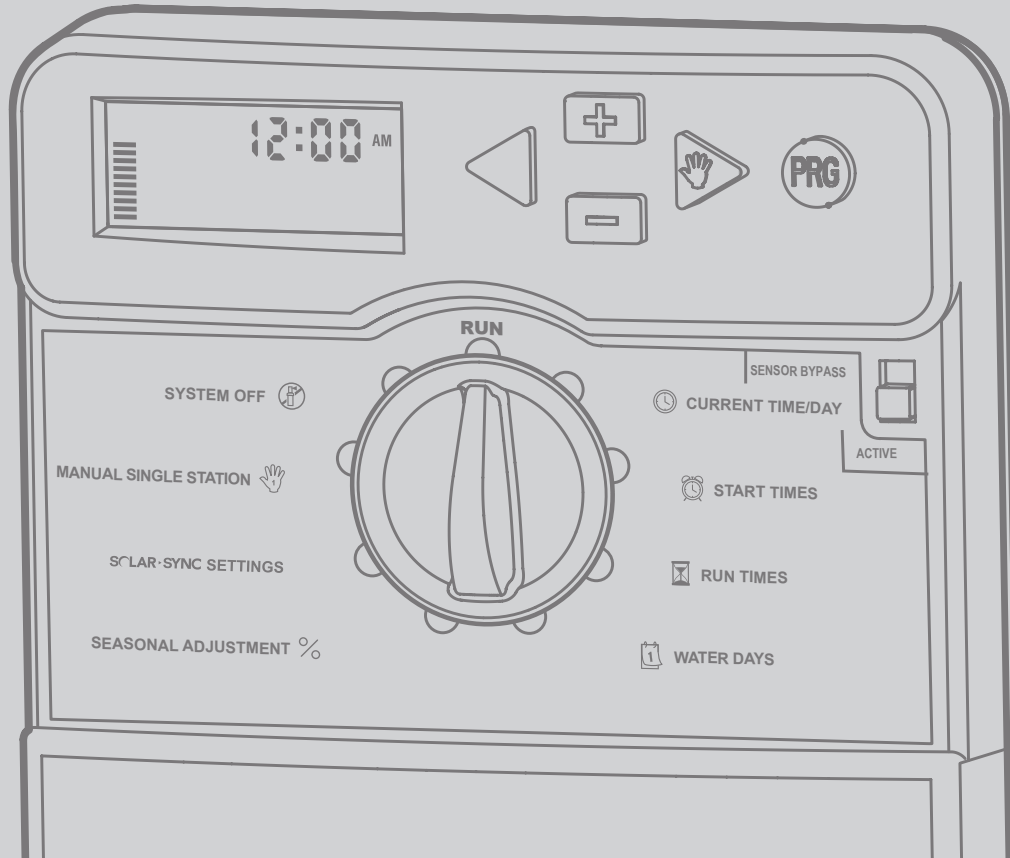



















TABLE OF CONTENTS

X-CORE COMPONENTS	4	Setting Days To Water 	21
MOUNTING THE CONTROLLER TO WALL	8	Selecting Specific Days of the Week to Water	21
CONNECTING VALVES AND TRANSFORMER	9	Selecting Odd or Even Days to Water	22
ACTIVATING THE BATTERY	10	Selecting Interval Watering 	22
REPLACING THE BATTERY	10	Setting Event Day(s) Off	22
CONNECTING A MASTER VALVE	11	Automatic Watering 	22
CONNECTING A PUMP START RELAY	12	System Off 	22
CONNECTING A HUNTER “CLIK” WEATHER SENSOR	13	Programmable Rain Off	23
Testing the Weather Sensor	13	Seasonal Adjustment %	23
Manually Bypassing the Weather Sensor	13	Manually Run a Single Station 	23
CONNECTING A HUNTER SOLAR SYNC ET SENSOR	14	One-Touch Manual Start and Advance	24
Installing Solar Sync Sensor	14	ADVANCED FEATURES	25
Installing the Wireless Solar Sync®	14	Programmable Sensor Override	25
Solar Sync Settings	14	Test Program of All Stations	25
Region 	15	Hunter Quick Check® Diagnostics	25
Water Adjustment 	16	Easy Retrieve™ Program Memory	26
Uninstalling a Solar Sync Sensor	14	Programmable Delay Between Stations	26
Calibration/Setup	17	Resetting Controller / Clearing Controllers Memory	26
Solar Sync Delay Feature	18	Clik Delay Instructions	27
CONNECTING A HUNTER REMOTE	19	Program Customization	28
Connecting to a Hunter Remote (not included)	19	Cycle and Soak	29
To install the SmartPort connector	19	TROUBLESHOOTING GUIDE	30
POWER FAILURES	19	SPECIFICATIONS	33
PROGRAMMING THE CONTROLLER	20	Operating Specifications	33
Setting the Date and Time 	21	Electrical Specifications	33
Setting the Program Start Time(s) 	21	Explanation of Symbols	33
Eliminating a Program Start Time	21	CERTIFICATE OF CONFORMITY TO EUROPEAN DIRECTIVES ...	34
Setting Station Run Times 	21		

X-CORE COMPONENTS

A LCD Display

1	 Run Times	Allows user to set each valve station run time from 1 minute to 4 hours
2	 Start Times	Allows 1 to 4 start times to be set in each program
3	Station Number	Indicates currently selected station number
4	Program Designator	Identifies program (A, B, or C) in use
5	Day of the Week	Identifies day of the week
6	Interval Watering	Identifies month when programming current date
7	Odd/Even Watering	Identifies if Odd or Even watering has been selected
8	Flashing Sprinkler	Indicates that watering is taking place
9	 System Off	Allows user to discontinue all programs and watering. Also allows the user to set the programmable “rain off,” which stops watering for a period from 1 to 7 days.
10	 Umbrella	Indicates that the rain sensor is active
11	% Seasonal Adjustment	Allows the user to make run time changes according to the seasons without reprogramming the controller. Bars on the left allow quick visual reference to the seasonal adjustment percentage. When using Solar Sync ET Sensor, will display seasonal adjust updated daily by sensor.
12	 Rain Drop	Indicates watering will occur on the selected day
13	 Crossed Rain Drop	Indicates the watering will NOT occur on the selected day
14	 Calendar	Indicates interval watering schedule has been programmed. Icon also appears when programming the current day

X-CORE COMPONENTS

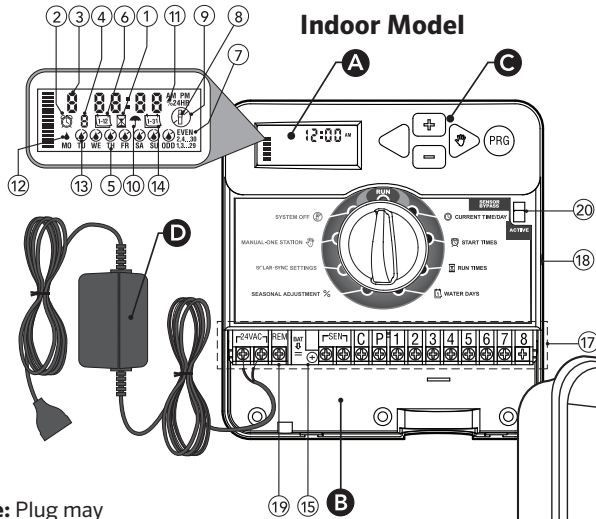



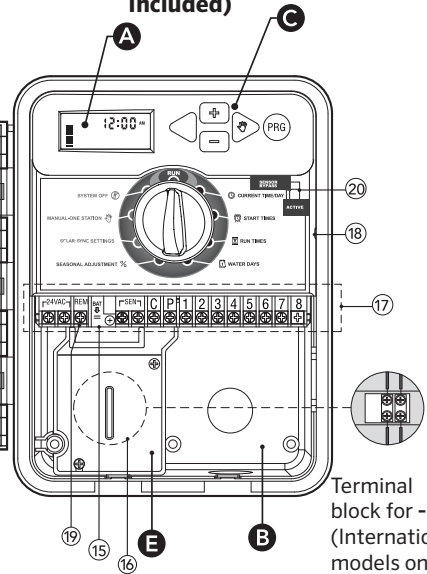

Note: Plug may look different from illustration







Outdoor Model (Internal Transformer Included)



X-CORE COMPONENTS

B Wiring Compartment		
15	Lithium Battery	The replaceable lithium battery (included) allows the controller to be programmed in the absence of AC power. In addition, the battery will provide power for backup timekeeping in the event of a power outage.
16	Internal Junction Box	Junction box in outdoor models for making AC power connections
17	Terminal Strip	Use to attach transformer, sensor, and valve wires from their source to the controller
18	Reset Button	Use to reset the controller (located on right side of controller)
19	REM	Allows for connection of Hunter SmartPort® and Hunter Remote Controls
20	Sensor Bypass Switch	Ignores “Clik” weather sensor input when in Bypass position
C Control Buttons		
	 Button	Increases the selected item flashing in the display
	 Button	Decreases the selected item flashing in the display
	 Button	Returns selected flashing display to previous item
	 Button	Advances the selected flashing display to the next item
	 Button	Selects program A, B, or C for different watering zone requirements

X-CORE COMPONENTS

Dial Settings		
	Run	Normal dial position for all controller automatic and manual operation
	 Current Time/Day	Allows current day and clock time to be set
	 Start Times	Allows 1 to 4 start times to be set in each program
	 Run Times	Allows user to set each valve station run time from 1 minute to 4 hours
	 Water Days	Allows the user to select interval days to water
	% Seasonal Adjustment	Allows user to make run time changes according to the seasons without reprogramming the controller. Bars on the left allow quick visual reference to the seasonal adjustment percentage.
	 Manual-One Station	Allows user to activate a one-time watering of a single valve
	 System Off	Allows user to discontinue all programs and watering. Also allows the user to set the programmable “rain off,” which stops watering for a period from 1 to 7 days
	SOLAR SYNC® Settings	Allows user to program settings when using Solar Sync ET Sensor
D External Transformer (Indoor Model Only)		
		A plug in transformer is provided to supply AC power to the controller

MOUNTING THE CONTROLLER TO WALL



NOTE: The indoor version of the X-Core is not waterproof or weather-resistant, and must be installed indoors or in a protected area.

1. Secure one screw into the wall. Install screw anchors if attaching to drywall or masonry wall.
2. Slide the keyhole on top of the controller over the screw.
3. Secure the controller in place by installing screws in the holes below the terminal strip.



NOTE: Do not plug transformer into power source until controller is mounted and all valve wiring has been connected.



NOTE: For XC - x01 - A: If the supply cord is damaged, it must be replaced by the manufacturer or service agent, or a similarly qualified person in order to avoid hazard.



NOTE: The door on outdoor units must remain closed for maximum water resistance.

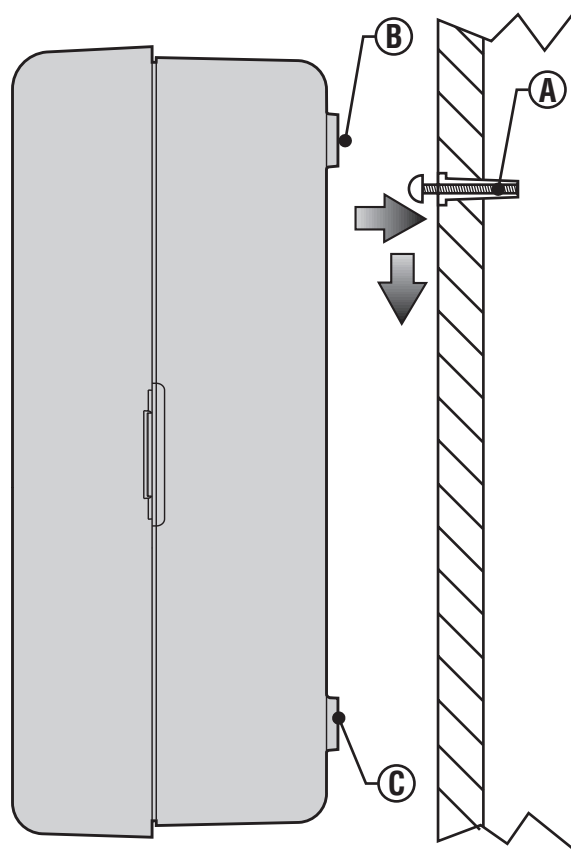

CONNECTING VALVES AND TRANSFORMER

Installation of the X-Core should only be done by trained personnel.

1. Route valve wires between the control valve location and controller.
2. At valves, attach a common wire to either solenoid wire on all valves. This is most commonly a white colored wire. Attach a separate control wire to the remaining wire of each valve. All wire connections should be done using waterproof connectors.
3. Route the valve wires through the conduit. Attach the conduit through the bottom right side of the controller.
4. Secure the white valve common wire to the C (Common) screw on the terminal strip. Attach each of the individual valve control wires to the appropriate station terminals and tighten their screws.
5. Indoor Models: route the transformer cable through the hole on the left side of the controller and connect the wires to the two screws marked 24 VAC.

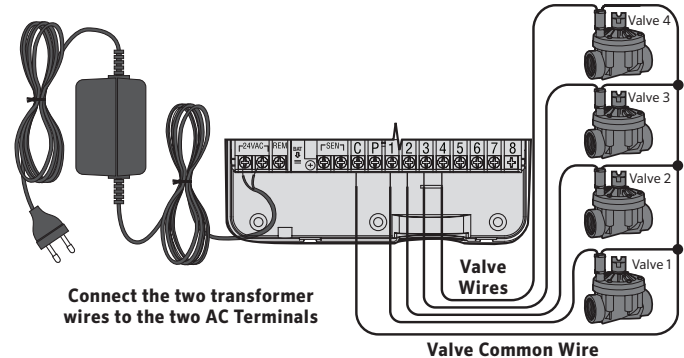

NOTE: The indoor transformer cable should not be cut. If the cable is cut, the red and white wires in the cable must be joined together, or the controller will not work.

Outdoor Models: transformer wires are already connected to the AC terminals so all that is required is to connect primary power to the junction box (see below).



NOTE: X-Core outdoor models are water and weather-resistant throughout document. Connecting the outdoor X-Core to primary AC power should only be done by a licensed electrician following all local codes. Improper installation could result in shock or fire hazard.

E High Voltage Wiring (Outdoor Model only)

1. Route AC power cable and conduit through the ½" (13 mm) conduit opening on the left side bottom of the cabinet.
2. Connect one wire to each of the two wires inside the junction box. The ground wire should be connected to the green wire. Wire nuts are provided to make these connections.
Note: For -E models only: Connect the wires to the AC terminal block inside the junction box. AC supply wires must be 14 AWG (1.85 mm) or larger with appropriate circuit breaker for the wire size. A switch or circuit-breaker shall be included in the building installation (in close proximity to the controller, within easy reach of the operator) and marked as the disconnecting device for the equipment.
3. Replace the junction box cover.

ACTIVATING THE BATTERY

After installing your X-Core, make sure to remove the battery contact insulator to allow the X-Core to keep time in the event of a power outage.

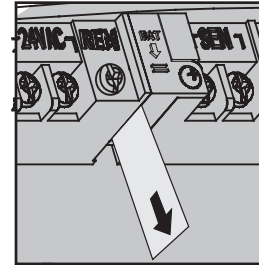

CAUTION:

Risk of explosion if battery is replaced by an incorrect type. Dispose of used batteries according to the instructions.

REPLACING THE BATTERY

A high-energy lithium battery is included with your X-Core controller. The battery allows the user to remotely program the controller without connecting AC power. It is also used to keep the current time and day during power outage conditions.

To replace the battery:

1. Remove the screw from the battery holder.
2. Slide the battery holder down to access the battery.
3. Remove and replace the new battery into the battery holder and reinstall the battery holder.

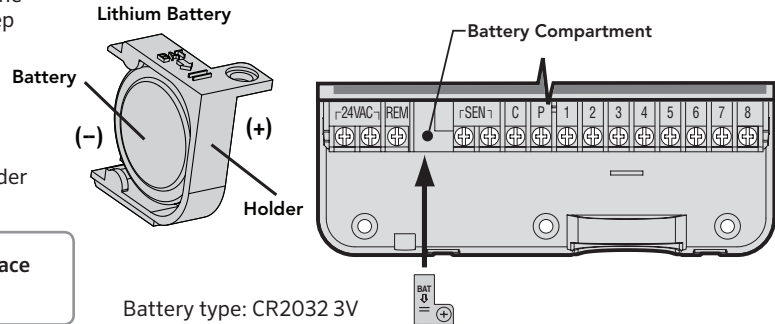

NOTE: This positive(+) side of the battery should face the inside of the battery holder.

CONNECTING A MASTER VALVE



NOTE: Complete this section only if you have a master valve installed in your irrigation system. A master valve is a “normally closed” valve installed at the supply point of the main line that opens only when the controller initiates a watering program.

1. At the Master Valve, attach the common wire to either solenoid wire of the valve. Attach a separate control wire to the remaining solenoid wire.
2. The common wire should be attached to the **C** terminal inside the controller. The other wire coming from the master valve should be attached to the **P** terminal inside the controller. Tighten each terminal screw.

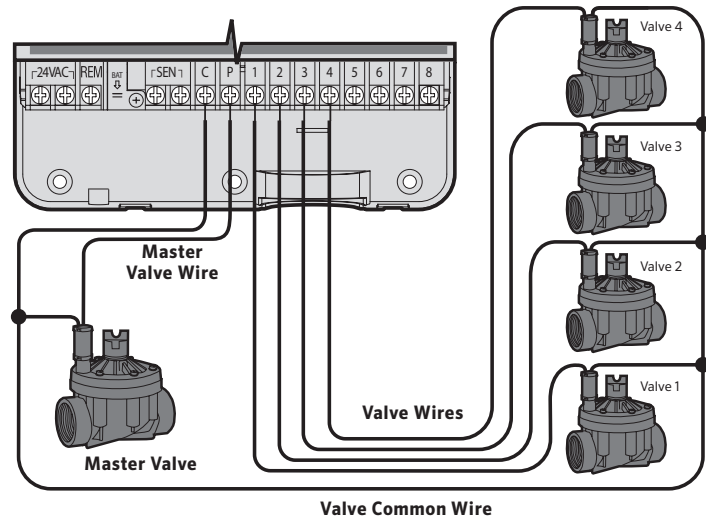

CONNECTING A PUMP START RELAY



NOTE: Complete this section only if you have a pump start relay installed. A pump start relay is a device that uses a signal from the controller to actuate a separate electrical circuit to energize a pump to provide water to your system.

The controller should be mounted at least a 15 ft (4.5 m) away from both the pump start relay and pump to minimize any potential electrical interference.

1. Route a pair of wires from the pump relay into the controller.
2. Connect a common wire to the **C** (common - typically a white wire) terminal inside the controller and connect the remaining wire from the pump start relay to the **P** (Pump) terminal.

Relay holding current draw must not exceed 0.3 A. Do not connect the controller directly to the pump or damage to the controller will result.

<http://www.hunterindustries.com/support/controllers/pump-start-relay>

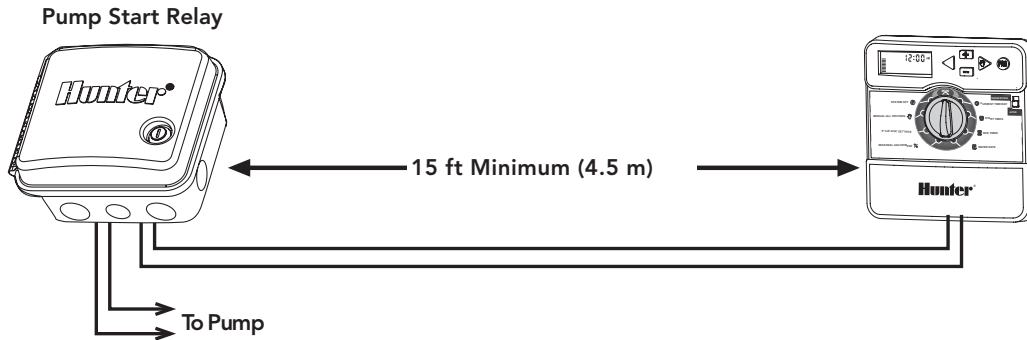

CONNECTING A HUNTER “CLIK” WEATHER SENSOR

A Hunter weather sensor or other micro-switch type weather sensors can be connected to the X-Core. The purpose of this sensor is to stop automatic watering when weather conditions dictate.

1. **Remove the metal jumper** plate that is attached across the two SEN terminals inside the controller.
2. Connect one wire to one SEN terminal and the other wire to the other SEN terminal.

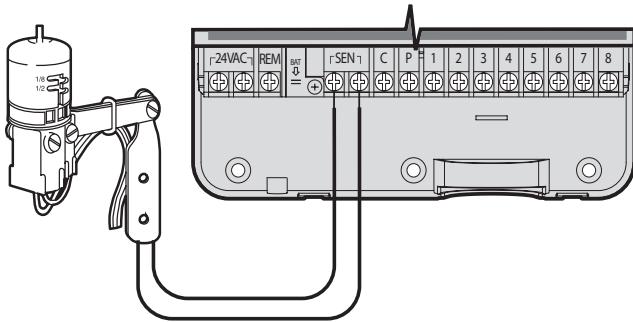

When the weather sensor has deactivated automatic watering, the OFF, and ☔ icon will appear on the display.



Testing the Weather Sensor

The X-Core provides simplified testing of a rain sensor when the sensor is wired into the sensor circuit. You can manually test proper operation of the rain sensor by running an **AUTO CYCLE** or by activating the system using the **One Touch AUTO CYCLE** (See page 22). During the Manual cycle, pressing the top spindle on the Hunter sensor will interrupt watering.

Manually Bypassing the Weather Sensor

If the rain sensor is interrupting irrigation, you can bypass it by using the bypass switch on the front of the controller. Slide the switch to the **SENSOR BYPASS** position to disable the rain sensor from the system to allow for controller operation. When using the **MANUAL - ONE STATION** function, the controller will automatically bypass sensor inputs for the selected time. Once complete, the controller will default to selected settings.



NOTE: Enabling the Sensor Bypass switch has no effect on the seasonal adjust updates from the Solar Sync sensor. It will, however, bypass the Rain Klik and Freeze - Klik functionality of the sensor.

CONNECTING A HUNTER SOLAR SYNC ET SENSOR

The X-Core is compatible with the Solar Sync and Wireless Solar Sync systems. Solar Sync is a sensor system that will automatically adjust the X-Core controller's watering schedule (based on changes in local climate condition) by using the Seasonal Adjust function. The Solar Sync uses a solar and temperature sensor to determine evapotranspiration (ET), or the rate at which plants and turf use water, and also includes Hunter Rain Klik and Freeze Klik technology that will shut down irrigation when it rains and/or during freezing conditions.



NOTE: Solar Sync will apply a default seasonal adjust value of 100% until the first full day (24 - hour period) of weather measurements have been received from the sensor.



NOTE: Enabling the Sensor Bypass switch has no effect on the seasonal adjust updates from the Solar Sync sensor. It will, however, bypass the Rain Klik and Freeze Klik functionality of the sensor.



NOTE: The Solar Sync module is not required for installation using the X-core Controller.

Installing Solar Sync Sensor

Connect the Green and Black wire from the Solar Sync Sensor to the "SEN" wiring terminals on the X-Core controller, similar to picture on page 11. It does not matter which wire connects to which terminal. Turn the dial to the "Solar Sync Settings" position. The display will initially show dashed lines



and then will show the default Region setting (3) on the left and the default Water Adjustment setting (5) on the right. Adjust the Region as needed by using the ▲ and ▼ buttons (refer to page 13 for explanation of Solar Sync Region setting). Use the ► button to advance to the right to adjust the Water Adjust setting as needed (see page 14 for explanation of Water Adjust setting).

Installing the Wireless Solar Sync

Connect the Green and Black wire from the Wireless Solar Sync Receiver to the "SEN" wiring terminals on the X-Core controller. It does not matter which wire connects to which terminal. Turn the dial to the "Solar Sync Settings" position. The display will initially show dashed lines and then will show the default Region setting (3) on the left and the default Water Adjustment setting (5) on the right. Adjust the region as needed by using the ▲ and ▼ buttons (refer to page 13 for explanation of Solar Sync Region setting). Use the ► button to advance to the right to adjust the Water Adjust setting as needed (see page 14 for explanation of Water Adjust setting).



Solar Sync Settings

Once the Solar Sync sensor is connected to the X-Core controller, two numbers will appear in the display when the dial is turned to the Solar Sync Settings position. The number on the left of the screen is the Region setting, and the number on the right on the screen is the Water Adjustment setting (as shown above).

CONNECTING A HUNTER SOLAR SYNC ET SENSOR

Region

For accurate Solar Sync measurements, the controller needs to be programmed for the average peak season ET for your region. Use the table below to determine your region.

The table will assist you in identifying the type of region you live in. There are four basic ET regions, each with descriptions of the region, along with typical ET and temperature characteristics. It is recommended that, if possible, the region be chosen based upon average July ET or peak summer ET (inches/mm per day).

Use the following table for choosing your region (reference below). You can use methods **A**, **B** or **C** to help you choose which region is best for your area:

A: Based upon the ET of your region using the **average** July ET or peak summer ET (inches/mm per day). This is the preferred option when selecting your region.

B: Based upon the temperature for your region using the **average** July or the driest month high temperature (not the highest temperature for July).

C: Based upon the general description of your region.

IF ANY OF THE CHOICES IN THE ROWS APPLY TO YOUR SITUATION, THEN THAT IS YOUR REGION SETTING CHOICE.			
	A	B	C
Region 1	If the average July ET is < 0.17" (4.3 mm) per day	If the average temperature for July is 65°–75° (18°C – 24°C)	<ul style="list-style-type: none"> • U.S. Northern States • Coastal Regions
Region 2	If the average July ET is 0.18" – 0.23" (4.6 mm – 5.8 mm) per day	If the average temperature for July is 75°– 85° (24°C – 29°C)	<ul style="list-style-type: none"> • Mountains • U.S. Northern Inland States
Region 3	If the average July ET is 0.24" – 0.29" (6.1 mm – 7.4 mm) per day	If the average temperature for July is 85° – 95° (29°C – 35°C)	<ul style="list-style-type: none"> • U.S. Southern States • Inland/High Desert
Region 4	If the average July ET is > 0.30" (7.6 mm) per day	If the average temperature for July is 95° – 105° (35°C – 41°C)	<ul style="list-style-type: none"> • Deserts

* For Southern hemisphere locations, use the month of January.

CONNECTING A HUNTER SOLAR SYNC ET SENSOR

Water Adjustment \updownarrow \pm

The Water Adjustment is a 1 to 10 scale that allows for easy adjustment of the Seasonal Adjust value from the Solar Sync ET Sensor. Upon installation of the Solar Sync ET Sensor, it is recommended that the Water Adjustment setting stay at the default value of 5. However, after installation, if you find that the seasonal adjust value is lower or higher than expected, the Water Adjustment value can be modified to modify the Seasonal Adjust output value. See Calibration/Setup on page 15 for explanation of how to use Water Adjustment scale to fine - tune seasonal adjust output value.



NOTE: If an individual zone is “wetter” or “drier” than the rest of the system, simply increase or decrease the amount of run time on the controller.

Uninstalling a Solar Sync Sensor

If a Solar Sync sensor has been installed on the X-Core controller, then the seasonal adjust value used by the controller will be calculated from the weather data supplied by the Solar Sync sensor. If it is decided that the Solar Sync sensor will no longer be used with the X-Core controller, it must be uninstalled. **If the Solar Sync sensor is not uninstalled, the controller will not allow the seasonal adjust value to be manually changed.** For example, if the seasonal adjust value shown on the controller was 50% when the Solar Sync sensor was removed, it will remain 50% until the Solar Sync sensor is uninstalled.

To uninstall the Solar Sync sensor, simply disconnect the green and black wires from the controller terminal and then turn the dial to the “Solar Sync Settings” position. The display should show dashes, indicating that the controller no longer recognizes the Solar Sync sensor for calculation of seasonal adjustment. Now the seasonal adjust value can be changed manually by turning the knob to the “Seasonal Adjust” position and using the \oplus or \ominus button to adjust the value.

CONNECTING A HUNTER SOLAR SYNC ET SENSOR

Calibration/Setup

After Solar Sync has been installed and programmed, it is recommended to allow the system to run for a few days at the initial setting. Because of the variety in site conditions (including sensor location, amount of direct sunlight available to the sensor, reflective heat from surrounding structures, etc), **the initial setting may require adjustment in order to arrive at the desired performance.** The calibration of the Solar Sync to a particular site can easily be accomplished by adjusting the Region and/or Water Adjustment settings. The instructions below outline this process:

1. Install Solar Sync sensor
2. Program Region and allow system to operate at initial setting for a minimum of 3 days (see page 13 for instructions on how to determine proper Region setting).
3. Observe the Seasonal Adjust on the controller. If the Seasonal Adjust amount appears to be lower or higher than expected for that time of year, the Solar Sync settings need to be adjusted.
 - a. **Seasonal Adjust too low:** Turn the dial to the Solar Sync settings position. Increase the value on the Water Adjustment scale (10 is max). Once the setting is changed, the controller will immediately be updated with the new Seasonal Adjust %. Increase the Water Adjustment setting until the desired Seasonal Adjust % is shown. **If you max out the Water Adjustment scale at 10 and still require more Seasonal Adjust, move down to the next lower Region (from Region 4 to 3, for example).**
 - b. **Seasonal Adjust too high:** Turn the dial to the Solar Sync settings position. Decrease the value on the Water Adjustment scale (default setting is 5). Once the setting is changed, the controller will immediately be updated with the new Seasonal Adjust %. Decrease the Water Adjustment setting until the desired Seasonal Adjust % is shown. **If you minimize the Water Adjustment scale down to 1 and still require a reduction in Seasonal Adjust, move up to the next Region (from Region 2 to 3, for example).**

Station Run Times: It is important to understand that Solar Sync provides a global seasonal adjustment to the controller. This means that all station run times will be modified by the seasonal adjust percentage shown. When programming the controller, the run times should be entered that represent peak season watering schedules. If the Solar Sync is adjusting to the appropriate seasonal adjust value but the run time for a particular station appears to be too long/short, adjust the station run time in the controller program.

SOLAR SYNC DELAY FEATURE

Solar Sync Delay for X-CORE®

The delay feature is accessible only after the installation of the Solar Sync. The Solar Sync Delay feature allows the user to postpone seasonal adjustment changes from being made by Solar Sync for up to 99 days.

While the Solar Sync Delay is active, the Solar Sync will continue to collect and store data.

Operation:

To access the Solar Sync Delay setting:

1. Place the dial in the RUN position; press and hold the **+** button, rotate the dial to the Solar Sync position then release the **+** button. The following screen will be presented: **d:XX** (where d indicates days and **XX** indicates the number of days to be delayed).
2. Press the **+** or **-** button to increase/decrease the number of days the delay should run. Once the desired number of days is displayed, move the dial back to the RUN position to activate the delay.

To change the existing Delay days setting:

1. Open the Solar Sync Delay menu by pressing the **+** button and rotating the dial to Solar Sync Settings and release the **+** button.
2. Use the + or - keys to modify the number of days until desired numbers of delay days is displayed. (Setting the days to 00 turns Solar Sync Delay to **OFF**.)
3. Return the dial to the **RUN** position for the changes to take effect.

While Solar Sync Delay is active, the Solar Sync will continue to gather weather information and calculate the Seasonal Adjust Value. The updated seasonal adjust will be applied once the Solar Sync Delay days reach 00.



NOTE: The number of days remaining will not be displayed on the **RUN** screen. To check if the Delay feature is active, open the Solar Sync Delay menu and check the days displayed. If 1 or more days are displayed, then Solar Sync Delay is active, if 00 is displayed, then Solar Sync Delay is not active.

CONNECTING A HUNTER REMOTE

Connecting to a Hunter Remote (not included)

The X-Core Controller is compatible with Hunter Remote Controls (not included). The SmartPort® wiring harness (included with all Hunter Remotes) allows for fast and easy use of the Hunter controls. The Hunter remotes make it possible for you to operate the system without having to walk back and forth to the controller.

To install the SmartPort connector

1. Install a ½" Female threaded "Tee" in the field wiring conduit (not included) approximately 12 inches below the X-Core.
2. Feed the red, white, and blue wires of the harness through the base of the "Tee" and into the wiring compartment as shown.
3. Screw the SmartPort harness

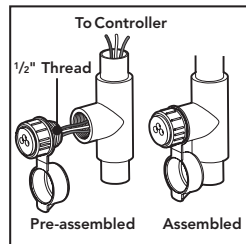

NOTE: P/N 258200 can be used as an alternate method to mount the SmartPort connector.

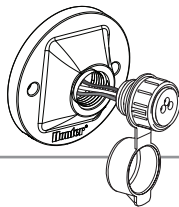

POWER FAILURES

Due to the possibility of power failures, the controller has non-volatile memory. Programmed information will never be lost due to a power outage. The lithium battery will keep the correct time without AC power. Normal watering will resume when AC power is restored.

housing into the "Tee" as shown.

4. Attach the red, white, and blue SmartPort wires to the controller terminal as shown below:

- Red wire to left side "24 VAC" terminal
- White wire to right side "24 VAC" terminal
- Blue wire to "REM" terminal

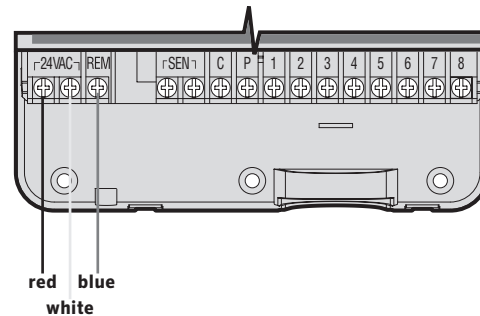

PROGRAMMING THE CONTROLLER

The X-Core display shows the time and day when the controller is idle. The display changes when the dial is rotated to indicate the specific programming information to enter. When programming, the flashing portion of the display can be changed by pressing the **+** or **-** buttons. To change something that is not flashing, press the **◀** or **▶** buttons until the desired field is flashing.

Three programs A, B, and C, each with the ability to have four daily start times, permit plants with different watering requirements to be separated on different day schedules.

Setting the Date and Time 🕒

1. Turn the dial to the **CURRENT TIME/DAY** position.
2. The current year will be flashing. Use the **+** or **-** buttons to change the year. After setting the year, press the **▶** button to proceed to setting the month.
3. The month and day will be in the display. The month will be flashing and the **1-12** icon will be displayed. Use the **+** or **-** buttons to change the month. Press the **▶** button to proceed to setting the day.
4. The day will be flashing and the **1-31** icon will be displayed. Use the **+** or **-** buttons to change the day. Press the **▶** button to proceed to setting the time.
5. The time will be displayed. Use the **+** and **-** buttons to select AM, PM, or 24 hour. Press the **▶** button to move to hours. Hours will be flashing. Use the **+** and **-** buttons to change the hour shown on the display. Press the **▶** button to move to minute. Minutes will be flashing. Use the **+** and **-** buttons to change the minutes shown on the display. The date, day, and time have now been set.



NOTE: A basic programming rule is that whatever symbol or character is flashing will be the item programmed. For instance, if the hour is flashing when setting the time, the hour can be changed or programmed. For illustration purposes in this manual, flashing characters are in GRAY type.

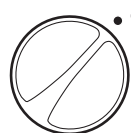

🕒 CURRENT TIME/DAY

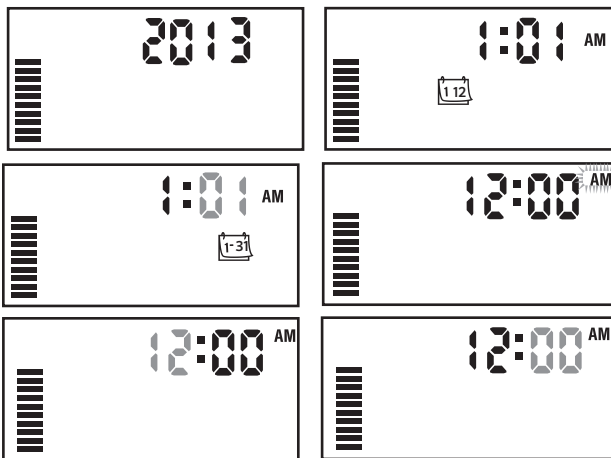

PROGRAMMING THE CONTROLLER

Setting the Program Start Time(s)

1. Turn the dial to the **START TIMES** position.
2. The factory preset is set on program A. If necessary, you can select program B, or C by pressing the **PROG** button.
3. Use the **+** or **-** button to change the start time. (The start times advance in 15 - minute increments).
4. Press the **▶** button to add an additional start time, or **PROG** button for the next program.

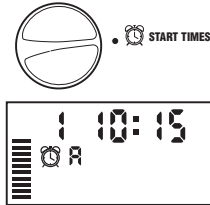

NOTE: One start time will activate all stations sequentially in that program. This eliminates the need to enter each station's start time. Multiple start times in a program can be used for separate morning, afternoon, or evening watering cycles. Start times may be entered in any order. The X-Core will automatically sort them.



Eliminating a Program Start Time

With the dial set to **START TIMES** position, push the **+** or **-** button until you reach 12:00 AM (Midnight). From here, push the **-** button once to reach the OFF position.

Press the right arrow to eliminate a second start time.

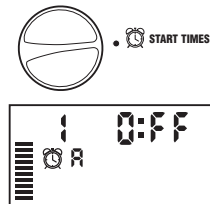

Setting Station Run Times

1. Turn the dial to **RUN TIMES** position.
2. The display will show the last program selected (A, B, or C), the station number selected, **R** icon, and the station will be flashing. You can switch to another program by pressing the **PROG** button.
3. Use the **+** or **-** button to change the station run time on the display. You can set the run times from 0 to 4 hours.
4. Press the **▶** button to advance to the next station.

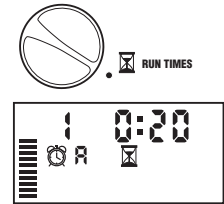

Setting Days To Water

1. Turn the dial to the **WATER DAYS** position.
2. The display will show the last program selected (A, B, or C). You can switch to another program by pressing the **PROG** button.
3. The controller will display the seven days of the week (MO, TU, WE, TH, FR, SA, SU). Each day will have a **☉** icon or a **☾** icon above the day. The **☉** icon would represent an "On" water day, while a **☾** icon would represent an "Off" watering day.



Selecting Specific Days of the Week to Water

1. With the **☉** cursor on a specific day (the cursor will always start with MO), press the **+** button to activate a particular day of the week to water. Press the **-** button to cancel watering for that day. After pressing a button the cursor automatically advances to the next day.
2. Repeat step 1 until all desired days have been selected. The selected days will show a **☉** to indicate their status is ON. The last **☉** is the last day of watering for that program.

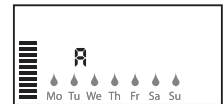

PROGRAMMING THE CONTROLLER

Selecting Odd or Even Days to Water

This feature uses numbered day(s) of the month for watering instead of specific days of the week (odd days: 1st, 3rd, 5th, etc.; even days: 2nd, 4th, 6th, etc.).

1. Press the ► right arrow until the cursor is over **SU**.

2. Press the right arrow one more time, and **Odd** will appear, with the [raindrop icon]. If **Odd** is desired, turn the dial back to the **Run** position.



3. If even day watering is desired, press the [] button once. The [] icon and **EVEN** will be displayed. You can move back and forth from **ODD** to **EVEN** by pressing the [] buttons.



NOTE: The 31st of any month and February 29th are always "off" days if Odd watering is selected.

Selecting Interval Watering

With this option you can select interval watering from 1 to 31 days.

1. With the cursor on **EVEN** or **ODD**, press the ► button once and the  icon will appear and a 1 flashing in the display. Interval watering schedule appears on the display.

2. Press the [] or [] button to select the number of days between watering days (from 1 to 31 days). This is called the interval.



The controller will water the selected program at the next start time and will then water at the interval programmed.



Note: To exit Interval Mode (if it is not desired) press the left arrow button until the Day of Week display is shown again.

Setting Event Day(s) Off

The X-Core allows you to program a No Water Day(s). This feature is useful to inhibit watering on specific day(s). For example, if you always mow the lawn on Saturdays, you would designate Saturday as a **No Water Day** so that you are not mowing wet grass.

1. Turn the dial to the **WATER DAYS** position.
2. Enter an interval watering schedule as described on page 19.
3. Press the ► button to scroll to the **No Water Days** at the bottom of the display. **MO** will be flashing.
4. Use the ► button until the cursor is at the day of the week you wish to set as a No Water Day.
5. Press the [] button to set this day as a no water day. The [] will illuminate over this day.
6. Repeat steps 4 and 5 until all desired event day(s) are off.



NOTE: You also have the option in the interval watering schedule to program Odd or Even days off.

Automatic Watering

After programming the X-Core, set the dial to the **RUN** position to enable automatic execution of all selected watering programs and start times.

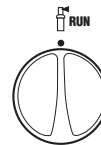

System Off

Valves currently watering will be shut off after the dial is turned to the **SYSTEM OFF** position for two seconds. All active programs are discontinued and watering is stopped. To return the controller to normal automatic operation, simply return the dial to the **RUN** position.



SYSTEM OFF 



PROGRAMMING THE CONTROLLER

Programmable Rain Off

This feature permits the user to stop all programmed waterings for a designated period from 1 to 7 days. At the end of the programmed rain off period, the controller will resume normal automatic operation.

1. Turn the dial to the **SYSTEM OFF** position. Wait for **OFF 1** to be displayed.
2. Press the **+** button as many times as needed to set the number of days off (up to 7 days).
3. Turn the dial back to the **RUN** position at which **OFF**, a number, the  and  icons will be displayed.

The days off remaining will decrease at midnight each day. When it goes to zero, the display will show normal time of day and normal irrigation will resume at the next scheduled start time.

Seasonal Adjustment %

Seasonal Adjustment is used to make global run time changes without reprogramming the entire controller. To use the Seasonal Adjustment feature:

1. Turn the dial to the **SEASONAL ADJUSTMENT** position.
2. The display will now show a flashing number followed by a %, as well as the bar graph which always remains on the display. Press the **+** or **-** button to

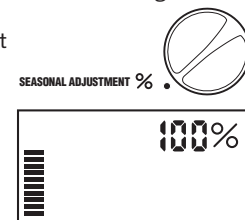
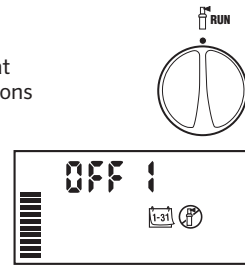
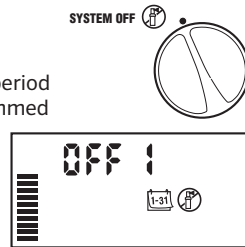

adjust the percentage of the seasonal adjustment. Each bar on the graph represents 10%. This feature can adjust the controller from 10% to 150% of the original program.

To view the adjusted run times, simply turn the dial to the **RUN TIMES** position, the displayed run time will be updated accordingly as the seasonal adjustment is made.



NOTE: The controller should always be initially programmed in the 100% position.

When using a Hunter “Clik” weather sensor, the Seasonal Adjustment value can be adjusted as described.

When using the Solar Sync ET sensor, the Seasonal Adjustment value is automatically updated daily based on the Solar Sync sensor. The Solar Sync ET sensor measures weather patterns, determines the optimal Seasonal Adjustment value, and then updates the controller on a daily basis. This value can be overridden manually by pressing the **+** or **-** buttons to the desired Seasonal Adjustment value. **However, it is important to understand that the manually adjusted Seasonal Adjustment value will be replaced at midnight by the new updated value from the Solar Sync sensor.**

To revert to a manually adjusted mode, the Solar Sync sensor must be uninstalled. See page 14 for instructions on how to uninstall the Solar Sync sensor.

Manually Run a Single Station

PROGRAMMING THE CONTROLLER

1. Turn dial to **MANUAL - ONE STATION** position.
2. Station run time will flash in the display. Use the ► button to move to the desired station. You may use the + or - button to select the amount of time for a station to water.
3. Turn the dial clockwise to the RUN position to run the station (only the designated station will water, then the controller will return to automatic mode with no change to the previously set program). Also see **One - Touch Manual Start and Advance**.

MANUAL-ONE STATION



One - Touch Manual Start and Advance







You can also activate all stations to water without using the dial.

1. Hold down the ► button for 2 seconds.
2. This feature automatically defaults to program A. You can select program B or C by pressing the PRG button.
3. The station number will be flashing. Press the ► button to scroll through the stations and use the + or - button to adjust station run times. (If no buttons are pressed for a few seconds during step 2 or 3, the controller will automatically begin watering).
4. Press the ► button scroll to the station you wish to begin with. After a 2 - second pause, the program will begin. At any time during the manual cycle, you can use the ◀ or ► buttons to navigate from station to station manually.

ADVANCED FEATURES



Programmable Sensor Override

The X-Core allows the user to program the controller so that the sensor disables watering on only desired stations. For example, patio gardens that have pots under overhangs and roofs may not receive water when it rains and will continue to need to be watered during periods of rain. To program sensor override:

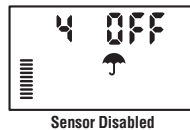
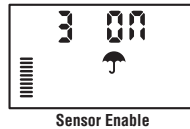
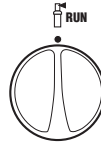
1. Turn the dial to the **RUN** position.
2. Press and hold the  button down while turning the dial to **START TIMES** position.
3. Release the  button. At this point, the display will show the station number, ON, and the  icon, will be flashing.
4. Press the  or  button to enable or disable the sensor for the station shown.
ON = Sensor enabled
(will suspend irrigation)
OFF = Sensor disabled (will allow watering)
5. Use the  or  buttons to scroll to the next station that you would like to program the sensor override.





NOTE: The controller default is for the sensor to disable watering on all zones when rain occurs.

When the X-Core receives an input from the sensor to disable watering, the display will indicate those stations that have been programmed to override the sensor. A station that is running in the sensor override mode will flash the  and  icons alternately.





Test Program of All Stations

The X-Core allows the user a simplified method for running a test program. This feature will operate each station in numerical sequence, from the lowest to the highest.

1. With the dial in the **RUN** position, press and hold the  button. The station number will be displayed and the time will be flashing for two seconds.
2. Use the  or  buttons to set the run time from 1 to 15 minutes. The run time needs to be entered only once.
3. After a - 2 second pause, the test program will start.

Hunter Quick Check Diagnostics

This feature allows you to quickly diagnose wiring problems with your controller. Instead of having to check each field wiring circuit for potential problems, you can use the Hunter Quick Check circuit test procedure. To initiate the Quick Check test procedure:

1. Press the , , , and  buttons simultaneously. In the standby mode, the LCD will display all segments.
2. Press the  button once to begin the Quick Check procedure. Within seconds, the system searches all stations for detecting any circuit problems. When a field wiring short is detected, an ERR symbol preceded by the station number will momentarily flash on the display. After the Quick Check completes running the circuit diagnostic procedure, the controller returns to the automatic watering mode.

ADVANCED FEATURES

Easy Retrieve® Program Memory

The X-Core is capable of saving the preferred watering program into memory for retrieval at a later time. This feature allows for a quick way of resetting the controller to the original programmed watering schedule.

To save the program into the memory

1. With the dial in the **RUN** position, press and hold the **+** and **PRG** buttons for 5 seconds. The display will scroll three segments from left to right across the display indicating the program is being saved into memory.
2. Release the **+** and **PRG** buttons.

To retrieve a program that was previously saved into memory.

1. With the dial in the **RUN** position, press and hold the **-** and **PRG** buttons for 5 seconds. The display will scroll three segments from right to left across the display indicating the program is being saved into memory.
2. Release the **-** and **PRG** buttons.

Programmable Delay Between Stations

This feature allows the user to insert a delay between stations when one station turns off and the next one turns on.

1. Start with the dial in the **RUN** position.
2. Press and hold the **-** button down while turning the dial to the **RUN TIMES** position.
3. Release the **-** button. At this point the display will show a delay time for all stations in seconds, which will be flashing.
4. Press the **+** or **-** buttons to increase or decrease the delay time between 0 seconds to 4 hours.
5. Return the dial to the **RUN** position.

Resetting Controller / Clearing Controllers Memory

If you feel you have misprogrammed the controller, there is a process that will reset the memory to the factory defaults and erase all programs and data that have been entered into the controller.

1. Press and hold the **PRG** button.
2. While holding the **PRG** button, press and release button on the right - hand side of the controller.
3. Continue holding **PRG** button until time 12:00 am is displayed (this takes about 8 seconds).

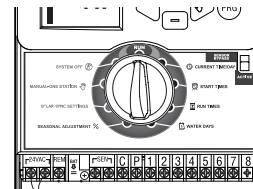

Reset

CLIK DELAY INSTRUCTIONS

Clik Delay Feature

This feature allows the user to delay programmed waterings for a designated period (from 1-7 days) AFTER a Clik Event ends. At the end of the Programmed Clik Delay period, the controller will resume normal automatic irrigation.

1. Turn the dial to the **RUN** Position
2. Press and hold the **+** button for 3 seconds, then turn the dial to the **OFF** position
3. Release the **+** button. The display will show the programmable Clik Delay.

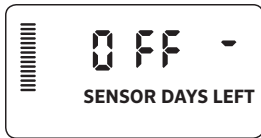

4. Press the **+** button to set Clik Delay duration (from 1 to 7 days).
5. Return the dial to the **RUN** position. Clik Delay is set.

After a Clik Event ends (rain sensor changes from wet to dry) the Clik Delay feature will become active and the screen will display Clik Delay duration. The day countdown will occur 24 hours after the start of Clik Delay.



An active Clik Delay can be cancelled by turning the dial to the **OFF** position, waiting for OFF to stop flashing, then turning the dial back to the **RUN** position.

Any station that is set to override sensor, as well as Lighting Programs, will operate during a Clik Delay event.



NOTE: Use caution when using the programmable Clik Delay feature with Hunter Wind-Clik®, Freeze-Clik®, Soil-Clik, and freeze component of Solar Sync and Rain/Freeze Clik as the Clik Delay will become active AFTER Clik Event from these devices.

HIDDEN FEATURES

Program Customization

The X-Core is factory configured with three independent programs (**A, B, C**) with four start times each for different plant type requirements. The X-Core can be customized to display only one program and one start time, hiding extra unneeded programs and start times to ease programming.

1. Start with the dial in the **RUN** position.
2. Press and hold the - button. Turn the dial to the **WATER DAYS** position.
3. Release the - button.
4. Use the + and - buttons to change program modes.

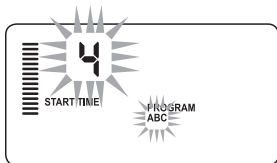

Normal Mode
(3 programs / 4 start times)

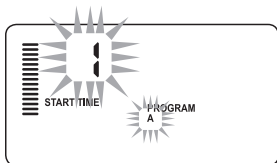

Limited Mode
(1 program / 1 start time)

HIDDEN FEATURES (CONTINUED)

Cycle and Soak

The Cycle and Soak feature allows you to split a station's run time into more usable, shorter watering durations. This feature is useful when applying water to slopes and tight soils because it automatically applies water more slowly, helping to prevent runoff from occurring. You should enter the Cycle time as a fraction of the station's watering time, and the Soak time as the minimum number of minutes required before watering can occur again for the next Cycle. The total number of cycles is determined by taking the total programmed station run time and dividing it by the Cycle time.

Accessing the Cycle and Soak Menu:

The Cycle and Soak feature is accessed by placing the dial in the **RUN** position, pressing and holding the **+** button for 3 seconds; while holding the **+** button rotate the dial to the **RUN TIME** dial position, then release the button.

Setting the Cycle Time:

Initially Station 1 will be displayed. To access other stations, press the ◀ or ▶ button.

Once the desired station is displayed, use the **+** or **-** button to increase or decrease the Cycle time. The user can set the time from 1 minute to 4 hours in 1 - minute increments or to **OFF** if no Cycle is desired.



NOTE: Before 1 hour, only minutes are displayed (e.g. 36). At 1 hour or above, the display will change to include the hour digit (e.g. 1:13 and 4:00).
If a station's Run Time is less than or equal to the Cycle time, then no Cycle will be applied.

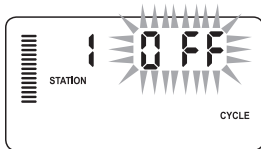

Example of Cycle screen upon entering

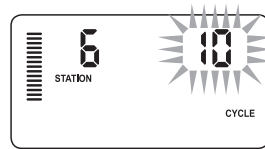

Example of Cycle screen with only minutes

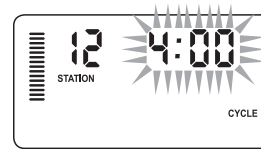

Example of Cycle screen with hours included

HIDDEN FEATURES (CONTINUED)

Accessing the Soak Menu:

Once the desired Cycle times for each station have been programmed, the Cycle time can be accessed by pressing the **PRG** button.

The station will remain the same as was previously displayed under the Cycle time (i.e. if station 2 is displayed in the Cycle menu then Station 2 will be displayed upon pressing the **PRG** button).



NOTE: The Soak menu cannot be accessed without a programmed Cycle time.

Setting the Soak Time:

To access the other stations, press the **◀** or **▶** button.



NOTE: When changing the stations, if a station without a Cycle time is encountered, the screen will revert back to the Cycle time. Move to the next station with a Cycle Time and press the **PRG** button to return.

Once the desired station is displayed, the user can use the **+** or **-** button to increase or decrease the Soak time. The user can set the Soak time from 1 minute to 4 hours in 1 - minute increments.



NOTE: Before 1 hour, only minutes are displayed (e.g. 36). At 1 hour or above, the display will change to include the hour digit (e.g. 1:13 and 4:00).



Example of Soak screen with only minutes

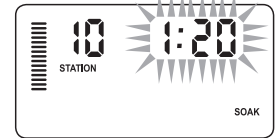

Example of Soak screen with hours included

Cycle and Soak Situations:

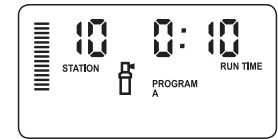

Station 1 requires 20 minutes of watering, but after 5 minutes, runoff occurs. However, after 10 minutes all the water is absorbed. The solution would be to program 20 minutes for the station run time, 5 minutes for the Cycle time, and 10 minutes for the Soak time.

The soak time is a minimum amount. The soak time may be longer amount depending on the remaining run times.





Station 10 cycle running

TROUBLESHOOTING GUIDE

Problem	Causes	Solutions
The controller is continuously watering	Too many start times have been programmed	Only one start time is necessary to activate a program (refer to Setting the Program Start Times on page 18)
There is no display	Check AC power wiring	Correct any errors
The display reads “No AC”	There is no AC power present (the controller is not receiving any power)	Check to see if the transformer is properly installed
Display reads “Off,   ”	The rain sensor is interrupting irrigation or the sensor jumper has been removed	Slide the rain sensor bypass switch to the BYPASS position to bypass the rain sensor circuit, or reinstall the jumper
Rain sensor will not shut off the system	<ul style="list-style-type: none"> • Defective rain sensor • Jumper was not removed when sensor was installed • Stations have been programmed to override the sensor 	<ul style="list-style-type: none"> • Verify operation of rain sensor and proper wiring • Remove jumper from the sensor terminals • Reprogram the sensor override to enable the sensor (see page 11)
Frozen display, or showing incorrect information	Power surge	Reset the controller per page 24 “Clearing Controller Memory/Resetting the Controller”
Display shows “ERR” with a number (1 to 8)	Short in the valve wiring circuit, or faulty solenoid on the station number indicated	Check wire circuit or solenoid for the valve number indicated. Repair short or replace solenoid. Press any button to clear the “ERR” from the display
Display shows “P ERR”	<ul style="list-style-type: none"> • Faulty pump relay or master valve wiring • Incompatible or defective relay or solenoid • Undersized wire to the pump relay or master valve 	<ul style="list-style-type: none"> • Check wiring to relay or master valve solenoid. Press any button to clear the “P ERR” from the display • Check electrical specification for the pump relay. Do not exceed controller’s electrical rating. Replace if defective • Replace wire with larger gauge wire

TROUBLESHOOTING GUIDE

Problem	Causes	Solutions
Display shows a station is running but the  and  icons are flashing	The sensor is interrupting irrigation, however the station has been programmed to override the sensor	Check the sensor override status (see page 23)
Automatic irrigation does not start at the start time and controller is not in the System Off mode	<ul style="list-style-type: none"> • AM/PM of time of day not set correctly • AM/PM of start time not set correctly • Start Time is disabled (set for Off) • Controller is not receiving AC power 	<ul style="list-style-type: none"> • Correct AM/PM of time of day • Correct AM/PM of start time • See Setting Program Start Times (see page 18) • Check AC power connections
The display shows dashes when the dial is in the Solar Sync Settings position	<ul style="list-style-type: none"> • The Solar Sync sensor is not connected to the controller • The Solar Sync sensor wires may have a break in them or a bad connection 	Connect the Solar Sync to the “SEN” positions on the wiring terminal. The display will then show the Region and Water Adjustment setting.
Run times for a particular station are too short/too long when using a Solar Sync sensor	Program Run Time too long/short	Solar Sync provides a global seasonal adjustment to the controller. If a particular station has run times too long or too short, make the appropriate adjustment to the program in the controller. Make sure to change seasonal adjust back to 100% before making changes to program run times. Do this by turning the dial to the Seasonal Adjust position and increasing/decreasing the value to 100%.
Seasonal Adjust seems low	<ul style="list-style-type: none"> • Region too high • Water Adjustment too low • Location of sensor does not allow for full sun 	Increase the value on the Water Adjustment scale (the default setting is 5). If you max out on the Water Adjustment scale at 10 and still require more seasonal adjustment, move down one Region (from 4 to 3, for example) and start at Water Adjustment setting 5. Solar Sync will immediately update the Seasonal Adjust on the controller. If it is still too high, repeat the adjustment until the desired seasonal adjust is showing on the controller.

TROUBLESHOOTING GUIDE

Problem	Causes	Solutions
Seasonal Adjust seems high	<ul style="list-style-type: none"> • Region too low • Water Adjustment setting too high 	Decrease the value of the Water Adjustment setting. If you minimize the Water Adjustment scale at 1 and still require reduced seasonal adjustment, move up one Region (from 2 to 3, for example) and start at Water Adjustment setting 5. Solar Sync will immediately update the Seasonal Adjust on the Controller. If it is still too high, repeat the adjustment until the desired seasonal adjust is showing on the controller.
Solar Sync still sending Seasonal Adjust when Controller Bypass switch is in the “Bypass” position	Solar Sync’s automated Seasonal Adjustment cannot be deactivated by the Bypass switch. The Bypass switch only controls the Rain/Freeze shutoff function of the Solar Sync.	

SPECIFICATIONS

Operating Specifications

- Station Run Times: 0 to 4 hours in 1-minute increments
- 3 Independent Watering Programs
- Start Times: 4 per day per program for up to 12 daily starts
- Watering Schedule: 365-day calendar, interval watering, odd/even watering
- AM/PM, 24-hour clock
- Simple manual operation
- Sensor override by station
- Programmable rain delay (1 to 7 days)
- Manual Seasonal Adjustment (10% to 150%)
- Automatic Seasonal Adjustment using Solar Sync sensor
- Sensor bypass switch
- X-Core-x00i for indoor use. X-Core-x00 for outdoor use
- Sea level to 6500 ft (2000 m) at -13° F to 140° F (-25° C to 60° C)

Dimensions

Indoor Cabinet

- Height: 6.5" (16.5 cm)
- Width: 5.75" (14.6 cm)
- Depth: 2" (5 cm)

Outdoor Cabinet

- Height: 8.625" (22 cm)
- Width: 7" (17.8 cm)
- Depth: 3.75" (9.5 cm)

Electrical Specifications

- Transformer input 120 VAC $\pm 10\%$ 60 Hz (230 VAC $\pm 10\%$ 50/60 Hz International Models)
- Transformer Output: 24 VAC 1.0 amp
- Station Output: 0.56 amps per station
- Maximum Output: 0.90 amps (includes master valve)
- Battery: 3 V Lithium (included) used for remote programming and backup timekeeping. Use CR2032 3-volt.
- Electronic short circuit protection
- Non-volatile memory for program data
- UL Listed
- Model X-Core-x00 has an IP2X Rating
- Clean only with a cloth dampened with mild soap and water

Explanation of Symbols

~ = AC

 = Consult Documentation

 = Hazardous Voltages Present

 = Ground

CERTIFICATE OF CONFORMITY TO EUROPEAN DIRECTIVES

FCC Notice

This equipment generates, uses, and can radiate radio frequency energy and, if not installed and used in accordance with the manufacturer's instruction manual, may cause interference with radio and television reception. This equipment has been tested and found to comply with the limits for a Class B digital device, pursuant to part 15 of the FCC Rules. Operation is subject to the following two conditions:











- 1) This device may not cause harmful interference.
- 2) This device must accept any interference received, including interference that may cause undesired operation.

Notice: The FCC regulations provide that changes or modifications not expressly approved by Hunter Industries could void your authority to operate this equipment. These limits are designed to provide reasonable protection against harmful interference in a residential installation. However, there is no guarantee that interference will not occur in a particular installation. If this equipment does cause harmful interference to radio or television reception, which can be determined by turning the equipment off and on, the user is encouraged to try to correct the interference by one or more of the following measures:









- Reorient or relocate the receiving antenna.
- Increase the separation between the equipment and receiver.
- Connect the equipment into an outlet on a circuit different from that to which the receiver is connected.
- Consult the dealer or an experienced radio/TV technician for help.



INHALTSVERZEICHNIS

X-CORE BESTANDTEILE	2	Einstellen der Berechnungstage 	19
WANDMONTAGE DES STEUERGERÄTES	6	Auswählen von einzelnen Tagen der Woche	20
ANSCHLUSS VON VENTILEN UND TRAFU	7	Einstellen von ungeraden oder geraden Berechnungstagen.....	20
AKTIVIEREN DER BATTERIE	8	Intervallbewässerung 	20
AUSTAUSCH DER BATTERIE	8	Abschalten der Bewässerung an bestimmten Tagen	20
ANSCHLUSS EINES HAUPTVENTILS	9	Automatische Bewässerung 	21
ANSCHLUSS EINES PUMPENSTARTRELAIS	10	Systemunterbrechung 	21
ANSCHLUSS EINES REGENSENSORS	11	Programmierbare Regenunterbrechung	21
Testen des Regensensors.....	11	Saisonale Anpassung %	21
Manuelle Umgehung des Regensensors	11	Manueller Start einer einzelnen Sektion 	22
SOLAR SYNC-EINSTELLUNGEN	12	„One Touch“ - Manueller Start und Weiterschaltung.....	22
Installieren des Solar Sync-Sensors	12	FORTGESCHRITTENE FUNKTIONEN	23
Installieren des Wireless Solar Sync	12	Programmierbare Abschaltung des Sensors	23
Solar Sync-Einstellungen	12	Überprüfen der Programme aller Sektionen.....	23
Region 	13	Hunter Quick Check™ Diagnose	23
PROGRAMMIEREN DES SOLAR-SYNC-MODULS	13	Easy Retrieve™ Programmspeicher.....	24
Bewässerungseinstellung 	14	Programmierbare Verzögerungszeit zwischen den Sektionen	24
Ausbau eines Solar Sync-Sensors.....	14	Löschen des Speichers/ Reset des Steuergeräts.....	24
Kalibrier-/Einrichtungszeitraum.....	15	Click-Verzögerung Anweisungen	25
Solar Sync Verzögerungsfunktion	16	Programm anpassen	26
Verbindung mit einer Hunter-Fernbedienung (nicht im Lieferumfang enthalten)	17	Zyklus- und Sickerphasen	27
SO INSTALLIEREN SIE DEN ANSCHLUSS DES SMARTPORT®	17	FEHLERSUCHE	28
STROMAUSFALL	17	SPEZIFIKATIONEN	31
PROGRAMMIERUNG DES STEUERGERÄTS	18	Ausstattungsmerkmale	31
Einstellen von Datum und Uhrzeit 	18	Elektrische Spezifikationen	31
Einstellen einer programmierten Startzeit 	18	Erläuterung der Symbole	31
Löschen einer programmierten Startzeit.....	19	BESTÄTIGUNG DER ENTSPRECHUNG EUROPÄISCHER RICHTLINIEN	32
Einstellen der Berechnungsdauer 	19		

X-CORE BESTANDTEILE

A LCD Anzeige		
1	 Laufzeit	Mit dieser Funktion können Sie die Laufzeit jeder Ventilsektion von 1 Minute bis 4 Stunden einstellen
2	 Startzeit	Mit dieser Funktion können Sie 1 bis 4 Startzeiten in jedem Programm einstellen
3	Sektionsnummer	Zeigt die z.Zt. gewählte Sektionsnummer an
4	Programm	Zeigt, welches Programm gerade bearbeitet wird (A, B, C)
5	Wochentag	Zeigt Wochentag an
6	 Intervallbewässerung	Zeigt bei der Programmierung des aktuellen Datums den Monat an
7	Ungerade/gerade Berechnungstage	Zeigt an, ob ungerade oder gerade Berechnungstage ausgewählt wurden
8	Blinkender Regner	Zeigt an, dass gerade bewässert wird
9	 Aus	Automatikbetrieb wird unterbrochen. Dient auch zum Einstellen der programmierbaren „Regenunterbrechung“, mit der die Beregnung für einen Zeitraum von 1 bis 7 Tagen unterbrochen wird
10	 Regenschirm	Symbol erscheint, wenn der Regensensor aktiv ist
11	% Saisonale Anpassung	Ermöglicht die jahreszeitliche Anpassung der Beregnungsdauer, ohne dass eine Neuprogrammierung des Steuergerätes erforderlich ist. Die Balken auf der linken Seite ermöglichen eine schnelle visuelle Überprüfung des Prozentsatzes der saisonalen Anpassung
12	 Tropfen	Gibt die Tage an, an denen bewässert wird
13	 Durchgestrichener Tropfen	An diesen Tagen wird NICHT bewässert
14	 Kalender	Zeigt an, wenn ein Intervall programmiert wurde. Das Symbol erscheint auch bei Programmierung des aktuellen Tages

X-CORE BESTANDTEILE

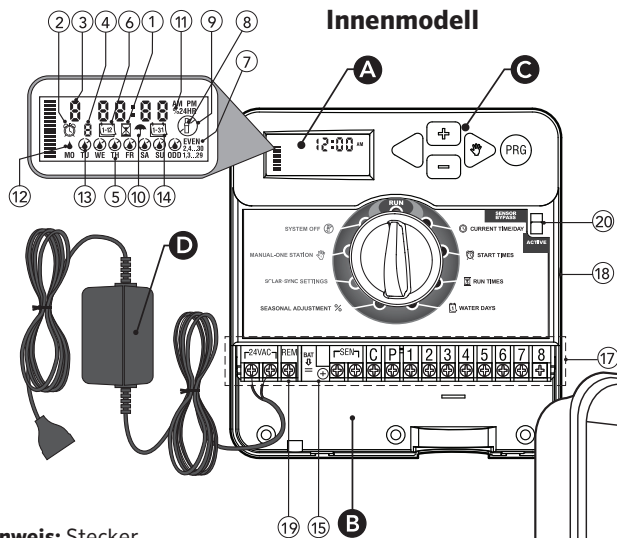

Hinweis: Stecker kann anders aussehen, als hier abgebildet.



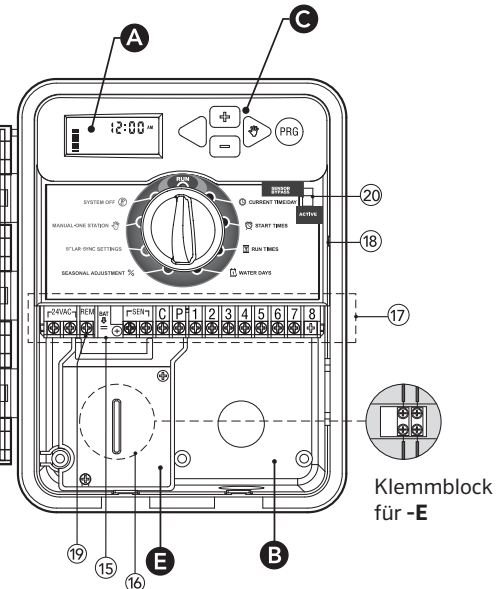



Außenmodell (einschließlich eingebautem Transformator)



X-CORE BESTANDTEILE

B Anschlussfach		
15	Lithiumbatterie	Mit der austauschbaren Lithiumbatterie (wird mitgeliefert) kann die Steuerung auch ohne Netzversorgung programmiert werden. Durch die Batterie verliert die Steuerung auch bei einem Stromausfall nicht das eingegebene Programm
16	Innerer Verteilerkasten	Verteilerkasten bei Außenmodellen für Anschluss an Netzstrom
17	Anschlussleiste	Hier werden Trafo, Ventile und Sensor an die Steuerung angeschlossen
18	Reset Taste	Hier kann die Steuerung neu initialisiert werden
19	REM	Ermöglicht die Verbindung mit Hunter SmartPort® und Hunter-Fernbedienungen
20	Sensor Bypass Schalter	Ignoriert die Eingabe vom "Clik"-Regensensor, wenn der Überbrückungsmodus aktiviert ist
C Bedienungstasten		
	+ Taste	Erhöht den blinkenden Wert im Display
	- Taste	Reduziert den blinkenden Wert im Display
	◀ Taste	Führt zur vorherigen Eingabe zurück
	▶ Taste	Führt weiter zur nächsten Eingabe
	Ⓜ Taste	Wählt Programm A, B oder C für verschiedene Bewässerungsbereiche

X-CORE BESTANDTEILE

Drehknopf		
	Betrieb	Normalstellung für den Automatik- und Handbetrieb
	 Einstellung Tag/ Stunde	Eingeben des aktuellen Tages und Stunde
	 Einstellung Zyklusstarts	Mit dieser Funktion können Sie 1 bis 4 Startzeiten in jedem Programm einstellen
	 Einstellung Beregnungsdauer	Mit dieser Funktion können Sie die Laufzeit jeder Ventilsektion von 1 Minute bis 4 Stunden einstellen
	 Einstellung Beregnungstage	Eingabe eines Intervalls, an dem die Bewässerung stattfinden soll
	% Saisonale Anpassung	Ermöglicht die jahreszeitliche Anpassung der Beregnungsdauer, ohne dass eine Neuprogrammierung des Steuergerätes erforderlich ist. Die Balken auf der linken Seite ermöglichen eine schnelle visuelle Überprüfung des Prozentsatzes der saisonalen Anpassung
	 Manueller Betrieb - Eine Sektion	Aktiviert eine einmalige, zusätzliche Bewässerung einer Sektion
	 Aus	Automatikbetrieb wird unterbrochen. Dient auch zum Einstellen der programmierbaren „Regenunterbrechung“, mit der die Beregnung für einen Zeitraum von 1 bis 7 Tagen unterbrochen wird
	SOLAR SYNC® Einstellungen	Ermöglicht dem Benutzer die Programmierung von Einstellungen, wenn der Solar Sync ET Sensor verwendet wird
D Externer Transformator (nur Innenmodell)		
		Ein Netztrafo versorgt das Steuergerät mit Netzstrom

WANDMONTAGE DES STEUERGERÄTES



HINWEIS: Das X-Core Innenmodell ist nicht spritzwasser- oder wetterfest und muss daher an geschützter Stelle im Innenbereich montiert werden.

1. Schrauben Sie eine Schraube (A) in die Wand. Verwenden Sie bei Leichtbauwänden oder massivem Mauerwerk einen Dübel.
2. Schieben Sie die Schlüssellochöffnung (B) and der Gehäuseoberseite über die Schraube.
3. Fixieren Sie nun das EC Steuergerät mit weiteren Schrauben in den vorgesehenen Löchern (C) unterhalb der Anschlussklemmen.



HINWEIS: Den Trafo erst an der Steckdose anstecken, nachdem das Steuergerät montiert und alle Leitungen angeschlossen wurden.



HINWEIS: Für XC - x01 - A: Wenn das Netzkabel beschädigt ist, muss es vom Hersteller, von der Kundendienstvertretung oder von gleichwertig qualifiziertem Fachpersonal ausgewechselt werden, um Risiken auszuschließen.



HINWEIS: Für eine maximale Wasserbeständigkeit muss die Tür bei Stationen für den Außenbereich geschlossen bleiben.

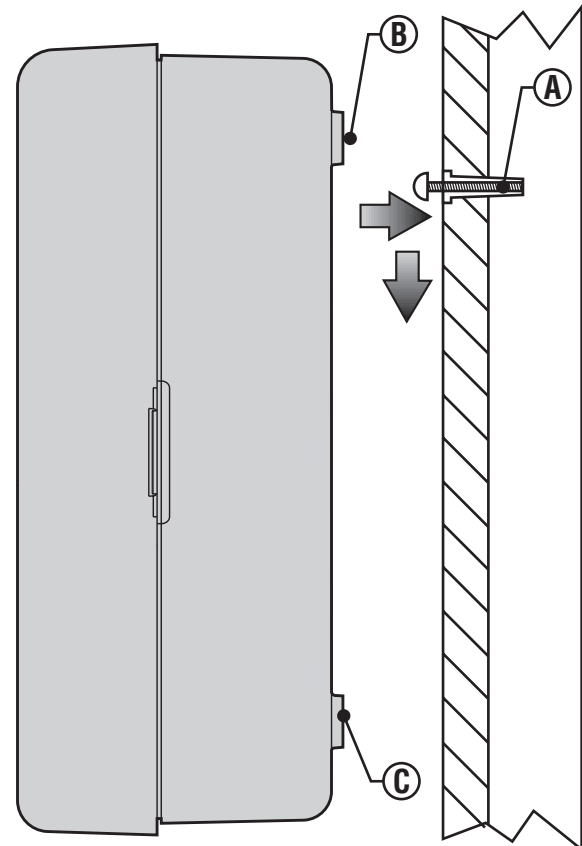

ANSCHLUSS VON VENTILEN UND TRAFU

1. Verlegen Sie die notwendigen Ventilkabel zwischen den Regelventilen und dem Steuergerät.
2. Bei den Ventilen verbinden Sie den gemeinsamen Nullleiter mit je einem Kabel jedes Ventils. Meistens wird dafür eine weiße Leitung gewählt. Das andere Kabel jedes Ventils wird mit je einer separaten Leitung verbunden. Für sämtliche Kabelanschlüsse sollten wasserdichte Verbindungen benutzt werden.
3. Führen Sie die Kabel durch den Kabelkanal. Befestigen Sie den Kabelkanal an der rechten unteren Seite des Steuergeräts.
4. Fixieren Sie nun die weiße Leitung an den C-Anschluss an der Anschlussleiste. Fixieren Sie die einzelnen Ventilkabel an den entsprechenden Sektionsnummern und ziehen Sie die Schrauben an.
5. Innenmodell: Führen Sie das Trafokabel durch die Öffnung an der linken Seite der Steuerung und fixieren es an den beiden Klemmen, die mit 24VAC gekennzeichnet sind.

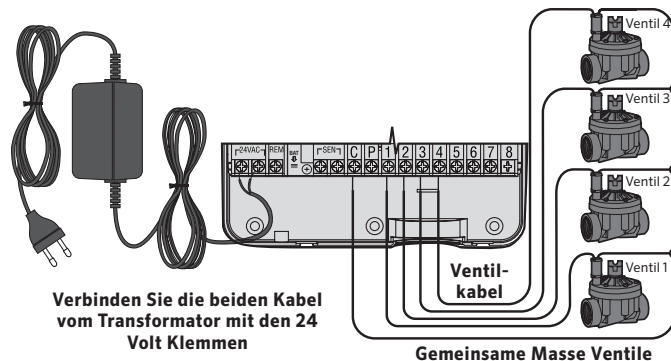

HINWEIS: Das Trafokabel für den Innenbereich darf nicht abgeschnitten werden. Wird das Kabel doch abgeschnitten, müssen die roten und weißen Drähte im Kabel miteinander verbunden werden, damit das Steuergerät funktioniert.

Außenmodell: Die Trafokabel sind bereits an den AC Anschlussklemmen installiert, so dass nur die Netzversorgung am Verteilerkasten hergestellt werden muss



HINWEIS: Das X-Core-Außenmodell ist spritzwasser- und wetterfest. Der Netzanschluss sollte nur von einem befugten Fachmann unter Berücksichtigung der nationalen Spezifikationen vorgenommen werden. Bei unsachgemäßem Anschluss besteht die Gefahr eines elektrischen Schlages oder Feuer.

ⓘ Hochspannungsverkabelung (nur bei Modellen für den Außenbereich)

1. Das Netzkabel wird durch die linke 13 mm (½") große Öffnung in der linken Geräteunterkante geführt.
2. Anschließend wird ein Kabel mit jedem der zwei Kabel im Anschlusskasten verbunden. Schließen Sie keine Hochspannung an die AC-Anschlussklemme im Inneren des Gerätes. Kabelstecker für den Anschluss sind im Lieferumfang enthalten. **Hinweis:** Bei E-Modellen werden die Kabel mit dem Wechselstromklemmblock im Inneren des Anschlusskastens verbunden.
3. Ersetzen Sie die Abdeckung des Anschlusskastens.

AKTIVIEREN DER BATTERIE

Stellen Sie sicher, dass Sie, nachdem Sie den X-Core installiert haben, den Isolator der Batterie entfernen, damit der X-Core bei Stromausfall nicht die Zeit verliert.



VORSICHT:
Explosionsgefahr Wenn Die Batterie Durch Einen Inkorrekten Batterietyp Ersetzt Wird. Entsorgen Sie Die Altbatterien Entsprechend Der Anleitung.

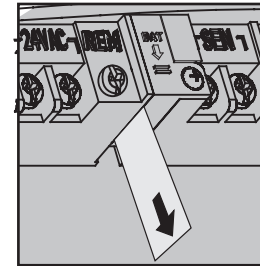

AUSTAUSCH DER BATTERIE

Das X-Core-Steuergerät enthält eine Hochleistungs-Lithiumbatterie. Durch die Batterie behält die Steuerung das eingeegebene Programm und ermöglicht auch eine Programmierung ohne Netzversorgung.

Durch die Batterie gehen auch bei einem Stromausfall nicht das eingeegebene Datum und die eingeegebene Zeit verloren. Zum Austauschen der Batterie:

1. Entfernen Sie die Schraube von der Batteriehalterung.
2. Schieben Sie die Batteriehalterung nach unten, um an die Batterie zu gelangen.
3. Entfernen Sie die Batterie und setzen Sie die neue Batterie in die Batteriehalterung. Bauen Sie die Batteriehalterung wieder ein.

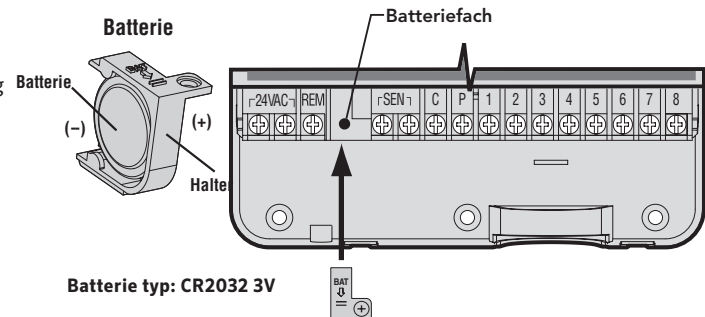

Batterie typ: CR2032 3V



HINWEIS: Das positive (+) Ende der Batterie muss zur Innenseite der Batterie zeigen.

ANSCHLUSS EINES HAUPTVENTILS



HINWEIS: Befolgen Sie diesen Abschnitt nur, wenn Sie auch wirklich ein Hauptventil an ihrem Bewässerungssystem installiert haben. Ein Hauptventil ist ein „stromlos geschlossenes“ Ventil, welches in der Zuleitung montiert ist und nur offen ist, wenn ein Bewässerungszyklus erfolgt.

1. Bei dem Hauptventil verbinden Sie den gemeinsamen Nullleiter mit je einem Kabel des Ventils.
Das andere Kabel des Ventils wird mit je einer separaten Leitung verbunden.
2. Schließen Sie einen Pol an die **C**-Klemme im Inneren des Steuergerätes. Schließen Sie den anderen Pol vom Hauptventil an die **P**-Klemme im Inneren des Steuergerätes. Ziehen Sie die Schrauben an.

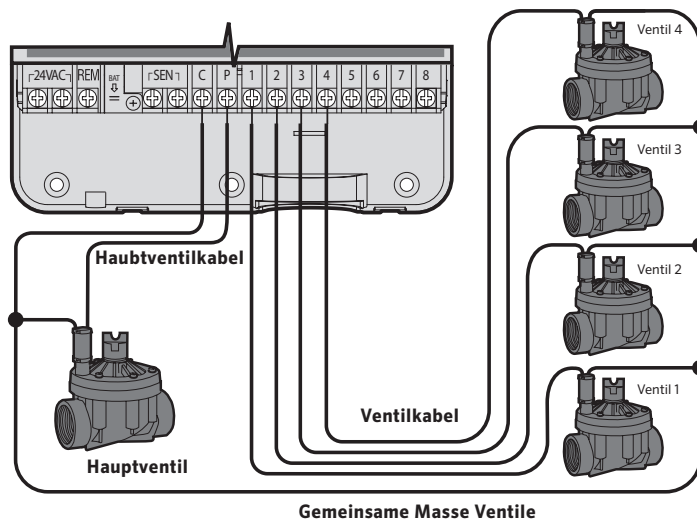

ANSCHLUSS EINES PUMPENSTARTRELAIS



HINWEIS: Dieses Kapitel ist für Sie nur von Interesse, wenn Sie auch ein Pumpenstartrelais haben. Dieses Relais verwendet ein Signal des Steuergeräts um einen eigenen Stromkreis zu schalten, z.B. um eine Pumpe in Betrieb zu nehmen, die Ihre Bewässerungsanlage mit Wasser versorgt.

Das Steuergerät sollte mindestens 4,5 m vom Pumpenstartrelais und der Pumpe entfernt montiert werden, um eventuelle elektrische Störungen auf ein Minimum zu beschränken.

1. Führen Sie ein Kabelpaar vom Pumpenstartrelais zum Steuergerät.
2. Schließen Sie einen Pol an die **C**-(Masse - in der Regel ein weißes Kabel) Klemme im Inneren des Steuergerätes, den anderen vom Pumpenstartrelais an die **P**-Klemme.

Die Haltespannung des Relais darf 0.30 Ampere nicht überschreiten. Niemals eine Pumpe direkt am Steuergerät anschließen, da sonst das Steuergerät beschädigt werden könnte.

<http://www.hunterindustries.com/support/controllers/pump-start-relay>

PSR Pumpenstart Relais

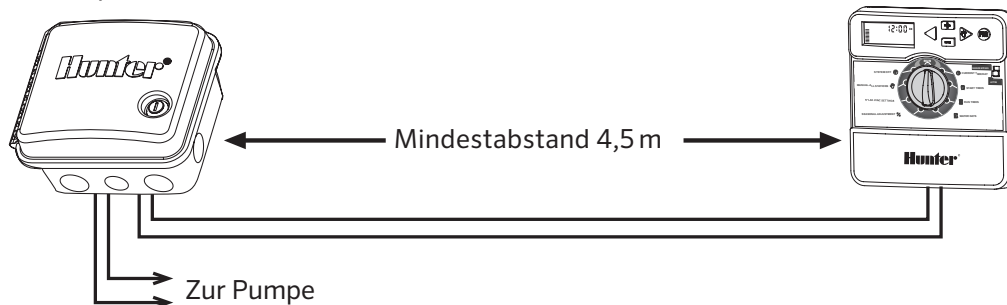

ANSCHLUSS EINES REGENSENSORS

Ein Hunter Mini-Clik® Regensensor oder jeder andere potentialfreie Regensensor kann direkt an der X-Core Steuerung angeschlossen werden. Der Zweck dieses Sensors ist die automatische Bewässerung zu stoppen bzw. zu verhindern, wenn natürlicher Niederschlag fällt.

1. **Entfernen Sie die Brücke** an den beiden SEN Anschlussklemmen der Steuerung.
2. Verbinden Sie die Anschlussdrähte mit den beiden SEN Anschlussklemmen.

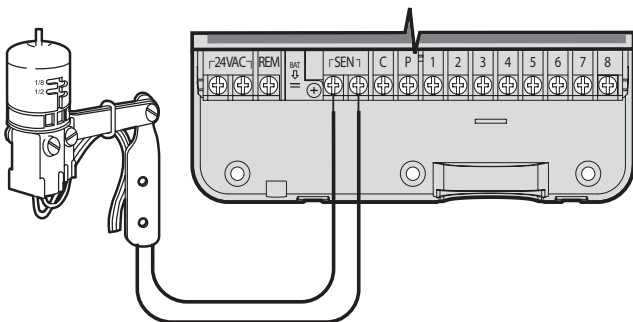

Wenn der Sensor die automatische Bewässerung abgeschaltet hat, erscheinen die Symbole OFF, und  auf dem Display.



Testen des Regensensors

Das X-Core erleichtert den Funktionstest eines angeschlossenen Regensensors. Sie können die Funktionsfähigkeit des Regensensors manuell überprüfen, indem Sie einen **AUTOZYKLUS** durchführen oder das System über den **One-Touch AUTOZYKLUS** aktivieren (siehe Seite 22). Wenn Sie während des manuellen Durchlaufs die obere Spindel am Mini-Clik® drücken, wird die Beregnung unterbrochen.

Manuelle Umgehung des Regensensors

Wenn der Sensor die automatische Bewässerung verhindert, können Sie den Sensor mit dem Umgehungs-Schalter an der Vorderseite der Steuerung umgehen. Stellen Sie den Schalter auf **SENSOR UMGEHUNG**, um den Regensensor abzuschalten und so den Betrieb der Steuerung zu ermöglichen. Außerdem können Sie den Regensensor für den manuellen Betrieb mit **MANUELLER BETRIEB-EINE STATION** umgehen.



Bei der Funktion **MANUELLER BETRIEB - EINE STATION** umgeht das Steuergerät automatisch die Sensoreingänge für den ausgewählten Zeitraum. Ist dieser Vorgang abgeschlossen, wird das Steuergerät wieder die ausgewählten Einstellungen übernehmen.



HINWEIS: Eine Aktivierung des Sensor-Überbrückungs-schalters hat keine Auswirkungen auf die Updates zur Saisonanpassung vom Solar Sync Sensor. Dennoch wird so die Rain-Clik und Freeze-Clik Funktion des Sensors umgangen.

SOLAR SYNC-EINSTELLUNGEN

Das X-Core-Steuergerät ist kompatibel mit Solar Sync und Wireless Solar Sync-Systemen. Solar Sync ist ein Sensorsystem, das die Bewässerungslaufzeiten des X-Core-Steuergeräts mithilfe der saisonalen Anpassung automatisch an Änderungen der lokalen Wetterbedingungen anpasst. Der Solar Sync verwendet einen Sonnenlicht- und Temperatursensor, um die Evapotranspiration (ET), d.h. die Rate, mit der Pflanzen und Rasen Wasser verbrauchen, zu bestimmen. Das Gerät beinhaltet außerdem Hunter Rain Klik- und Freeze Klik-Technologie, sodass die Bewässerung bei Regen und/oder Frost ausgeschaltet wird.



HINWEIS: Solar Sync wendet einen Standardwert von 100 % für die saisonale Anpassung an, bis erstmals Wetterdaten für einen vollständigen Tag (24 Stunden) vom Sensor empfangen wurden.



HINWEIS: Die Aktivierung des Überbrückungsschalters für den Sensor hat keine Auswirkungen auf die Aktualisierung der saisonalen Anpassung durch den Solar Sync-Sensor. Die Rain Klik- und Freeze Klik-Funktionalität des Sensors wird jedoch unterbunden.



HINWEIS: Das Solar Sync Modul ist nicht für die Installation über das X-Core Steuergerät erforderlich.

Installieren des Solar Sync-Sensors

Schließen Sie die grüne und die schwarze Ader vom Solar Sync-Sensor an die mit „SEN“ gekennzeichneten Anschlüsse des X-Core-Steuergeräts an. Welche Ader mit welchem Anschluss verbunden wird, ist nicht wichtig. Stellen Sie den Drehschalter auf die Position „Solar Sync-Einstellungen“. Auf der Anzeige sind zunächst gestrichelte Linien zu sehen und dann die Standardeinstellungen für die Region (3) auf der linken Seite und für die Wasseranpassung (5) auf der rechten Seite.



Installieren des Wireless Solar Sync

Schließen Sie die grüne und die schwarze Ader vom Wireless Solar Sync-Empfänger an die mit „SEN“ gekennzeichneten Anschlüsse des X-Core-Steuergeräts an. Welche Ader mit welchem Anschluss verbunden wird, ist nicht wichtig. Stellen Sie den Drehschalter auf die Position „Solar Sync-Einstellungen“. Auf der Anzeige sind zunächst gestrichelte Linien zu sehen und dann die Standardeinstellungen für die Region (3) auf der linken Seite und für die Wasseranpassung (5) auf der rechten Seite.



Solar Sync-Einstellungen

Nachdem ein Solar Sync-Sensor an das X-Core-Steuergerät angeschlossen wurde, werden auf dem Display zwei Zahlen angezeigt und die Solar Sync-Einstellungen können programmiert werden. Die Zahl links ist die Einstellung für die Region und die Zahl rechts ist die Einstellung für die Wasseranpassung.

PROGRAMMIEREN DES SOLAR-SYNC-MODULS

Region

Um genaue Solar Sync-Messungen zu erhalten, muss das Steuergerät für die durchschnittliche Hochsaison-ET für Ihre Region programmiert werden. Bestimmen Sie Ihre Region mithilfe der folgenden Tabelle.

Anhand der Tabelle können Sie den Regionstyp bestimmen, in dem Sie leben. Es gibt grundsätzlich vier ET-Regionen, die jeweils genau beschrieben und für die die typischen ET- und Temperatur-eigenschaften angegeben sind. Es wird empfohlen, die Region am besten anhand der durchschnittlichen ET im Juli oder der ET im Hochsommer (mm pro Tag) zu wählen.

Wählen Sie Ihre Region anhand der folgenden Tabelle aus (Referenzwerte unten). Die Erläuterungen unter **A**, **B** oder **C** helfen Ihnen, den richtigen Regionstyp auszuwählen:

- A)** Auf Basis der ET Ihrer Region unter Verwendung der durchschnittlichen ET im Juli oder der ET im Hochsommer (mm pro Tag). Bei der Auswahl Ihrer Region ist dies die bevorzugte Option.
- B)** Auf Basis der Temperatur für Ihre Region unter Verwendung der durchschnittlichen Temperatur im Juli oder im trockensten Monat (nicht der höchsten Temperatur im Juli).
- C)** Auf Basis der allgemeinen Beschreibung Ihrer Region.





WÄHLEN SIE FÜR IHRE EINSTELLUNGEN DEN REGIONSTYP, DER IHRE REGION AM BESTEN BESCHREIBT.

	A	B	C
Region 1	Bei einer durchschnittlichen ET im Juli / im Hochsommer von < 4,3 mm (0.17") pro Tag	Bei einer durchschnittlichen Temperatur im Juli / im Hochsommer von 18°C–24°C (65°–75°)	<ul style="list-style-type: none"> • U.S. nördliche Staaten • Nord- und mitteleuropäische Länder • Küstenregionen
Region 2	Bei einer durchschnittlichen ET im Juli / im Hochsommer von 4,6mm–5,8mm (0.18"–0.23") pro Tag	Bei einer durchschnittlichen Temperatur im Juli / im Hochsommer von 24°C–29°C (75°–85°)	<ul style="list-style-type: none"> • Mittel- und südeuropäische Länder • Berge • U.S. nördliches Inland
Region 3	Bei einer durchschnittlichen ET im Juli / im Hochsommer von 6.1 mm–7.4 mm (0.24"–0.29") pro Tag	Bei einer durchschnittlichen Temperatur im Juli / im Hochsommer von 29°C–35°C (85°–95°)	<ul style="list-style-type: none"> • Südeuropa / Mittelmeerraum • U.S. südliche Staaten
Region 4	Bei einer durchschnittlichen ET im Juli / im Hochsommer von > 7.6 mm (0.30") pro Tag	Bei einer durchschnittlichen Temperatur im Juli / im Hochsommer von 35°C–41°C (95°–105°)	<ul style="list-style-type: none"> • Wüstenregionen

* Für Regionen der südlichen Hemisphäre ist der Monat Januar zu verwenden.

PROGRAMMIEREN DES SOLAR-SYNC-MODULS

Bewässerungseinstellung



Wenn Sie den Eindruck haben, dass die von Ihnen bewässerte Fläche „feuchter“ oder „trockener“ ist, als sie sein sollte, können Sie die Bewässerung mit der Funktion zur Bewässerungsanpassung für alle Stationen nachregulieren. Drücken Sie auf den Knopf , bis der Pfeil über dem Symbol  angezeigt wird. Mit dem Knopf  oder  können Sie die Wassermenge im Bereich von 1 bis 10 erhöhen oder verringern (1 für weniger Wasser und 10 für mehr Wasser). Hunter empfiehlt, innerhalb der ersten Betriebswochen die Leistung zunächst genau zu beobachten, bevor Sie Anpassungen an der Bewässerung vornehmen.



Hinweis: Wenn eine bestimmte Zone „feuchter“ oder „trockener“ ist als der Rest des Systems, verlängern oder verkürzen Sie einfach die Laufzeit dieser Station am Steuergerät.

Ausbau eines Solar Sync-Sensors

Wenn ein Solar Sync-Sensor am X-Core-Steuergerät installiert wurde, wird der vom Steuergerät verwendete Wert für die saisonale Anpassung anhand der Daten berechnet, die der Solar Sync-Sensor liefert. Wenn der Solar Sync-Sensor nicht länger mit dem X-Core-Steuergerät verwendet werden soll, muss er ausgebaut werden. **Wird der Solar Sync-Sensor nicht ausgebaut, kann der Wert für die saisonale Anpassung am Steuergerät nicht manuell geändert werden.** Wenn der Wert für die saisonale Anpassung beim Entfernen des Solar Sync-Sensors am Steuergerät zum Beispiel als 50 % angezeigt wird, bleibt dieser Wert bei 50 %, bis der Solar Sync-Sensor ausgebaut wird

Um den Solar Sync-Sensor auszubauen, trennen Sie einfach die grüne und die schwarze Ader vom Anschluss des Steuergeräts und stellen den Drehschalter auf die Position „Solar Sync-Einstellungen“. Die jetzt auf dem Display erscheinenden Striche zeigen an, dass das Steuergerät den Solar Sync-Sensor nicht mehr für die Berechnung der saisonalen Anpassung erkennt. Sie können den Wert für die saisonale Anpassung jetzt manuell ändern, indem Sie den Drehschalter auf die Position „Saisonale Anpassung“ stellen und den Wert mit den  oder  Tasten einstellen.

PROGRAMMIEREN DES SOLAR-SYNC-MODULS

Kalibrier-/Einrichtungszeitraum

Nach der Installation und Programmierung von Solar Sync sollte das System zunächst einige Tage mit den Anfangseinstellungen betrieben werden. Wegen der verschiedenen Standortbedingungen (z. B. Sensorstandort, direkte Sonneneinstrahlung am Sensor, Wärmereflexion der Umgebung usw.) **müssen die Anfangseinstellungen ggf. noch angepasst werden, um die gewünschte Bewässerungsleistung zu erzielen.** Das Solar Sync System kann für einen bestimmten Standort einfach durch Anpassung der Regions- und/oder Bewässerungseinstellungen kalibriert werden. In den folgenden Anweisungen wird dieser Vorgang beschrieben:

1. Installieren Sie den Solar Sync Sensor, und programmieren Sie das Modul
2. Lassen Sie das System mindestens drei Tage lang mit den Anfangseinstellungen arbeiten.
3. Beobachten Sie die saisonale Anpassung am Steuergerät. Wenn der Wert für die saisonale Anpassung kleiner oder größer ist, als für die Jahreszeit erwartet wird, muss das Solar Sync System nachjustiert werden.
 - a. **Saisonale Anpassung zu klein:** Erhöhen Sie den Wert auf der Skala der Bewässerungseinstellung (Voreinstellung ist 5). Nach dem Ändern der Einstellung wird das Steuergerät sofort auf den neuen Prozentsatz der saisonalen Anpassung aktualisiert. Erhöhen Sie die Bewässerungseinstellung, bis die gewünschte saisonale Anpassung in Prozent angezeigt wird. **Wenn Sie auf der Skala für die Bewässerungseinstellung bereits beim Maximum von 10 angelangt sind und eine noch größere saisonale Anpassung erforderlich ist, stellen Sie die nächst niedrigere Region ein (z. B. von 4 auf 3).**
 - b. **Saisonale Anpassung zu groß:** Senken Sie den Wert auf der Skala der Bewässerungseinstellung (Voreinstellung ist 5). Nach dem Ändern der Einstellung wird das Steuergerät sofort auf den neuen Prozentsatz der saisonalen Anpassung aktualisiert. Verringern Sie die Bewässerungseinstellung, bis die gewünschte saisonale Anpassung in Prozent angezeigt wird. **Wenn Sie auf der Skala für die Bewässerungseinstellung bereits beim Minimum von 1 angelangt sind und eine noch kleinere saisonale Anpassung erforderlich ist, stellen Sie die nächst höhere Region ein (z. B. von 2 auf 3).**

Stationslaufzeiten: Es ist wichtig zu wissen, dass Solar Sync die saisonale Anpassung am Steuergerät global regelt. Dies bedeutet, dass alle Stationslaufzeiten um den angezeigten Prozentsatz der saisonalen Anpassung geändert werden. Beim Programmieren des Steuergeräts sollten Sie die Laufzeiten eingeben, die den Bewässerungszeitplänen zu Spitzenzeiten entsprechen. Wenn Solar Sync den entsprechenden Wert der saisonalen Anpassung einstellt und die Laufzeit für eine bestimmte Station zu lang oder zu kurz ist, muss die Laufzeit im Programm des Steuergeräts entsprechend angepasst werden.

SOLAR SYNC VERZÖGERUNGSFUNKTION

Solar Sync Verzögerung für das X-CORE®

Die Verzögerungsfunktion ist erst nach der Installation des Solar Sync verfügbar. Die Solar Sync Verzögerungsfunktion ermöglicht es dem Benutzer, Änderungen an der saisonalen Anpassung durch Solar Sync um bis zu 99 Tage zu verschieben.

Auch während die Solar Sync Verzögerung aktiviert ist, wird Solar Sync weiterhin Werte sammeln und speichern.

Betrieb:

So greifen Sie auf die Einstellungen der Solar Sync Verzögerung zu:

1. Drehen Sie den Drehschalter zuerst auf die Position **BETRIEB**; halten Sie die Taste **+** gedrückt, stellen Sie den Drehschalter auf Solar Sync und lassen Sie anschließend die Taste **+** wieder los. Es wird der folgende Bildschirm angezeigt: **d:XX** (d steht hier für Tage und **XX** für die Anzahl an zu verzögernden Tagen).
2. Drücken Sie die Tasten **+** oder **-**, um die Anzahl der Tage zu reduzieren/zu erhöhen, die die Verzögerung andauern soll. Sobald die gewünschte Anzahl an Tagen angezeigt wird, drehen Sie den Drehschalter erneut auf die Position **BETRIEB**, um die Verzögerung zu aktivieren.

So ändern Sie die bisherige Verzögerungseinstellung:

1. Öffnen Sie das Menü „Solar Sync Verzögerung“. Halten Sie die Taste **+** gedrückt, drehen Sie den Schalter auf „Solar Sync Einstellungen“ und lassen Sie anschließend die Taste **+** wieder los.
2. Mit den Tasten **+** oder **-** können Sie jetzt die zu verzögernden Tage ändern. (Indem Sie die Anzahl an Tagen auf **00** stellen, schaltet die Solar Sync Verzögerung auf **AUS**.)
3. Stellen Sie den Drehschalter zurück auf die Position **BETRIEB**, damit die Änderungen wirksam werden.

Auch während die Solar Sync Verzögerung aktiviert ist, wird Solar Sync weiterhin Wetterdaten sammeln und die Werte für die saisonale Anpassung berechnen. Die aktualisierte saisonale Anpassung tritt in Kraft, sobald die Tage für die Solar Sync Verzögerung **00** erreichen.



HINWEIS: Die verbleibende Anzahl an Tagen wird nicht auf dem Bildschirm **BETRIEB** angezeigt. Um zu überprüfen, ob die Verzögerungsfunktion aktiviert ist, öffnen Sie einfach das Menü Solar Sync Verzögerung und sehen Sie sich die dort angezeigten Tage an. Wenn 1 oder mehr Tage angezeigt werden, ist die Solar Sync Verzögerung aktiv, wenn **00** angezeigt werden, ist die Solar Sync Verzögerung nicht aktiv.

PROGRAMMIEREN DES SOLAR-SYNC-MODULS

Verbindung mit einer Hunter-Fernbedienung (nicht im Lieferumfang enthalten)

Das X-Core-Steuergerät ist mit Hunter-Fernbedienungen (nicht im Lieferumfang enthalten) kompatibel. Der SmartPort®-Kabelsatz (im Lieferumfang aller Hunter-Fernbedienungen enthalten) ermöglicht eine schnelle und einfache Verwendung mit Hunter-Steuergeräten. Mit einer Hunter-Fernbedienung können Sie das System bedienen, ohne zum Steuergerät zurück gehen zu müssen.

So installieren Sie den Anschluss des SmartPort®

1. Installieren Sie ein T-Stück mit ½" Innengewinde am Kabelkanal (nicht im Lieferumfang enthalten) ca. 12 Zoll unterhalb des X-Core.
2. Führen Sie die roten, weissen und blauen Leitungen des Kabelbaums durch die Basis des T-Stücks, und in den Kabelkasten, wie in Abbildung 1 dargestellt.

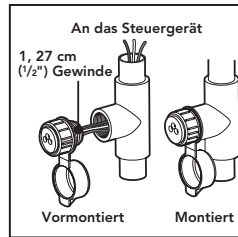

3. Schrauben Sie das SmartPort-Gehäuse wie abgebildet in das T-Stück.
4. Verbinden Sie die rote, die weiße und die blaue SmartPort-Ader mit dem Anschluss des Steuergeräts wie unten abgebildet:
 - Rote Ader an den Anschluss „24VAC“ auf der linken Seite
 - Weiße Ader an den Anschluss „24VAC“ auf der rechten Seite
 - Blaue Ader an den Anschluss „REM“

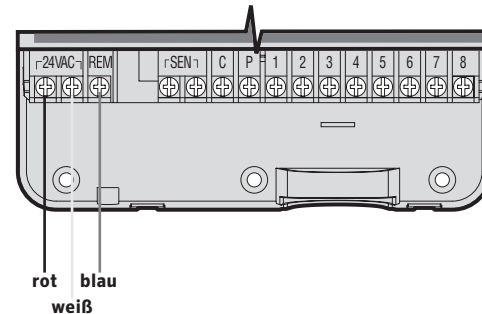



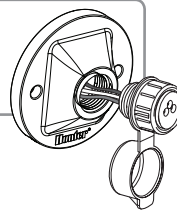

HINWEIS: PN 258200 kann als alternative Methode für die Montage des SmartPort-Anschlusses verwendet werden.



STROMAUSFALL



















Wegen der Gefahr eines Stromausfalls verfügt die Steuerung über einen permanenten Speicher. Bei Stromausfall gehen daher keine programmierten Informationen verloren. Durch die Lithiumbatterie bleibt die korrekte Zeit auch ohne Netzanschluss erhalten. Die normale Beregnung wird wieder aufgenommen, wenn die Stromversorgung wieder hergestellt ist.

PROGRAMMIERUNG DES STEUERGERÄTS

Das X-Core Display zeigt Uhrzeit und Tag, wenn sich das Steuergerät im Automatikmodus befindet. Wenn Sie den Drehknopf verstellen, um Programmierungen vorzunehmen, ändert sich auch die Anzeige. Beim Programmieren ändern Sie den blinkenden Teil der Anzeige mit den  oder  Tasten. Zum Ändern eines nicht blinkenden Feldes, drücken Sie die  oder  Tasten, bis das entsprechende Feld blinkt.

Drei Programme A, B und C, jedes mit vier möglichen Starzeiten pro Tag, ermöglichen eine Trennung von Pflanzen mit unterschiedlichen Wasseranforderungen.

Einstellen von Datum und Uhrzeit

1. Stellen Sie den Drehknopf auf die Position **EINSTELLUNG TAG/STUNDE**.
2. Die Jahresanzeige blinkt. Mit den  oder  Tasten können Sie das Jahr verändern. Nachdem Sie das Jahr programmiert haben, drücken Sie die  Taste, um zur Monatsanzeige zu gelangen.
3. Monat und Tag erscheinen auf dem Display. Der Monat blinkt und das  Symbol erscheint. Mit den  oder  Tasten können Sie den Monat verändern. Drücken Sie die  Taste, um zur Tagesanzeige zu gelangen.
4. Der Tag blinkt und das  Symbol erscheint. Mit den  oder  Tasten können Sie den Tag verändern. Drücken Sie die  Taste, um zur Zeitanzeige zu gelangen.
5. Die Zeitanzeige erscheint. Drücken Sie die  oder  Taste, um zur Zeitdarstellung (AM/PM oder 24h) zu gelangen. Drücken Sie die  Taste, um zur Stundenanzeige zu gelangen. Die Stundenanzeige blinkt. Drücken Sie die  oder  Tasten, um die Stundenanzeige auf dem Display zu verändern. Drücken Sie die  Taste, um zur Minutenanzeige zu gelangen. Die Minutenanzeige blinkt. Drücken Sie die  oder  Tasten, um die Minutenanzeige auf dem Display zu verändern. Uhrzeit und Tag sind nun fertig eingestellt.



HINWEIS: Eine Grundregel beim Programmieren ist, dass das blinkende Symbol bzw. Zeichen verändert werden kann: z.B., falls die Stundenanzeige blinkt, können Sie diese verändern. Blinkende Zeichen sind in dieser Anleitung GRAU dargestellt.

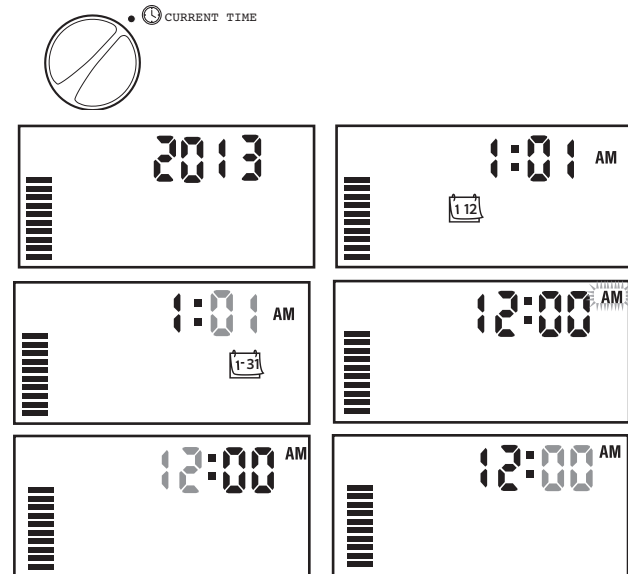

PROGRAMMIERUNG DES STEUERGERÄTS

Einstellen einer programmierten Startzeit

1. Stellen Sie den Drehknopf auf **EINSTELLUNG ZYKLUSSTARTS**.
2. Das Gerät ist automatisch auf Programm A voreingestellt. Drücken Sie die **PRO** Taste, bis das gewünschte Programm im Display erscheint.
3. Mit den **+** oder **-** Tasten können Sie die Startzeit (in 15-Minuten Schritten) verändern.
4. Drücken Sie die **▶** Taste, um eine neue Startzeit hinzuzufügen, oder drücken Sie die **PRO** Taste für das nächste Programm.

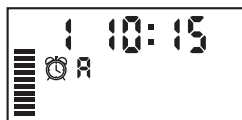

HINWEIS: Eine Startzeit aktiviert alle Sektionen. So muss nicht jeweils die Startzeit einer jeden Sektion eingegeben werden. Mehrere Startzeiten ermöglichen mehrere Bewässerungsdurchgänge pro Tag: z.B. in der Früh, am Nachmittag und am Abend. Die Startzeiten können in beliebiger Reihenfolge eingegeben werden. Der X-Core sortiert sie automatisch.

Löschen einer programmierten Startzeit

Wenn sich der Drehknopf auf **EINSTELLUNG ZYKLUSSTARTS** befindet, drücken Sie die **+** oder **-** Tasten, bis Sie 12:00 am bzw. 24:00 erreichen. Jetzt drücken Sie einmal die **▶** Taste und erreichen damit die **OFF** Position. Drücken Sie auf den rechten Pfeil, um eine zweite Startzeit zu vermeiden.

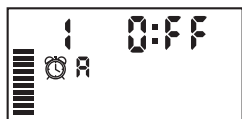



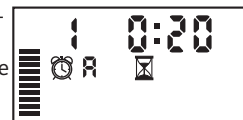

Einstellen der Beregnungsdauer

1. Drehen Sie den Drehknopf auf **Einstellung Beregnungsdauer**.
2. Am Display erscheint das zuletzt gewählte Programm (A, B oder C), die Sektionsnummer, das  Symbol und die blinkende Laufzeit. Mit der **PRO** Taste können Sie das Programm wechseln.
3. Mit den **+** or **-** Tasten können Sie die Beregnungsdauer einstellen. Die Laufzeiten können Sie zwischen 0 Minuten und 4 Stunden einstellen.
4. Drücken Sie die **▶** Taste, um zur nächsten Sektion zu gelangen.







Einstellen der Beregnungstage

1. Drehen Sie den Drehknopf auf **EINSTELLUNG BEREGNUNGSTAGE**.
2. Am Display erscheint das zuletzt gewählte Programm (A, B oder C). Mit der **PRO** Taste können Sie das Programm wechseln.
3. Zusätzlich sehen Sie die Tage 1 bis 7 MO, TU, WE, TH, FR, SA, SU (MO = Montag, TU = Dienstag, WE = Mittwoch, TH = Donnerstag, FR = Freitag, SA = Samstag, SU = Sonntag) mit einem  Symbol oder einem  Symbol über dem Tag. Das  Symbol zeigt an, dass an diesem Tag bewässert wird. Bei einem  Symbol findet an diesem Tag im gewählten Programm keine Bewässerung statt.



PROGRAMMIERUNG DES STEUERGERÄTS





Auswählen von einzelnen Tagen der Woche

- Mit dem  Cursor auf einem Tag (der Cursor startet immer bei MO), drücken Sie die  Taste um diesen Tag zu aktivieren. Drücken Sie die  Taste um für diesen Tag die Bewässerung auszuschalten. Nach dem Drücken einer dieser beiden Tasten springt der Cursor automatisch zum nächsten Tag.
- Wiederholen Sie Schritt 1 bis Sie die Einstellungen für alle Wochentage eingegeben haben. Die Tage, an denen bewässert werden soll, sind nun alle mit  markiert. Als letztes  erscheint der letzte Tag, an dem das Programm bewässert.



Einstellen von ungeraden oder geraden Beregnungstagen

Bei dieser Funktion werden nummerierte Tage des Monats für die Bewässerung gewählt, anstatt spezifischer Wochentage (ungerade Tage: 1., 3., 5. etc.; gerade Tage: 2., 4., 6. etc.).



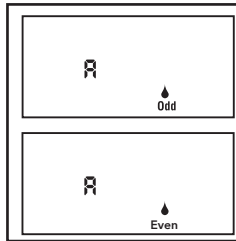

- Drücken Sie den  rechten Pfeil, bis sich der Cursor über SO befindet.
- Drücken Sie den rechten Pfeil erneut und „Ungerade Tage“ wird mit dem  angezeigt. Wenn „Ungerade Tage“ gewünscht sind, drehen Sie den Schalter wieder zurück auf die Position „Betrieb“.
- Wenn Sie an geraden Tagen bewässern möchten, drücken Sie die Taste  einmal. Das Symbol  und **GERADE** werden angezeigt. Sie können zwischen **UNGERADE** und **GERADE** mit den Tasten  umschalten.



HINWEIS: Wenn ungerade Tagen ausgewählt wurden, findet am 31. eines Monats und am 29. Februar keine Bewässerung statt.

Intervallbewässerung

Mit dieser Option können Sie ein Intervall von 1 bis 31 Tagen zwischen den Bewässerungstagen einstellen.

- Mit der Anzeige auf **EVEN**, drücken Sie die  Taste einmal, bis das  Symbol und eine blinkende 1 erscheinen. Auf dem Display erscheint der Kalender für die Intervallbewässerung.
- Drücken Sie die  oder  Taste, um die Anzahl der Tage zwischen den Bewässerungstagen auszuwählen (von 1 bis zu 31 Tagen). Diese Anzahl nennt man Intervall.

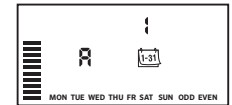



Das Steuergerät startet das gewählte Programm zur nächsten Startzeit und danach entsprechend dem gewählten Intervall.



Hinweis: Um den Intervallmodus zu beenden (falls nicht erwünscht), drücken Sie die linke Pfeiltaste, bis die Anzeige „Wochentag“ wieder eingeblendet wird.

Abschalten der Bewässerung an bestimmten Tagen

- Drehen Sie den Drehknopf auf **EINSTELLUNG BEREGNUNGSTAGE**.
- Geben Sie ein Intervall ein, so wie auf Seite 8 beschrieben.
- Drücken Sie die  Taste, um zu den Tagen, an denen nicht bewässert werden soll, am unteren Rand des Displays zu scrollen. Die Anzeige MO blinkt.
- Drücken Sie auf die  Taste, bis der Cursor auf dem Wochentag steht, für den Sie die Bewässerung abschalten wollen.

PROGRAMMIERUNG DES STEUERGERÄTS

- Drücken Sie die Taste, um für diesen Tag die Bewässerung auszuschalten. Das  Symbol leuchtet über diesem Tag auf.
- Wiederholen Sie die Schritte 4 und 5, bis die Bewässerung an allen gewünschten Tagen ausgeschaltet ist.



HINWEIS: Sie haben bei der Intervallbewässerung immer die Möglichkeit, eine Bewässerung an ungeraden oder geraden Tagen einzuprogrammieren.

Automatische Bewässerung

Nachdem Sie alle Programmierungen vorgenommen haben, stellen Sie den Drehknopf auf **BETRIEB**, um die automatische Ausführung aller ausgewählten Programme und Startzeiten zu aktivieren.



Systemunterbrechung

Alle gegenwärtig funktionierenden Magnetventile werden abgeschaltet, nachdem der Drehknopf für 2 Sekunden auf die **ANLAGE AUS** Position gedreht wird. Alle aktiven Programme werden unterbrochen und gestoppt. Um den Betrieb wieder zu aktivieren, drehen Sie einfach den Drehknopf wieder in die Automatikposition. Diese Funktion kann auch verwendet werden, um die Anlage generell auszuschalten z.B. in einer Schlechtwetterperiode. Das eingestellte Programm bleibt unverändert und wird durch drehen des Drehknopfes auf Betrieb wieder aktiviert.







Programmierbare Regenunterbrechung

Diese Funktion dient zur Unterbrechung der programmierten Bewässerung für einen Zeitraum von 1 bis 7 Tagen. Am Ende der

Unterbrechung wechselt das Steuergerät wieder in den normalen Automatikbetrieb.



- Drehknopf auf **AUS** stellen. Warten Sie, bis die Anzeige OFF erscheint.
- Mit den  oder  Tasten stellen Sie die Anzahl der Unterbrechungstage (1 bis 7) ein.
- Drehknopf wieder auf **BETRIEB** stellen. Es erscheinen OFF, eine Zahl sowie die  und  Symbole.





Jeweils um Mitternacht verringert sich die Anzeige der Unterbrechungstage um einen Tag. Wird 1 angezeigt, wechselt die Steuerung um Mitternacht wieder in den normalen Automatikbetrieb.



Saisonale Anpassung %

Diese Anpassung gestattet eine einfache, rasche Änderung der Beregnungsdauer aller Sektionen. Verwendung der „Saisonalen Anpassung“:

- Drehknopf auf **SAISONALE ANPASSUNG** drehen.
- Im Display sehen Sie eine blinkende Zahl mit %-Zeichen und einen Balken. Drücken Sie die  oder  Taste, um die Bewässerungsdauer prozentual zu verändern. Jeder Balken auf dem Diagramm steht für 10%. Mit dieser Funktion kann die Steuerung von 10% bis 150% des Originalprogramms angepasst werden.





PROGRAMMIERUNG DES STEUERGERÄTS

Um die sich neu ergebenden Laufzeiten zu sehen brauchen Sie nur den Drehknopf auf **EINSTELLUNG BEREGNUNGSDAUER** zu drehen. Die angezeigten Laufzeiten entsprechen jetzt dem gewählten %Satz.



HINWEIS: Neu- oder Umprogrammierungen sollten generell immer mit 100% durchgeführt werden.

Wenn Sie einen „Klik“-Wettersensor von Hunter verwenden, können Sie den Wert für die saisonale Anpassung wie oben beschrieben einstellen.

Wenn Sie den Solar Sync ET Sensor verwenden, wird der Wert für die saisonale Anpassung jeden Tag basierend auf dem vom Solar Sync-Sensor empfangenen Wettermuster automatisch aktualisiert. Sie können diesen Wert manuell außer Kraft setzen, indem Sie die  oder  Tasten drücken, bis der gewünschte Wert für die saisonale Anpassung erreicht ist. **Beachten Sie jedoch, dass der manuell geänderte Wert für die saisonale Anpassung um Mitternacht durch den neuen aktualisierten Wert vom Solar Sync-Sensor ersetzt wird.**

Der Solar Sync ET Sensor misst Wetterdaten, bestimmt den optimalen Wert für die saisonale Anpassung und aktualisiert das Steuergerät täglich.









Manueller Start einer einzelnen Sektion

1. Drehknopf auf **MANUELLER BETRIEB- EINE SEKTION** stellen.  
2. Die Laufzeit blinkt im Display. Verwenden Sie die  Taste, um zu der gewünschten Sektion zu gelangen. Mit der  oder  Taste wählen Sie die gewünschte Bewässerungsdauer.
3. Den Drehknopf nun im Uhrzeigersinn auf **BEREGNUNG** stellen um den Gießvorgang auszulösen (Nur die gewählte Sektion wird bewässert; die Steuerung kehrt anschließend in den Automatikmodus zurück; das eingestellte Programm wurde nicht verändert).

Siehe auch „**One Touch**“ - **Manueller Start und Weiterschaltung.**

„One Touch“ - Manueller Start und Weiterschaltung

Sie können einen kompletten Bewässerungsdurchgang starten, ohne den Drehknopf zu verwenden.





1. Halten Sie die  Taste für 2 Sekunden gedrückt.
2. Standardmäßig wird Programm A vorgeschlagen. Durch drücken der  Taste können Sie Programm B oder C wählen.
3. Die programmierte Laufzeit der 1. Sektion blinkt. Drücken Sie die  Taste um mit einer anderen Sektion zu beginnen und/oder verändern Sie die angezeigte Laufzeit mit den  oder  Tasten. (Wenn für 2 Sekunden keine Taste gedrückt wird beginnt die Bewässerung.)
4. Während des Bewässerungsdurchganges können Sie durch Drücken der  Taste zur nächsten Station springen. Wenn für 2 Sekunden keine Taste gedrückt wird, beginnt die Bewässerung. Sie können während des manuellen Durchgangs die  oder  Tasten benutzen, um manuell von einer Sektion zur nächsten zu wechseln.

FORTGESCHRITTENE FUNKTIONEN

Programmierbare Abschaltung des Sensors

Der X-Core ermöglicht die Unterbrechung sämtlicher programmierter Bewässerungsvorgänge an bestimmten Sektionen. So kann es z.B. vorkommen, dass Töpfe unter Überhängen oder Dächern bei Regen nicht genug Wasser erhalten und auch zu diesen Zeiten bewässert werden müssen.

Für die Programmierung der Abschaltung des Sensors:



1. Drehen Sie die Wählscheibe auf die Position **BETRIEB**.
2. Drücken Sie die  Taste und halten Sie sie während der Drehung des Drehknopfs in der Position **EINSTELLUNG ZYKLUS-STARTS** gedrückt.
3. Lassen Sie die Taste los. Zu diesem Zeitpunkt erscheint auf der Anzeige die Sektionsnummer, **ON** und ein blinkendes  Symbol.
4. Drücken Sie die  oder  Tasten, um den Sensor für die angezeigte Sektion abzuschalten.

ON = Sensor aktiviert (er wird die Bewässerung unterbrechen)

OFF = Sensor abgeschaltet (er lässt die Bewässerung zu)

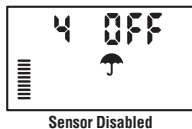
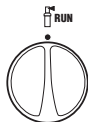
5. Scrollen Sie mit den Tasten  oder  zur nächsten Sektion, für die Sie den Sensor ausschalten wollen.





Wenn der X-Core vom Sensor eine Meldung zur Abschaltung der Bewässerung erhält, zeigt das Display die Sektionen an, für die eine Umgehung des Sensors programmiert wurde. Bei den Sektionen, für die eine Umgehung des Sensors programmiert wurde, blinken die  und  Symbole abwechselnd.

Überprüfen der Programme aller Sektionen





Bei dem X-Core kann der Benutzer auf einfache Weise ein Testprogramm durchlaufen.

Diese Funktion durchläuft jede Sektion in numerischer Abfolge, von der geringsten zur höchsten Zahl.

1. Stellen Sie den Drehschalter auf **BETRIEB** und halten Sie die Taste  gedrückt. So wird die Stationsnummer angezeigt und die Zeit blinkt für zwei Sekunden auf.
2. Mit den  oder  Tasten können Sie die Laufzeit von 1 bis 15 Minuten einstellen. Die Laufzeit muss nur einmal eingegeben werden.
3. Wenn für 2 Sekunden keine Taste gedrückt wird, beginnt das Testprogramm.

Hunter Quick Check Diagnose

Mit dieser Funktion können Sie mit dem Steuergerät schnell Probleme der Leitungen erkennen. Anstatt alle einzelnen Leitungskreisläufe auf eventuelle Probleme zu überprüfen, können Sie das Hunter Quick Check-Testprogramm nutzen. So starten Sie das Quick Check-Programm:

1. Drehen Sie die Wählscheibe auf die Position Betrieb.
2. Drücken sie gleichzeitig die Tasten , , , und . Im Stand-by-Modus erscheinen auf dem Display alle Bereiche.



HINWEIS: Das Steuergerät ist so vorprogrammiert, dass der Sensor die Bewässerung bei Regen in allen Bereichen abschaltet.

FORTGESCHRITTENE FUNKTIONEN

- Drücken Sie die **+**Taste einmal, um das Quick Check-Programm zu starten. Das System sucht innerhalb von Sekunden in allen Sektionen nach Problemen in den Kreisläufen. Wenn ein Kurzschluss entdeckt wurde, blinken das Symbol ERR und die Sektionsnummer auf dem Display. Wenn das Quick Check-Programm beendet wurde, kehrt das Steuergerät in den Automatik-Betrieb zurück.

Easy Retrieve™ Programmspeicher

Der X-Core kann ein bevorzugtes Bewässerungsprogramm speichern, damit es zu einem späteren Zeitpunkt wieder aufgerufen werden kann. Mit dieser Funktion kann das Steuergerät schnell auf einen zuvor programmierten Bewässerungskalender eingestellt werden.

So speichern Sie das Programm:

- Drücken Sie mit dem Drehknopf in der Position **BETRIEB** die **+** und **PRO** Tasten und halten Sie sie 5 Sekunden lang gedrückt. Über das Display laufen von links nach rechts drei Segmente , dadurch wird angezeigt, dass das Programm gespeichert wurde.
- Lassen Sie die **+** und **PRO** Tasten los.

So können Sie ein zuvor abgespeichertes Programm aufrufen:

- Drücken Sie mit dem Drehknopf in der Position **BETRIEB** die Taste und halten Sie sie 5 Sekunden lang gedrückt. Über das Display laufen von rechts nach links drei Segmente , dadurch wird angezeigt, dass das Programm reaktiviert wurde.
- Lassen Sie die **+** und **PRO** Tasten los.

Programmierbare Verzögerungszeit zwischen den Sektionen

Dieses Bedienelement ermöglicht dem Benutzer die Addition einer Verzögerung zwischen dem Abschalten einer Station und dem Anspringen der nächsten Station.

- Beginnen Sie mit dem Drehknopf in der Position **BETRIEB**.
- Drücken Sie die **+** Taste und halten Sie sie während der Drehung des Drehknopfs in der Position **EINSTELLUNG BERECHNUNGSDAUER** gedrückt.
- Lassen Sie die Taste los. Zu diesem Zeitpunkt erscheint auf der Anzeige und für sämtliche Stationen eine aufblinkende Verzögerungszeit in Sekunden.
- Drücken Sie die Tasten **+** oder **-**, um die Verzögerungszeit zwischen 0 Sekunden und 4 Stunden zu verlängern oder zu verkürzen.
- Drehen Sie den Drehknopf auf die Position **BETRIEB** zurück.

Löschen des Speichers/ Reset des Steuergeräts

Bei Programmierfehlern ist es möglich, den Speicher des Steuergerätes auf eine einfache Art und Weise zu „säubern“, und somit die ab Werk vorgegebenen Werte wiederherzustellen.

- Halten Sie die **PRO** Taste gedrückt.
- Halten Sie die Taste **PRO** gedrückt und drücken Sie kurz die Taste rechts auf dem Steuergerät.
- Halten Sie die Taste **PRO** so lange gedrückt, bis die Uhrzeit 12:00 angezeigt wird (dies dauert ca. 8 Sekunden).

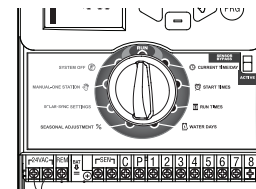

Zurücksetzen

CLIK VERZÖGERUNG ANWEISUNGEN

Klik-Verzögerungsfunktion

Mit dieser Funktion kann der Benutzer die programmierte Berechnung für einen bestimmten Zeitraum (von 1-7 Tagen) verzögern, nachdem ein Klik-Event endet. Nach Ende des programmierten Klik-Verzögerungszeitraums wird das Steuergerät den programmierten Berechnungszeitplan fortsetzen.

1. Stellen Sie den Drehschalter auf **BETRIEB**
2. Halten Sie die Taste „+“ 3 Sekunden lang gedrückt und drehen Sie den Schalter auf „AUS“
3. Lassen Sie die Taste „+“ los. Auf dem Display wird die programmierbare Klik-Verzögerung angezeigt.



4. Drücken Sie die Taste „+“, um die Dauer der Klik-Verzögerung (von 1 bis 7 Tagen) einzustellen.
5. Stellen Sie den Drehschalter wieder auf **BETRIEB**. Die Klik-Verzögerung ist eingestellt.

Nachdem ein Klik-Event endet (der Regensensor wechselt von nass zu trocken), wird die Klik-Verzögerungsfunktion aktiviert und auf dem Bildschirm die Dauer der Klik-Verzögerung angezeigt. Die Tage werden 24 Stunden nach dem Start der Klik-Verzögerung heruntergezählt.



Eine aktive Klik-Verzögerung kann beendet werden, indem Sie den Drehschalter auf **AUS** stellen und warten, bis **AUS** nicht mehr blinkt. Stellen Sie anschließend den Schalter wieder auf die Position **BETRIEB**.

Jede Station, die auf „Sensor überbrücken“ gestellt ist, sowie Beleuchtungsprogramme werden während einer Klik-Verzögerung weiter ausgeführt.



HINWEIS: Seien Sie vorsichtig, wenn Sie die programmierbare Klik-Verzögerungsfunktion mit **Hunter Wind-Klik, Freeze-Klik, Soil-Klik und Frostkomponenten von Solar Sync und Rain/Freeze Klik** verwenden, da die Klik-Verzögerung erst **NACH** einem Klik-Event von diesen Geräten aktiviert wird.

VERBORGENE FUNKTIONEN

Programm anpassen

Auf dem X-Core sind werksseitig drei unabhängige Programme (A, B, C) mit jeweils vier Startzeiten eingerichtet, um den Anforderungen verschiedener Pflanzentypen gerecht werden zu können. Das X-Core kann so eingerichtet werden, dass nur ein Programm und eine Startzeit angezeigt werden, damit die Programmierung noch einfacher wird.

1. Stellen Sie den Drehschalter auf die Position **BETRIEB** .
2. Halten Sie die Taste - gedrückt. Stellen Sie den Drehschalter auf **BEREGNUNGSTAGE** .
3. Lassen Sie die Taste - los.
4. Mit den Tasten + und - können Sie die Programmmodi ändern.

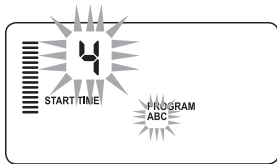

Normalbetrieb
(3 Programme/4 Startzeiten)

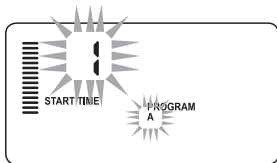

Eingeschränkter Betrieb
(1 Programm/1 Startzeit)

VERBORGENE FUNKTIONEN (FORTSETZUNG)

Zyklus- und Sickerphasen

Sie können die Laufzeiten der einzelnen Stationen in Zyklus- und Sickerphasen – d. h. in kürzere Berechnungsphasen – aufteilen. Diese Funktion ist besonders für die Berechnung von Gelände mit Gefälle oder verdichtetem Boden sinnvoll. Das Wasser wird automatisch langsamer zugeführt, hat mehr Zeit zum Versickern und läuft nicht ab. Wählen Sie als Zykluszeit einen Bruchteil der Berechnungsdauer einer Station. Als Sickerzeit wählen Sie die Pause in Minuten, die mindestens zwischen zwei Berechnungszyklen eingelegt werden soll. Um die Gesamtzahl der Zyklen zu ermitteln, teilen Sie die programmierte Gesamtlaufzeit der Station durch die Zykluszeit.

Zugriff auf das Menü Zyklus- und Sickerphasen:

Sie können auf die Funktion Zyklus- und Sickerphasen zugreifen, indem der Drehschalter auf die Position **BETRIEB** gestellt wird und Sie die Taste **+** 3 Sekunden lang gedrückt halten; während Sie **+** gedrückt halten, drehen Sie den Drehschalter auf die Position **LAUFZEIT** und lassen Sie anschließend die Taste los.

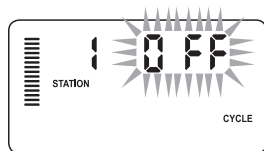

Beispiel für den Bildschirm Zyklusphasen bei der Eingabe

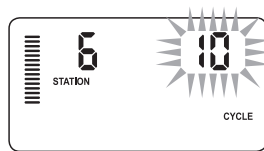

Beispiel für den Bildschirm Zyklusphasen mit angezeigten Minuten

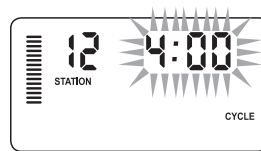

Beispiel für den Bildschirm Zyklusphasen mit angezeigten Stunden

Einstellen der Zykluszeiten:

Zuerst wird Station 1 angezeigt. Um auf weitere Stationen zuzugreifen, drücken Sie einfach die Tasten ◀ oder ▶.

Sobald die gewünschte Station angezeigt wird, können Sie mit den Tasten **+** oder **-** die Zykluszeit verringern oder erhöhen. Sie können die Sickerzeit von 1 Minute bis 4 Stunden in 1-Minutenschritten einstellen oder auf **AUS**, wenn kein Zyklus angewendet werden soll.



HINWEIS: Bei Zeiten unter 1 Stunde werden nur Minuten angezeigt (z.B. 36). Bei 1 Stunde oder mehr zeigt das Display zusätzlich die Stunden an (z.B. 1:13 und 4:00).

Wenn die Stationslaufzeit kürzer oder gleich der Zykluszeit ist, wird kein Zyklus angewendet.

VERBORGENE FUNKTIONEN (FORTSETZUNG)

Zugriff auf das Menü Sickerphasen:

Nachdem die gewünschten Zykluszeiten für jede Station programmiert wurden, können Sie auf diese zugreifen, indem Sie die Taste **PRG** drücken.

Die zuvor bei den Zykluszeiten angezeigte Station wird übernommen (d.h. wenn Station 2 im Menü Zyklus angezeigt wurde, dann wird auch Station 2 angezeigt, wenn Sie die Taste **PRG** drücken).



HINWEIS: Auf das Menü Sickerphasen kann nicht ohne eine programmierte Zykluszeit zugegriffen werden.

Einstellen der Sickerzeit:

Um auf weitere Stationen zuzugreifen, drücken Sie einfach die Tasten **◀** oder **▶**.



HINWEIS: Wenn Sie beim Stationswechsel auf eine Station ohne Zykluszeit stoßen, kehrt der Bildschirm automatisch zur Zykluszeit zurück. Wechseln Sie zur nächsten Station mit einer Zykluszeit und drücken Sie die Taste **PRG**, um zurückzukehren.

Sobald die gewünschte Station angezeigt wird, können Sie mit den Tasten **+** oder **-** die Sickerzeit verringern oder erhöhen. Sie können die Sickerzeit von 1 Minute bis 4 Stunden in 1-Minutenschritten einstellen.



HINWEIS: Bei Zeiten unter 1 Stunde werden nur Minuten angezeigt (z.B. 36). Bei 1 Stunde oder mehr zeigt das Display zusätzlich die Stunden an (z.B. 1:13 und 4:00).

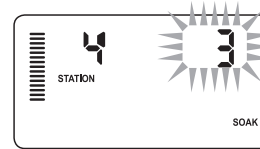

Beispiel für den Bildschirm Sickerphasen mit angezeigten Minuten

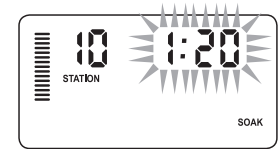

Beispiel für den Bildschirm Sickerphasen mit angezeigten Stunden

Zyklus- und Sickersituationen:

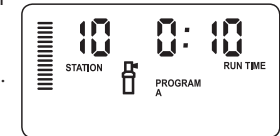

An Station 1 muss 20 Minuten lang bewässert werden. Bereits nach fünf Minuten beginnt das Wasser von der Oberfläche abzulaufen. Zum Versickern braucht das Wasser zehn Minuten. In diesem Beispiel würden Sie als Stationslaufzeit 20 Minuten, als Zykluszeit fünf Minuten und als Sickerzeit zehn Minuten programmieren.

Die Sickerzeit ist ein Mindestwert. Abhängig von den verbleibenden Laufzeiten kann die Sickerzeit auch länger andauern.





Zyklus der Station 10 in Betrieb

FEHLERSUCHE

Problem	Ursache	Lösung
Steuerung bewässert eine Sektion öfters als einmal	Zu viele Startzeiten in einem Programm eingegeben	Eine Startzeit genügt für einen kompletten Bewässerungsdurchgang (Siehe „Startzeiten“ auf Seite 18)
Display zeigt nichts an	Überprüfen, ob Netzversorgung vorhanden	Falls notwendig, korrigieren
Auf der Anzeige erscheint „No AC“	Das Gerät wird nicht mit Netzstrom versorgt	Überprüfen Sie, ob der Trafo sachgemäß installiert wurde
Auf dem Display erscheint „Off   “	Der Regensensor unterbricht die Bewässerung oder die Brücke wurde entfernt	Schieben Sie den Umgehungsschalter auf die Position BYPASS, um den Regensensor zu umgehen oder installieren Sie die Brücke erneut
Regensensor unterbricht nicht die Bewässerung	<ul style="list-style-type: none"> • Regensensor defekt • Brücke (Jumper) wurde nicht entfernt, als der Sensor installiert wurde • Die Sektionen wurden so programmiert, dass Sie den Sensor umgehen 	<ul style="list-style-type: none"> • Funktionstüchtigkeit des Sensors und korrekte Verkabelung überprüfen • Jumper entfernen • Programmieren Sie die Sensor-Umgehung erneut, um den Sensor zu aktivieren (siehe Seite 11)
Anzeige gefroren oder es erscheinen fehlerhafte Angaben auf dem Display	Stromquelle	Programmieren Sie das Steuergerät neu, wie auf Seite 24 unter „Löschen des Speichers / Reset des Steuergeräts“ beschrieben
In der Anzeige steht „ERR“ mit einer Nummer (1-8)	Fehler in der Verdrahtung oder defekte Magnetspule bei der angezeigten Sektion	<ul style="list-style-type: none"> • Verdrahtung auf Kurzschluss/Fehler überprüfen • Kurzschluss beheben bzw. Spule tauschen • Drücken Sie eine beliebige Taste, um die Anzeige zu löschen
Auf dem Display erscheint die Meldung „P ERR“	<ul style="list-style-type: none"> • Verkabelung des Hauptventils oder Pumpenrelais fehlerhaft • Pumpenrelais fehlerhaft oder nicht kompatibel • Verkabelung des Hauptventils oder Pumpenrelais nicht ausreichend 	<ul style="list-style-type: none"> • Überprüfen Sie die Kabel, die zum Relais oder dem Hauptmagnetventil führt • Drücken Sie auf eine beliebige Taste um „P ERR“ vom Display zu löschen • Überprüfen Sie die elektrischen Spezifikationen des Pumpenrelais • Überschreiten Sie nicht die elektrischen Daten des Steuergerätes • Ersetzen Sie dieses, falls es fehlerhaft ist • Ersetzen Sie den Draht mit einem Draht mit einer größeren Drahtstärke

FEHLERSUCHE

Problem	Ursache	Lösung
Display zeigt eine Bewässerung an, aber die Symbole  und  blinken	Der Sensor unterbricht die Bewässerung, obwohl eine Umgehung des Sensors programmiert wurde	Überprüfen Sie die Umgehung des Sensors (siehe Seite 23)
Ein Bewässerungszyklus startet nicht zur eingestellten Startzeit, und der Drehknopf steht nicht auf AUS	<ul style="list-style-type: none"> • AM/PM der Tageszeit sind nicht korrekt eingestellt • AM/PM der Startzeit sind nicht korrekt eingestellt • Startzeiten sind auf „Off“ gestellt • Die Stromversorgung ist unterbrochen • Es sind keine Bewässerungstage eingestellt 	<ul style="list-style-type: none"> • AM/PM der Tageszeit korrigieren • AM/PM der Startzeit korrigieren. • Siehe „Einstellen der Startzeiten“ (Seite 18) • Netzversorgung überprüfen • Bewässerungstage einstellen (Seite 14)
Das Display zeigt Striche an, wenn sich der Drehschalter auf der Position „Solar Sync-Einstellungen“ befindet	<ul style="list-style-type: none"> • Der Solar Sync-Sensor ist nicht an das Steuergerät angeschlossen • Die Kabel des Solar Sync-Sensors sind möglicherweise beschädigt oder nicht richtig angeschlossen 	Schließen Sie den Solar Sync-Sensor an die „SEN“-Anschlüsse des Steuergeräts an. Auf dem Display werden dann die Einstellungen für die Region und die Wasseranpassung angezeigt
Laufzeiten für eine bestimmte Sektion sind zu kurz/zuglang	Programmlaufzeit zu kurz/zuglang	Solar Sync bietet eine globale saisonale Anpassung für das Steuergerät. Wenn die Laufzeiten für eine bestimmte Sektion zu kurz oder zu lang sind, nehmen Sie beim Steuergerät eine entsprechende Korrektur des Programms vor. Stellen Sie die saisonale Anpassung auf 100% zurück, bevor Sie Änderungen an der Programmlaufzeit vornehmen. Stellen Sie dazu den Drehschalter auf die Position „Saisonale Anpassung“ und erhöhen oder verringern Sie den Wert auf 100%
Saisonale Anpassung scheint gering zu sein	<ul style="list-style-type: none"> • Region zu hoch • Wasseranpassung zu niedrig • Sensors befindet sich nicht vollständig in der Sonne 	<ul style="list-style-type: none"> • Erhöhen Sie den Wert für die Wasseranpassung (der Standardwert ist 5) • Wenn Sie selbst bei der maximalen Einstellung auf 10 mehr saisonale Anpassung benötigen, stellen Sie die Region um einen Wert nach unten (zum Beispiel von 4 auf 3) und beginnen Sie mit der Einstellung 5 für die Wasseranpassung. Solar Sync aktualisiert sofort die saisonale Anpassung am Steuergerät. Ist diese immer noch zu niedrig, wiederholen Sie die Anpassungen, bis auf dem Steuergerät die gewünschte saisonale Anpassung angezeigt wird

FEHLERSUCHE

Problem	Ursache	Lösung
Saisonale Anpassung scheint hoch zu sein	<ul style="list-style-type: none"> • Region zu niedrig • Wasseranpassung zu hoch 	Verringern Sie den Wert für die Wasseranpassung. Wenn Sie selbst bei der minimalen Einstellung auf 1 weniger saisonale Anpassung benötigen, stellen Sie die Region um einen Wert nach oben (zum Beispiel von 2 auf 3) und beginnen Sie mit der Einstellung 5 für die Wasseranpassung. Solar Sync aktualisiert sofort die saisonale Anpassung am Steuergerät. Ist diese immer noch zu hoch, wiederholen Sie die Anpassungen, bis auf dem Steuergerät die gewünschte saisonale Anpassung angezeigt wird
Solar Sync sendet immer noch Werte für die saisonale Anpassung, obwohl der Überbrückungsschalter des Steuergeräts auf „Bypass“ gestellt ist	Die automatische saisonale Anpassung von Solar Sync kann mit dem Überbrückungsschalter nicht deaktiviert werden. Der Überbrückungsschalter regelt lediglich die Abschaltung der Regen/Frost-Funktion des Solar Sync	
Nach dem Entfernen des Solar Sync-Sensors vom Steuergerät kann der Wert für die saisonale Anpassung nicht manuell geändert werden	Der Solar Sync-Sensor muss deinstalliert werden, wenn er dauerhaft vom Steuergerät entfernt werden soll	Nachdem Sie den Solar Sync-Sensor vom Steuergerät deinstalliert haben, stellen Sie den Drehschalter auf „Solar Sync-Einstellungen“. Auf dem Display werden gestrichelte Linien angezeigt. Der Sensor wurde deinstalliert
Anzeige meldet „no SS“	<ul style="list-style-type: none"> • Der Solar Sync-Sensor wurde vom Steuergerät getrennt, aber nicht deinstalliert • Die Verkabelung vom Solar Sync ist fehlerhaft 	<ul style="list-style-type: none"> • Überprüfen Sie die Kabelverbindung vom Solar Sync-Sensor zum Steuergerät • Deinstallieren Sie den Solar Sync-Sensor, wenn Sie ihn dauerhaft vom Steuergerät entfernen möchten (siehe Seite 14)

SPEZIFIKATIONEN

Ausstattungsmerkmale

- Laufzeit: 0 bis 4 Stunden in 1-Minuten Schritten
- Drei unabhängige Bewässerungsprogramme
- Startzeiten: 4 pro Tag, pro Programm (max. 12 tägliche Startzeiten)
- Bewässerungskalender: 365 Tage, Intervallprogramm, Bewässerung an geraden/ ungeraden Tagen
- AM/PM oder 24-Stunden Anzeige
- Einfacher Handbetrieb
- Umgehungsfunktion für Sensor
- Programmierbare Verzögerung (1 bis 7 Tage)
- Saisonale Anpassung (10% bis 150%)
- Drehknopf zur Umgehung des Sensors

Abmessungen

Innengerät

- Höhe: 16,5 cm
- Breite: 14,6 cm
- Tiefe: 5 cm

Aussengerät

- Höhe: 22 cm
- Breite: 17,8 cm
- Tiefe: 9,5 cm

Elektrische Spezifikationen

- Trafo Eingang: 230/240VAC, 50/60Hz (Internationale Modelle)
- Trafo Ausgang: 24VAC 1,0 A
- Ausgang pro Station: 0,56 A
- Maximaler Ausgang: 0,90 A (einschließlich Hauptventil)
- Batterie: 3V Lithium (mitgeliefert), zur Beibehaltung der Programmdateien und Programmierung bei Stromausfall C R2032 3-Volt
- Elektronischer Überspannungsschutz
- Permanenter Speicher für Programmdateien
- UL

Erläuterung der Symbole





~ = AC





 = Bedienungsanleitung lesen

 = Gefährliche Spannung







 = Erdung

ÍNDICE DE CONTENIDOS

COMPONENTES X-CORE	2
MONTAJE DEL PROGRAMADOR EN UNA PARED	3
CONEXIÓN DE VÁLVULAS Y TRANSFORMADOR	7
ACTIVACIÓN DE LA PILA	8
SUSTITUCIÓN DE LA PILA	8
CONEXIÓN DE UNA VÁLVULA MAESTRA	9
CONEXIÓN DE UN RELE DE ARRANQUE DE BOMBA	10
CONEXIÓN DE UN SENSOR METEOROLÓGICO “CLIK” DE HUNTER	11
Prueba del sensor meteorológico	11
Anulación manual del sensor meteorológico	11
CONEXIÓN DE UN SENSOR ET SOLAR SYNC DE HUNTER	12
Instalación del sensor Solar Sync	12
Instalación de Wireless Solar Sync® (Solar Sync inalámbrico)	12
Configuración de Solar Sync	12
Región 	13
Ajuste de riego 	14
Desinstalación de un sensor Solar Sync	14
Calibración/instalación	15
Función De Retraso Solar Sync	16
CONEXIÓN DE UN MANDO A DISTANCIA HUNTER	17
Conexión a un mando a distancia Hunter (no incluido)	17
Para instalar el conector SmartPort	17
FALLOS DE ALIMENTACIÓN	17
PROGRAMACIÓN DEL PROGRAMADOR	19
Configuración de la fecha y la hora 	19
Configuración de horas de inicio 	19
Eliminación de una hora de inicio	19
Configuración de los tiempos de riego 	19

Configuración de los días de riego 	19
Selección de días de la semana específicos de riego	20
Selección de días pares o impares de riego	20
Selección de riego por intervalos 	20
Configuración de días inactivos de eventos	20
Riego automático 	21
Sistema apagado 	21
Parada por lluvia programable	21
Ajuste estacional %	21
Riego manual de una estación 	22
Arranque y avance manual con una tecla	22
CARACTERÍSTICAS AVANZADAS	23
Anulación del sensor programable	23
Programa de prueba de todas las estaciones	23
Diagnóstico rápido de Hunter	23
Memoria de programas Easy Retrieve™	24
Retraso programable entre estaciones	24
Borrado de la memoria del programador/ Restablecimiento del programador	24
Instrucciones de Retraso Clik	25
Personalización de programas	26
Ciclo e infiltración	27
FUNCIONES AVANZADAS (CONTINUACIÓN)	27
GUÍA DE RESOLUCIÓN DE PROBLEMAS	28
ESPECIFICACIONES	31
Especificaciones de funcionamiento	31
Especificaciones eléctricas	31
Explicación de los símbolos	31
CERTIFICADO DE CONFORMIDAD CON LAS DIRECTRICES EUROPEAS	32

COMPONENTES X-CORE

A Pantalla LCD		
1	 Tiempos de riego	Permite al usuario establecer el tiempo de riego de cada válvula entre 1 minuto y 4 horas
2	 Horas de inicio	Permite configurar entre 1 y 4 horas de inicio en cada programa
3	Número de estación	Indica el número de estación seleccionado actualmente
4	Designador de programa	Identifica el programa que se está utilizando (A, B o C)
5	Día de la semana	Identifica el día de la semana
6	Intervalo de riego	Identifica el mes al programar la fecha actual
7	Riego en pares/impares	Indica si se ha seleccionado el riego en días pares/impares
8	Aspensor intermitente	Indica que el riego está en marcha
9	 Sistema apagado	Permite al usuario interrumpir todos los programas y el riego. También permite al usuario establecer la “parada por lluvia” programable que detiene el riego durante un período de entre 1 y 7 días.
10	 Paraguas	Indica que está activo el sensor de lluvia
11	% Ajuste estacional	Permite al usuario realizar cambios en los tiempos de riego en función de las estaciones sin reprogramar el programador. Las barras de la izquierda permiten contar con una referencia visual rápida del porcentaje de ajuste estacional. Al utilizar el sensor ET Solar Sync, se mostrará el ajuste estacional actualizado a diario por el sensor.
12	 Gota de lluvia	Indica que el riego tendrá lugar el día seleccionado
13	 Gota de lluvia tachada	Indica que el riego NO tendrá lugar el día seleccionado
14	 Calendario	Indica que se ha programado el programa de riego por intervalos. El icono también aparece al programar el día actual

COMPONENTES X-CORE

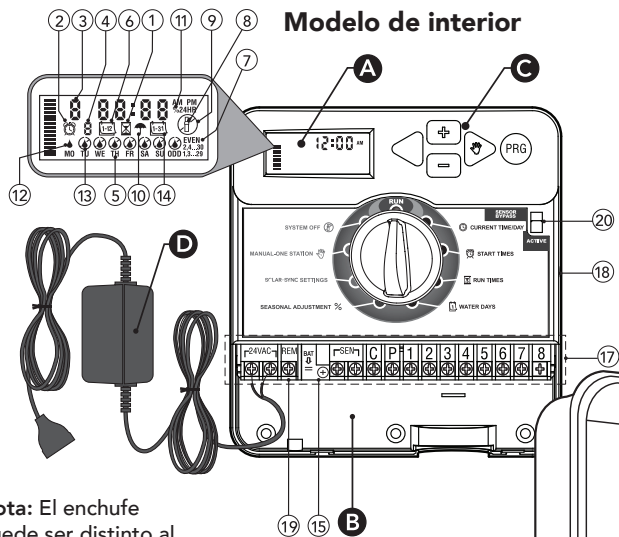

Nota: El enchufe puede ser distinto al de la ilustración



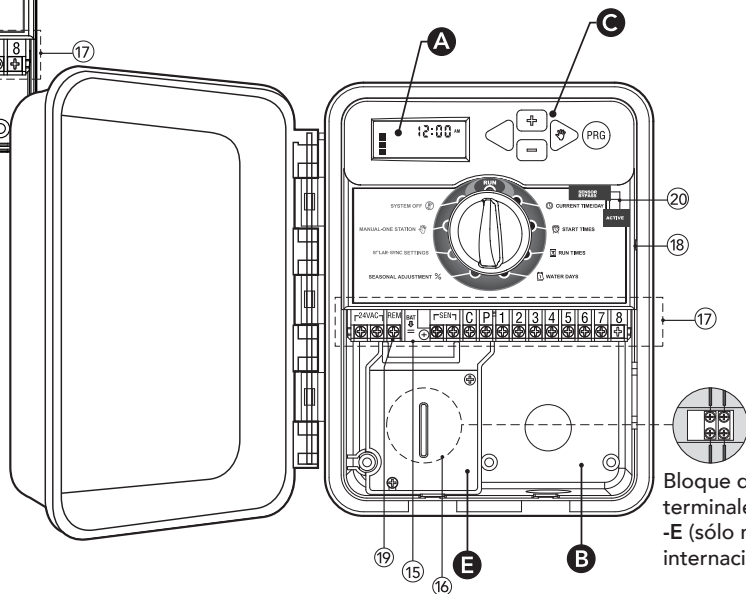



Modelo de exterior (Transformador interno incluido)



COMPONENTES X-CORE

B Compartimento del cableado		
15	Pila de litio	La pila de litio sustituible (incluida) permite programar el programador cuando no hay suministro de CA. Asimismo, la pila proporciona energía para mantener la hora en caso de interrupción del suministro eléctrico.
16	Caja de conexiones interna	Caja de conexiones en modelos de interior para establecer conexiones de alimentación de CA
17	Regleta de terminales	Utilícela para conectar los cables del transformador, el sensor y la válvula al programador
18	Botón Restablecer	Utilícelo para restablecer el programador (situado en el lateral del programador)
19	REM	Permite la conexión de SmartPort® de Hunter y de mandos a distancia de Hunter
20	Interruptor de bypass del sensor	No tiene en cuenta la entrada del sensor meteorológico “Clik” cuando está en la posición Bypass (anulación)
C Botones de control		
	+ Botón	Aumenta el elemento seleccionado que parpadea en la pantalla
	- Botón	Reduce el elemento seleccionado que parpadea en la pantalla
	◀ Botón	Hace que el cursor regrese al elemento anterior
	▶ Botón	Avanza el cursor al siguiente elemento
	ⓐ Botón	Selecciona el programa A, B o C para diferentes necesidades de zonas de riego

COMPONENTES X-CORE

Ajustes del dial		
	Riego	Posición normal del dial para funcionamiento automático y manual de todos controladores
	Hora/fecha actual	Permite configurar el día y la hora actuales
	Horas de inicio	Permite configurar entre 1 y 4 horas de inicio en cada programa
	Tiempos de riego	Permite al usuario establecer el tiempo de riego de cada válvula entre 1 minuto y 4 horas
	Días de riego	Permite al usuario seleccionar el intervalo de días de riego
	% Ajuste estacional	Permite al usuario realizar cambios en los tiempos de riego en función de las estaciones sin reprogramar el programador. Las barras de la izquierda permiten contar con una referencia visual rápida del porcentaje de ajuste estacional.
	Manual-Una estación	Permite al usuario activar un único riego de una sola válvula
	Sistema apagado	Permite al usuario interrumpir todos los programas y el riego. También permite al usuario establecer la “parada por lluvia” programable que detiene el riego durante un período de entre 1 y 7 días
	Ajustes SOLAR SYNC®	Permite al usuario programar los ajustes cuando se utiliza el sensor ET Solar Sync
D Transformador externo (sólo modelo de interior)		
		Se proporciona un conector en el transformador para el suministro de alimentación de CA al programador

MONTAJE DEL PROGRAMADOR EN UNA PARED



NOTA: la versión de interior de X-Core no es impermeable ni apta para instalación a la intemperie, por lo que debe instalarse en interiores o en áreas protegidas.

1. Fije un tornillo a la pared. Si la pared es de yeso o está cubierta de azulejos, utilice tacos para los tornillos.
2. Deslice el orificio en forma de llave situado en la parte superior del programador sobre el tornillo.
3. Fije el programador en su sitio mediante la instalación de tornillos en los orificios situados debajo de la regleta de terminales.



NOTA:No conecte el transformador a la toma eléctrica hasta que se haya montado el programador y se haya conectado todo el cableado de las válvulas.



NOTA: Para XC - x01 - A: Si el cable de alimentación está dañado, el fabricante, un agente de servicio o una persona igualmente capacitada deben sustituirlo para evitar riesgos.



NOTA: La puerta de las unidades para exterior debe permanecer cerrada para maximizar la resistencia al agua.

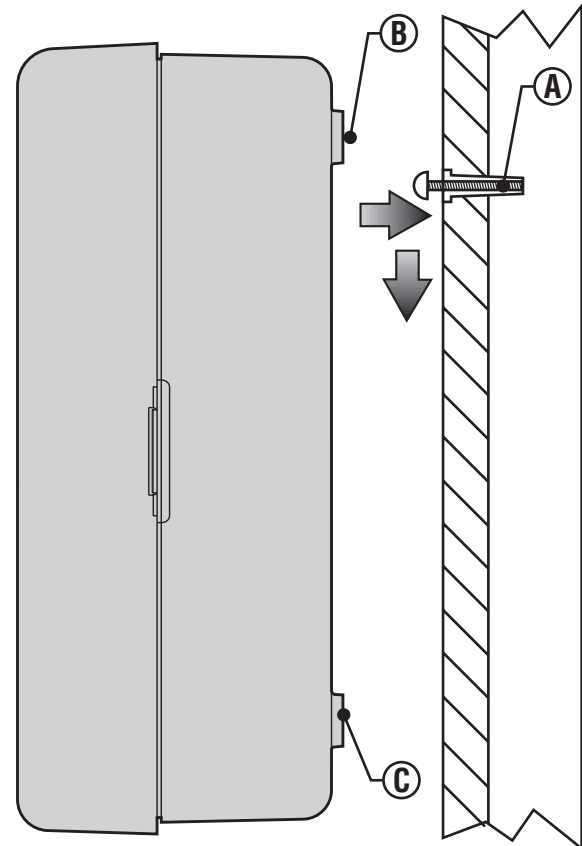

CONEXIÓN DE VÁLVULAS Y TRANSFORMADOR

La instalación de X-Core sólo debe realizarla personal cualificado.

1. Lleve los cables de las válvulas entre la válvula de control y el programador.
2. En las válvulas, conecte el cable común a cualquiera de los dos cables de solenoide de todas las válvulas. En la mayoría de los casos, se trata de un cable de color blanco. Conecte un cable de control independiente al otro cable de cada válvula. Todas las conexiones de los cables deben realizarse mediante conectores estancos.
3. Lleve los cables de las válvulas a través del conducto. Ajuste el conducto a través de la parte inferior derecha del programador.
4. Fije el cable común de las válvulas al tornillo C (Común) de la regla de terminales. Conecte cada uno de los cables de control de las válvulas a los correspondientes terminales de la estación y apriete los tornillos.
5. Modelos de interior: pase el cable del transformador a través del orificio que presenta el programador en su parte inferior izquierda y conecte los cables a los dos tornillos marcados con 24 VAC.

NOTA: El cable del transformador interior no debe cortarse. Si el cable se corta, los cables rojo y blanco en el cable se deben unir, o el controlador no funcionará.

Modelos de exterior: los cables del transformador ya están conectados a los terminales de CA, por lo que lo único que hay que hacer es conectar la alimentación principal a la caja de conexiones (véase más abajo).



NOTA: Los modelos de exterior X-Core son impermeables y aptos para instalación a la intemperie. La conexión del X-Core de exterior a la alimentación principal de CA sólo deberá realizarla un electricista cualificado conforme a la normativa local. La instalación incorrecta podría causar descargas eléctricas o riesgo de incendio.

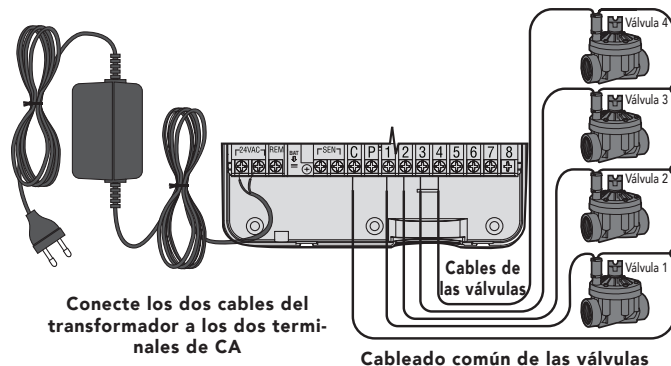

E Cableado de alta tensión (sólo modelo de exterior)

1. Pase el cable de alimentación de CA y el conducto a través de la apertura para conducto de 13 mm (½ pulgada) situado en la parte inferior izquierda del armario.
2. Conecte un cable a cada uno de los dos cables situados en el interior de la caja de conexiones. El cable de toma de tierra debe conectarse al cable verde. Se proporcionan tuercas para establecer estas conexiones.

Nota: sólo para modelos –E: conecte los cables al bloque de terminales de CA situado en el interior de la caja de conexiones. Los cables de suministro de CA deben ser de 1,5 mm² (calibre AWG 14) o mayores con disyuntor adecuado al tamaño del cable. La instalación del edificio deberá contar con un interruptor o disyuntor (en las proximidades del programador y fácilmente accesible por el operador) que esté señalizado como dispositivo de desconexión del equipo.

3. Vuelva a colocar la cubierta de la caja de conexiones.

ACTIVACIÓN DE LA PILA

Tras instalar el X-Core, asegúrese de que retira el aislante de contactos de la pila para permitir que el X-Core mantenga la hora en caso de interrupción del suministro eléctrico.

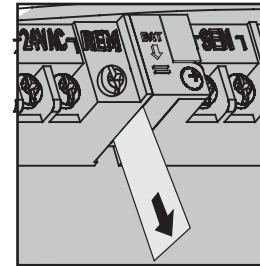

ADVERTENCIA:

Riesgo De Explosión Si La Pila Se Reemplaza Por Otra Del Modelo Incorrecto. Deseche Las Pilas Usadas De Acuerdo Con Las Instrucciones.

SUSTITUCIÓN DE LA PILA

El programador X-Core incluye una pila de litio de larga duración. La pila permite al usuario iniciar la programación de forma remota sin necesidad de corriente de CA. También se utiliza para mantener la hora y el día actuales cuando se producen interrupciones del suministro eléctrico. Para sustituir la pila:

1. Retire el tornillo del soporte de la pila.
2. Deslice el soporte de la pila hacia abajo para obtener acceso a la pila.
3. Retire la pila antigua y coloque la nueva en el soporte de la pila y vuelva a instalar el soporte de la pila.



NOTA: Este lado positivo (+) de la pila debe estar orientado hacia el interior del soporte de la pila.

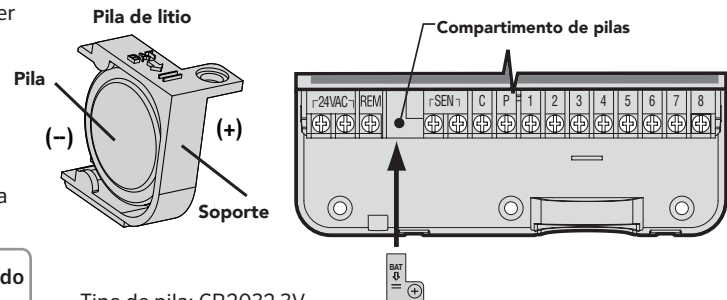

Tipo de pila: CR2032 3V

CONEXIÓN DE UNA VÁLVULA MAESTRA



NOTA: siga los pasos indicados en este apartado únicamente si tiene instalada una válvula maestra en su sistema de riego. Una válvula maestra es una válvula que normalmente está cerrada que se instala en el punto de suministro de la línea principal y que se abre únicamente cuando el programador inicia un programa de riego.

1. En la válvula maestra, conecte el cable común a cualquiera de los dos cables de solenoide de la válvula. Conecte un cable de control independiente al otro cable de solenoide.
2. El cable común debe conectarse al terminal **C** dentro del programador. El otro cable que procede de la válvula maestra debe conectarse al terminal **P** dentro del programador. Apriete el tornillo de cada uno de los terminales.

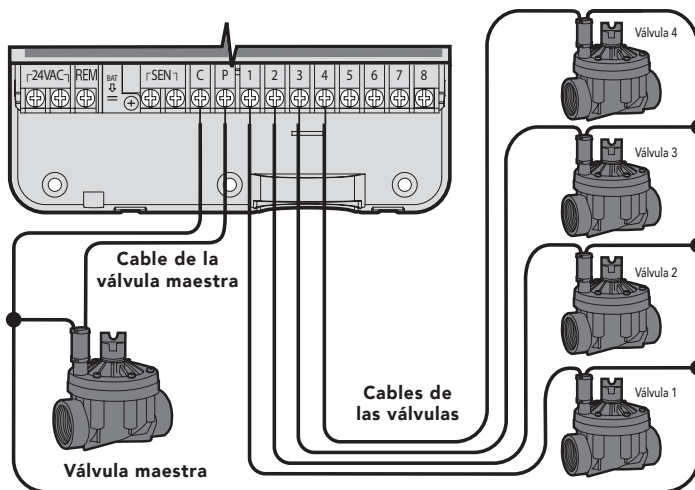

Cableado común de las válvulas

CONEXIÓN DE UN RELE DE ARRANQUE DE BOMBA



NOTA: siga los pasos indicados en este apartado únicamente si tiene un relé de arranque de bomba instalado. Un relé de arranque de bomba es un dispositivo que utiliza una señal del programador para activar un circuito eléctrico independiente que aplica energía a una bomba para suministrar agua al sistema.

El programador debe montarse al menos a 4,5 m (15 pies) de distancia tanto del relé de arranque de bomba como de la bomba para minimizar cualquier posible interferencia eléctrica.

1. Lleve un par de cables del relé de la bomba al programador.
2. Conecte un cable común al terminal **C** (común, típicamente un cable blanco) en el interior del programador y conecte el otro cable procedente del relé de arranque de bomba al terminal **P** (Pump: Bomba).

El consumo de corriente de mantenimiento del relé no debe exceder los 0,3 amperios. No conecte el programador directamente a la bomba, ya que provocaría daños en el programador.

<http://www.hunterindustries.com/support/controllers/pump-start-relay>

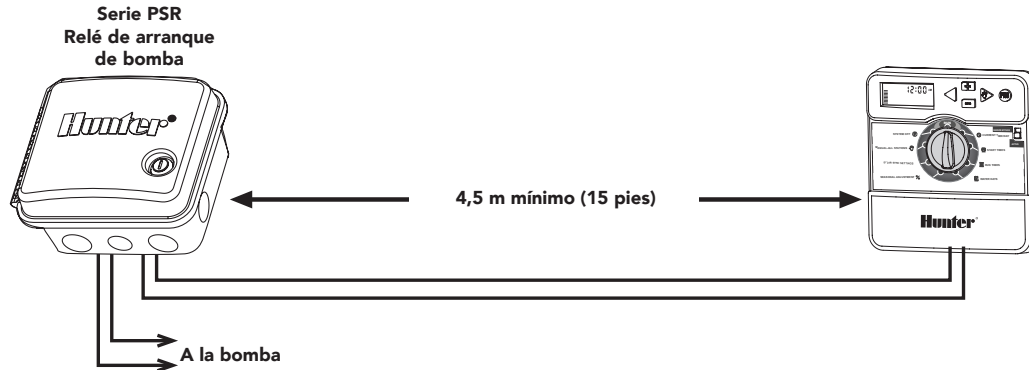

CONEXIÓN DE UN SENSOR METEOROLÓGICO “CLIK” DE HUNTER

Es posible conectar al X-Core un sensor meteorológico Hunter u otro sensor meteorológico de tipo microinterruptor. La finalidad de dicho sensor es detener el riego automático cuando las condiciones meteorológicas así lo exijan.

1. **Retire la placa puente de metal** de los dos terminales SEN situados en el interior del programador.
2. Conecte un cable a un terminal SEN y el otro cable al otro terminal SEN.

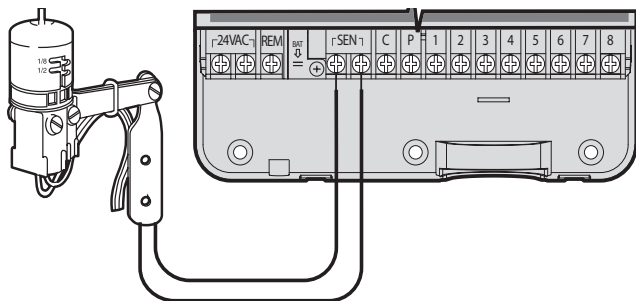

Cuando el sensor meteorológico haya desactivado el riego automático, aparecerán en la pantalla OFF (APAGADO) y el icono .



Prueba del sensor meteorológico

El X-Core permite realizar una prueba simplificada del sensor de lluvia cuando el sensor está conectado en el circuito de sensores. Puede probar manualmente el correcto funcionamiento del sensor de lluvia iniciando un **CICLO AUTOMÁTICO** o activando el sistema con el **CICLO AUTOMÁTICO con un solo botón**.

Si presiona la manivela superior del Mini-Clik® durante el ciclo manual, interrumpirá el riego.

Anulación manual del sensor meteorológico

Si el sensor de lluvia está interrumpiendo el riego, es posible anularlo mediante el mando de anulación situado en la parte delantera del programador. Coloque el interruptor en la posición **ANULAR** del sensor de lluvia para desactivarlo del sistema, de modo que pueda funcionar el programador. Al usar la función **MANUAL - UNA ESTACIÓN** el programador ignorará las entradas de los sensores de forma automática por el tiempo seleccionado. Tras finalizar, el programador regresará a la configuración seleccionada.



NOTA: Activar el interruptor de bypass del sensor no afecta a las actualizaciones de ajuste estacional realizadas por el sensor Solar Sync. Sin embargo, sí que omite la funcionalidad Rain Clik y Freeze Clik del sensor.

CONEXIÓN DE UN SENSOR ET SOLAR SYNC DE HUNTER

X-Core es compatible con los sistemas Solar Sync y Wireless Solar Sync (Solar Sync inalámbrico). Solar Sync es un sistema de sensor que ajusta automáticamente el programa de riego del programador X-Core (en función de los cambios de las condiciones climatológicas locales) empleando la función Seasonal Adjust (ajuste estacional). Solar Sync utiliza un sensor de radiación solar y de temperatura para determinar la evapotranspiración (ET) o índice de consumo de agua de las plantas y el césped. Asimismo, incluye tecnología Rain Klik y Freeze Klik de Hunter, que interrumpe el riego cuando llueve y/o cuando se producen heladas.



NOTA: Solar Sync aplica un valor de ajuste estacional predeterminado del 100% hasta que se reciben del sensor las mediciones meteorológicas correspondientes al primer día completo (período de 24 horas).



NOTA: La activación del interruptor de anulación de sensor no tiene ningún efecto sobre las actualizaciones del ajuste estacional procedentes del sensor Solar Sync. No obstante, omite la funcionalidad Rain Klik y Freeze Klik del sensor.



NOTA: No se requiere el módulo Solar Sync para la instalación usando el programador X-core.

Instalación del sensor Solar Sync

Conecte los cables verde y negro del Solar Sync a los terminales de conexión “SEN” del programador X-Core, similar a la imagen de la página 11. No importa a qué terminal se conecte cada cable. Gire el dial hasta la posición “Solar Sync Settings” (configuración de Solar Sync). La pantalla mostrará inicialmente líneas



de guiones y, posteriormente, el parámetro predeterminado de región (3) a la izquierda y el parámetro predeterminado de ajuste de riego (5) a la derecha. Ajuste la región según corresponda mediante los botones ▲ y ▼ (consulte la página 15 para ver una explicación de la configuración de región de Solar Sync). Utilice el botón ► para avanzar hacia la derecha para ajustar la configuración de Ajuste de riego según sea necesario (consulte la página 15 para ver una explicación de la configuración del Ajuste de riego).

Instalación de Wireless Solar Sync (Solar Sync inalámbrico)

Conecte los cables verde y negro del receptor Wireless Solar Sync (Solar Sync inalámbrico) a los terminales de conexión “SEN” del programador X-Core. No importa a qué terminal se conecte cada cable. Gire el dial hasta la posición “Solar Sync Settings” (configuración de Solar Sync). La pantalla mostrará inicialmente líneas de guiones y, posteriormente, el parámetro predeterminado de región (3) a la izquierda y el parámetro predeterminado de ajuste de riego (5) a la derecha. Ajuste la región según corresponda mediante los botones ▲ y ▼ (consulte la página 15 para ver una explicación de la configuración de región de Solar Sync). Utilice el botón ► para avanzar hacia la derecha para ajustar la configuración de Ajuste de riego según sea necesario (consulte la página 16 para ver una explicación de la configuración del Ajuste de riego).



Configuración de Solar Sync

Una vez que el sensor Solar Sync esté conectado al programador X-Core, aparecerán dos números en la pantalla cuando se gire el dial a la posición Solar Sync Settings (configuración de Solar Sync). El número de la parte izquierda de la pantalla es el parámetro de Región, mientras que el número de la derecha es el parámetro de Ajuste de riego (como se indica más arriba).

CONEXIÓN DE UN SENSOR ET SOLAR SYNC DE HUNTER

Región

Para que las mediciones de Solar Sync sean precisas, el programador debe programarse para la ET media en temporada alta de su región. Utilice la siguiente tabla para determinar su región.

Esta tabla le ayudará a identificar el tipo de región en la que vive. Existen cuatro regiones ET básicas; cada una incluye su descripción así como las características de ET y temperatura más habituales. Le recomendamos que, si es posible, seleccione la región adecuada a partir de la media de ET para julio o la ET máxima para verano (pulgadas o mm diarios).

Utilice la siguiente tabla para seleccionar su región (vea la referencia a continuación). Puede utilizar los métodos **A**, **B** o **C** como ayuda para elegir la región más adecuada para su zona:

A: Basada en la ET de su región utilizando la ET media de julio o la ET máxima para verano (pulgadas o mm diarios). Ésta es la opción preferente al elegir la región.

B: Según la temperatura de su región, utilizando la media de julio o de la temperatura más alta del mes más seco (no la temperatura más alta de julio).

C: Según la descripción general de su región.

SELECCIONE LA OPCION QUE MAS SE ADAPTE A SU ZONA.			
	A	B	C
Región 1	Si la ET media para julio es < 4,3 mm (0,17 pulg.) diarios	Si la temperatura media para julio es de 18°C - 24°C (65°F-75°F)	<ul style="list-style-type: none"> • EEUU - Estados del norte • Regiones costeras
Región 2	Si la ET media para julio es 4,6 mm - 5,8 mm (0,18 pulg. - 0,23 pulg.) diarios	Si la temperatura media para julio es de 24°C - 29°C (75°F-85°F)	<ul style="list-style-type: none"> • Montañas • EEUU - Estados interiores del norte
Región 3	Si la ET media para julio es 6,1 mm - 7,4 mm (0,24 pulg. - 0,29 pulg.) diarios	Si la temperatura media para julio es de 29°C - 35°C (85°F-95°F)	<ul style="list-style-type: none"> • EEUU - Estados del sur • Interior/Desierto Alto (California)
Región 4	Si la ET media para julio es > 7,6 mm (0,30 pulg.) diarios	Si la temperatura media para julio es de 35°C - 41°C (95°F-105°F)	<ul style="list-style-type: none"> • Desiertos

* Para lugares en el hemisferio sur, utilice el mes de enero.

CONEXIÓN DE UN SENSOR ET SOLAR SYNC DE HUNTER

Ajuste de riego \updownarrow

El ajuste de riego se establece en una escala del 1 al 10 que permite un ajuste sencillo del valor de ajuste estacional del sensor ET Solar Sync. Tras la instalación del sensor ET Solar Sync, se recomienda mantener el valor predeterminado de Ajuste de riego: 5. No obstante, tras la instalación, si observa que el valor de ajuste estacional es inferior o superior al esperado, podrá modificar el valor de Ajuste de riego para cambiar el valor resultante de Ajuste estacional. Consulte Calibración/instalación en la página 17 para ver una explicación de cómo utilizar la escala de Ajuste de riego con el fin de efectuar un ajuste preciso del valor resultante de ajuste estacional.



NOTA: Si una zona particular está “más húmeda” o “más seca” que el resto de su sistema, sólo tiene que incrementar o disminuir el tiempo de riego del programador.

Desinstalación de un sensor Solar Sync

Si se ha instalado un sensor Solar Sync en el programador X-Core, el valor de ajuste estacional utilizado por el programador se calculará a partir de los datos meteorológicos proporcionados por el sensor Solar Sync. Si se opta por no continuar utilizando el sensor Solar Sync con el programador X-Core, será necesario desinstalarlo. **Si no se desinstala el sensor Solar Sync, el programador no permitirá cambiar manualmente el valor de ajuste estacional.** Por ejemplo, si el valor de ajuste estacional mostrado en el programador era del 50% cuando se retiró el sensor Solar Sync, éste permanecerá al 50% hasta que se desinstale el sensor Solar Sync.

Para desinstalar el sensor Solar Sync, simplemente desconecte los cables verde y negro del terminal del programador y luego gire el dial a la posición “Solar Sync Settings” (configuración de Solar Sync). La pantalla debería mostrar guiones, lo que indica que el programador ya no reconoce el sensor Solar Sync para el cálculo del ajuste estacional. Ahora el valor de ajuste estacional se puede cambiar girando el mando hasta la posición “Seasonal Adjust” (ajuste estacional) y empleando el botón \oplus o \ominus para ajustar el valor.

CONEXIÓN DE UN SENSOR ET SOLAR SYNC DE HUNTER

Calibración/instalación

Después de instalar y programar Solar Sync, se recomienda dejar que el sistema funcione durante algunos días con la configuración inicial. Debido a la variedad de condiciones locales (incluidos la ubicación del sensor, la cantidad de luz directa del sol que éste recibe, el calor reflejado de las estructuras cercanas, etc.), **es posible que haya que ajustar la configuración inicial para alcanzar el rendimiento deseado**. Solar Sync se calibra fácilmente para una ubicación determinada ajustando las configuraciones de región y/o de ajuste de riego. Las siguientes instrucciones resumen dicho proceso:

1. Instale el sensor Solar Sync
2. Programe la región y deje que el sistema funcione con la configuración inicial durante un mínimo de 3 días (consulte la página 15 para obtener instrucciones sobre cómo determinar la configuración de Región adecuada).
3. Observe el ajuste estacional del programador. Si el ajuste estacional es menor o mayor de lo esperado para esa época del año, deberá ajustarse la configuración de Solar Sync.
 - a. **Ajuste estacional demasiado bajo:** Gire el dial hasta la posición Solar Sync Settings (configuración de Solar Sync). Aumente el valor de la escala de ajuste de riego (el valor máximo es 10). Tras cambiar la configuración, el programador se actualizará inmediatamente con el nuevo porcentaje del ajuste estacional. **Aumente la configuración del ajuste de riego hasta que aparezca el porcentaje de ajuste estacional deseado. Si llega al máximo de la escala de ajuste de riego (10) y aún requiere un mayor ajuste estacional, desplácese a la siguiente región menor (por ejemplo, de la región 4 a la 3).**
 - b. **Ajuste estacional demasiado alto:** Gire el dial hasta la posición Solar Sync Settings (configuración de Solar Sync). Reduzca el valor de la escala de ajuste de riego (el valor predeterminado es 5). Tras cambiar la configuración, el programador se actualizará inmediatamente con el nuevo porcentaje del ajuste estacional. Disminuya la configuración del ajuste de riego hasta que aparezca el porcentaje de ajuste estacional deseado. **Si llega al mínimo de la escala de ajuste de riego (1) y aún requiere un menor ajuste estacional, desplácese a la siguiente región mayor (por ejemplo, de la región 2 a la 3).**

Tiempos de riego: es importante comprender que Solar Sync proporciona al programador un ajuste estacional global. Esto quiere decir que todos los tiempos de riego se modificarán según el porcentaje de ajuste estacional mostrado. Al realizar la programación, deben introducirse los tiempos que representen los tiempos de riego más altos para cada estación. Si se ajusta Solar Sync según el valor estacional adecuado pero el tiempo de riego de una estación en concreto parece demasiado largo o corto, ajuste dicho tiempo de riego en el programa.

FUNCIÓN DE RETRASO SOLAR SYNC

Retraso Solar Sync para X-CORE®

La función de retraso solo está disponible después de instalar Solar Sync. La función de retraso Solar Sync permite al usuario posponer los cambios de ajuste estacional realizados por Solar Sync hasta por 99 días.

Cuando el retraso Solar Sync está activo, Solar Sync continuará recopilando y almacenando datos.

Funcionamiento:

Para acceder a la configuración del retraso Solar Sync:

1. Gire el dial hasta la posición RUN (AUTOMÁTICO); mantenga presionado el botón **+**, gire el dial a la posición Solar Sync y suelte el botón **+**. Se mostrará la siguiente pantalla: **d:XX** (donde d indica los días y **XX** indica el número de días de retraso).
2. Pulse el botón **+** o **-** para aumentar/disminuir el número de días de retraso. Cuando se muestre el número de días deseado, gire el dial a la posición RUN (AUTOMÁTICO) para activar el retraso.



NOTA: La cantidad de días restantes no se mostrará en la pantalla RUN (AUTOMÁTICO). Para verificar si la función de retraso está activa, abra el menú de retraso Solar Sync y compruebe el número de días mostrado. Si se muestran 1 o más días, entonces el retraso de Solar Sync está activo; si se muestra 00, entonces el retraso de Solar Sync no está activo.

Para cambiar la configuración de días de retraso:

1. Abra el menú de retraso Solar Sync presionando el botón **+**, gire el dial hasta la configuración de Solar Sync y suelte el botón **+**.
2. Utilice las teclas + o - para modificar el número de días hasta que se muestre el número de días de retraso deseado. (Configurar los días como 00 hace que el retraso Solar Sync esté apagado.)
3. Regrese el dial a la posición **RUN** (AUTOMÁTICO) para que los cambios tengan efecto.

Aunque el retraso de Solar Sync esté activo, Solar Sync continuará recopilando información meteorológica y calculará el valor de ajuste estacional. El ajuste estacional actualizado será aplicado una vez que los días de retraso Solar Sync lleguen a 00.

CONEXIÓN DE UN MANDO A DISTANCIA HUNTER

Conexión a un mando a distancia Hunter (no incluido)

El programador X-Core es compatible con mandos a distancia Hunter (no incluidos). El conexionado de cables SmartPort® (que se incluye en todos los mandos a distancia Hunter) permite un uso rápido y sencillo de los controles de Hunter. Los mandos a distancia Hunter le permiten utilizar el sistema sin tener que desplazarse hasta el programador.

Para instalar el conector SmartPort

1. Instale una "T" con rosca hembra de ½" en el conducto de cables (no incluido) aproximadamente 12 pulgadas bajo el X-Core.
2. Pase los cables rojo, blanco y azul del soporte por la base del adaptador en forma de "T" hacia el compartimento del cableado, tal como se muestra.

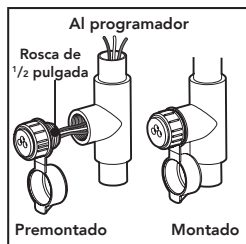

NOTA: P/N 258200 se puede utilizar como método alternativo para montar el conector SmartPort.

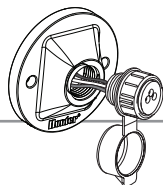

3. Atornille la caja del soporte SmartPort al adaptador en forma de "T", tal y como se muestra.
4. Conecte los cables rojo, blanco y azul de SmartPort al terminal del programador, tal y como se muestra:
 - Cable rojo al terminal "24VAC" del lado izquierdo
 - Cable blanco al terminal "24VAC" del lado derecho
 - Cable azul al terminal "REM"

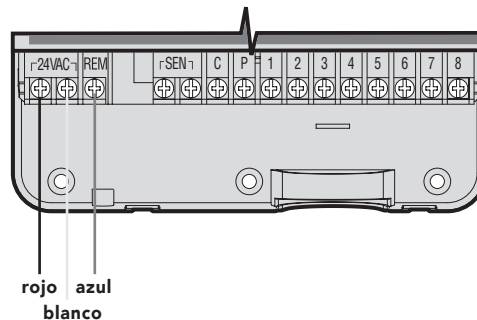

FALLOS DE ALIMENTACIÓN



Dado que existe la posibilidad de que se produzcan fallos de alimentación, el programador dispone de una memoria no volátil. La información programada no se pierde debido a fallos de alimentación. La pila de litio mantiene la hora correcta sin alimentación de CA. El riego normal se reanuda una vez restablecida la alimentación de CA.

AJUSTE DEL PROGRAMADOR

La pantalla de X-Core muestra la hora y el día cuando el programador está en reposo. La pantalla cambia cuando se gira el dial para indicar la información de programación específica que debe introducirse. Al establecer la programación, se puede cambiar la parte que parpadea de la pantalla pulsando los botones **+** o **-**. Para cambiar algún valor que no está parpadeando, pulse los botones **◀** o **▶** hasta que parpadee el campo deseado.

Tres programas, A, B y C, cada uno con la posibilidad de cuatro arranques diarios, permiten que las plantas con necesidades de riego diferentes cuenten con programas diarios independientes.

Configuración de la fecha y la hora

1. Gire el dial a la posición Dia/Hora (HORA/DÍA ACTUAL).
2. Parpadeará el año actual. Utilice los botones **+** y **-** para cambiar el año. Tras configurar el año, pulse el botón **▶** para continuar con la configuración del mes.
3. La pantalla mostrará el mes y el día. El mes parpadeará y se mostrará el icono . Utilice los botones **+** o **-** para cambiar el mes. Pulse el botón **▶** para continuar con la configuración del día.
4. El día parpadeará y se mostrará el icono . Utilice los botones **+** y **-** para cambiar el día. Pulse el botón **▶** para continuar con la configuración de la hora.
5. Se mostrará la hora. Utilice los botones **+** y **-** para seleccionar AM, PM o 24 horas. Pulse el botón **▶** para pasar a las horas. Las horas parpadearán. Utilice los botones **+** y **-** para cambiar la hora que se muestra en la pantalla. Pulse el botón **▶** para pasar a los minutos. Los minutos parpadearán. Utilice los botones **+** y **-** para cambiar los minutos que se muestran en la pantalla. La fecha, el día y la hora ya se encuentran configurados.



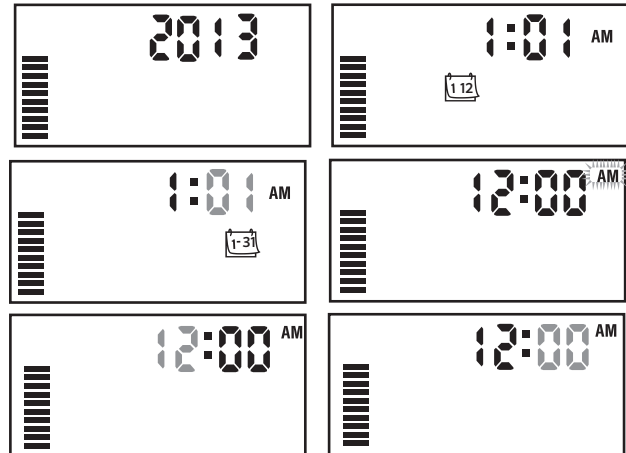

NOTA: Una regla de programación básica es que el símbolo o carácter que parpadea es el elemento que se está programando. Por ejemplo, si están parpadeando las cifras al establecer la hora, podrá cambiar o programar la hora. En este manual, los caracteres que parpadean se representan en color GRIS.



AJUSTE DEL PROGRAMADOR

Configuración de las horas de inicio del programa

1. Gire el dial hasta la posición **HOARS DE INICIO**.   **HOARS DE ARRANQUE**
2. El configuración de fábrica se establece en el programa A. Si es preciso, puede seleccionar el programa B o C pulsando el botón **PRO**.
3. Utilice los botones **+** y **-** para cambiar la hora de inicio. (Las horas de inicio avanzan en incrementos de 15 minutos).
4. Pulse el botón **▶** para añadir una hora de inicio adicional, o bien el botón **PRO** para pasar al siguiente programa.



NOTA: Una hora de inicio activa todas las estaciones secuencialmente del programa correspondiente. Esto elimina la necesidad de introducir la hora de inicio de cada estación. Pueden utilizarse múltiples horas de inicio en un programa para disponer de ciclos de riego para la mañana, la tarde o la noche. Las horas de inicio pueden introducirse en cualquier orden. X-Core los ordena automáticamente.

Eliminación de una hora de inicio



Con el dial en la posición **HOARS DE INICIO**, pulse el botón **+** o **-** hasta llegar a las 12:00 AM (medianoche). Desde esta posición, pulse el botón **-** una vez para configurarlo en OFF

Presione la flecha derecha para eliminar la segunda hora de inicio.









(APAGADO).

Configuración de los tiempos de riego

1. Gire el dial hasta la posición **TIEMPOS DE RIEGO**.   **TIEMPO DE RIEGO**
2. La pantalla mostrará el último programa seleccionado (A, B o C), el número de estación seleccionado, el icono , y la estación parpadeará. Puede cambiar a otro programa pulsando el botón **PRO**.
3. Utilice los botones **+** y **-** para cambiar el tiempo de riego de la estación en la pantalla. Puede establecer los tiempos de riego entre 0 y 4 horas.
4. Pulse el botón **▶** para avanzar a la siguiente estación.









Configuración de los días de riego

1. Gire el dial hasta la posición **DÍAS DE RIEGO**.   **DÍAS DE RIEGO**
2. La pantalla mostrará el último programa seleccionado (A, B o C). Puede cambiar a otro programa pulsando el botón **PRO**.
3. El programador mostrará los siete días de la semana (LUN, MAR, MIÉ, JUE, VIE, SÁB, DOM). Cada día tendrá un icono  o un icono  encima del día. El icono  representa un día de riego "On" (activado), mientras que el icono  representa un día de riego "Off" (desactivado).







AJUSTE DEL PROGRAMADOR

Selección de días de la semana específicos de riego

1. Con el cursor  en un día concreto (el cursor siempre empieza por LUN (Mo)), pulse el botón  para **activar el riego un día** concreto de la semana. Pulse el botón  para cancelar el riego de ese día. Tras pulsar el botón, el cursor avanzará automáticamente al día siguiente. 
2. Repita el paso 1 hasta haber seleccionado todos los días deseados. Los días seleccionados mostrarán  para indicar el estado ON (activado). El último  es el último día de riego para el programa en cuestión.

Selección de días pares o impares de riego

Esta función utiliza días numerados del mes para el riego en lugar de días específicos de la semana (días impares: 1, 3, 5, etc.; días pares: 2, 4, 6, etc.).





1. Presione la  flecha derecha hasta que el puntero esté sobre SU.
 2. Presione la flecha hacia la derecha una vez más, y Odd (Impar) aparecerá con el icono . Si se desea seleccionar días impares, gire el selector nuevamente a la posición de Riego. 
 3. Si desea riego en los días pares, presione el botón  una vez. Aparecerá el icono  y el mensaje **PAR**. Puede alternar entre **IMPAR** y **PAR** presionando los botones .
- 



NOTA: el día 31 de cualquier mes y el 29 de febrero son siempre días "off" (inactivos) si se selecciona el riego en días impares.

Selección de riego por intervalos

Esta opción le permite seleccionar riego por intervalos de 1 a 31 días.

1. Con el cursor en EVEN (PAR), pulse el botón  una vez, tras lo cual aparecerán en pantalla el icono  y un 1 parpadeando. El programa de riego por intervalos aparecerá en la pantalla. 
2. Pulse el botón  o  para seleccionar el número de días entre los días de riego (entre 1 y 31 días). Dicho número será el intervalo.

El programador regará conforme al programa seleccionado el siguiente arranque y luego regará con el intervalo programado.



Nota: Para salir del modo de intervalo (si no lo desea), presione el botón de la flecha izquierda hasta que se muestre de nuevo el día de la semana.

Configuración de días inactivos de eventos

X-Core le permite programar días de no riego. Esta función es útil para impedir el riego en días concretos. Por ejemplo, si siempre corta el césped los sábados, designará el sábado como día de no riego para evitar cortar hierba mojada.

1. Gire el dial hasta la posición **DÍAS DE RIEGO**.
2. Introduzca un programa de riego por intervalos, tal y como se describe en la página 19.
3. Pulse el botón  para ir hasta Días de **"no riego"**, situado en la parte inferior de la pantalla. **LUN (Mo)** parpadeará.

AJUSTE DEL PROGRAMADOR

- Utilice el botón ► hasta que el cursor se encuentre en el día de la semana que desee establecer como Día de no riego.
- Pulse el botón ■ para establecer este día como día de no riego. El icono ☹ se iluminará sobre este día.
- Repita los pasos 4 y 5 hasta que haya desactivado los días de evento deseados.



NOTA: en el programa de riego por intervalos, también puede optar por programar la desactivación en días impares o pares.

Riego automático

Tras programar X-Core, sitúe el dial en la posición **RIEGO** para permitir la ejecución automática de todos los programas de riego y arranques seleccionados.

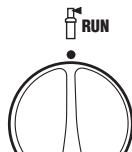



Sistema apagado

Las válvulas que estén en funcionamiento se cerrarán si el dial se coloca en la posición **SISTEMA APAGADO** durante dos segundos. Todos los programas activos se interrumpirán y se detendrá el riego. Para volver a establecer el funcionamiento automático habitual del programador, tan sólo tiene que girar el dial a la posición **RIEGO**.



Parada por lluvia programable

Esta característica permite al usuario detener todos los riegos programados durante un período designado de entre 1 y 7 días. Al final del período de parada por lluvia programable, el programador reanudará el funcionamiento automático normal.

- Gire el dial hasta la posición **SISTEMA APAGADO**. Espere a que aparezca **OFF** (APAGADO).
- Pulse el botón ■ tantas veces como sea necesario para establecer el número de días que debe permanecer apagado (hasta 7 días).
- Gire el dial de nuevo a la posición **RIEGO**, tras lo cual aparecerán en pantalla **OFF** (APAGADO), un número y los iconos  y .



Cada día a medianoche se reducirá el número de días inactivos restantes. Al llegar a cero, la pantalla mostrará la hora real del día y el riego normal se reanudará en el siguiente arranque programado.



Ajuste estacional %

El ajuste estacional se utiliza para realizar cambios globales en los tiempos de riego sin necesidad de volver a programar todo el programador. Para utilizar la función de ajuste estacional:

- Gire el dial hasta la posición **AJUSTE ESTACIONAL**.
- La pantalla mostrará un número parpadeando seguido de un signo %, además del gráfico de barras que siempre permanece en pantalla. Pulse el botón ■ o ■ para ajustar el porcentaje de ajuste estacional. Cada barra del gráfico representa el 10%. Esta función permite ajustar el programador entre el 10% y el 150% del programa original.



Para ver los tiempos de riego programados, simplemente gire el dial a la posición **TIEMPOS DE RIEGO**, tras lo cual el tiempo de riego mostrado se actualizará en función del ajuste estacional establecido.

AJUSTE DEL PROGRAMADOR



NOTA: el programador siempre debe programarse inicialmente en la posición del 100%.

Si se utiliza un sensor meteorológico “Clik” de Hunter, el valor de ajuste estacional podrá establecerse de la forma descrita.

Si se utiliza un sensor ET Solar Sync, el valor de ajuste estacional se actualizará a diario automáticamente en función del sensor Solar Sync. El sensor ET Solar Sync mide los patrones meteorológicos, determina el valor óptimo de ajuste estacional y actualiza el programador a diario. Este valor puede cambiarse manualmente pulsando los botones **+** o **-** para seleccionar el valor de ajuste estacional deseado. **No obstante, es importante tener en cuenta que el valor de ajuste estacional establecido manualmente será sustituido a medianoche por el nuevo valor actualizado procedente del sensor Solar Sync.**

Para regresar al modo de ajuste manual, es preciso desinstalar el sensor Solar Sync. Consulte la página 14 para obtener instrucciones de cómo desinstalar el sensor Solar Sync.

Riego manual de una estación

1. Gire el dial a la posición **MANUAL - ONE STATION (MANUAL - UNA ESTACIÓN)**.
2. El tiempo de riego de la estación parpadeará en la pantalla. Utilice el botón para desplazarse hasta la estación deseada. Puede utilizar el botón **+** o **-** para seleccionar el tiempo de riego de la estación.







MARCHA MANUAL - UNA ESTACIÓN 



3. Gire el dial en sentido horario hasta la posición **RUN (AUTOMÁTICO)** para poner en funcionamiento la estación (tan sólo regará la estación designada y, a continuación, el programador volverá al modo automático sin que se produzcan cambios en el programa establecido anteriormente). **Consulte también Arranque y avance manual con una tecla.**

Arranque y avance manual con una tecla



También puede activar todas las estaciones para que rieguen sin utilizar el dial.

1. Mantenga pulsado el botón  durante 2 segundos.
2. Esta función utiliza de forma predeterminada el programa A. Puede seleccionar el programa B o C pulsando el botón .
3. El número de la estación parpadeará. Pulse el botón  para desplazarse por las estaciones y utilice el botón **+** o **-** para ajustar los tiempos de riego de la estación. (Si no se pulsa ningún botón durante varios segundos mientras se realizan los pasos 2 o 3, el programador comenzará a regar automáticamente).
4. Pulse el botón  para desplazarse a la estación con la que desea comenzar. Tras una pausa de 2 segundos, se iniciará el programa. En cualquier momento durante el ciclo manual, podrá utilizar los botones  o  para desplazarse manualmente de una estación a otra.

CARACTERÍSTICAS AVANZADAS

Anulación del sensor programable

El programador X-Core permite al usuario programar de forma que el sensor desactive el riego sólo en las estaciones deseadas. Por ejemplo, las macetas situadas bajo salientes y tejados en jardines de patios pueden no recibir el agua de la lluvia, de modo que seguirán necesitando el riego durante los períodos de lluvia. Para programar la anulación del sensor:

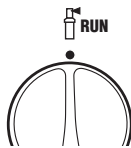

1. Gire el dial hasta la posición **RIEGO**.
2. Mantenga pulsado el botón  a la vez que gira el dial hasta la posición **HORAS DE INICIO**.
3. Suelte el botón . En este momento, la pantalla mostrará el número de estación, ON y el icono  parpadearán.



4. Pulse el botón  o  para activar o desactivar el sensor de la estación mostrada.

ON (ENCENDIDO) = Sensor activado
(suspenderá el riego)

OFF (APAGADO) = Sensor desactivado
(permitirá el riego)

5. Utilice los botones  o  para desplazarse a la estación siguiente en la que desee programar la anulación del sensor.





Sensor activado



Sensor desactivado





NOTA: la configuración predeterminada del programador hace que el sensor desactive el riego en todas las zonas cuando llueve.

Cuando el X-Core recibe una entrada del sensor para desactivar el riego, la pantalla indica las estaciones que se han programado para anular el sensor. Cuando una estación funcione en el modo de anulación del sensor, se mostrarán los iconos  y  parpadearo alternativamente.





Programa de prueba de todas las estaciones

El programador X-Core ofrece al usuario un método simplificado para ejecutar un programa de prueba. Esta función hace que cada estación opere en una secuencia numérica, del más bajo al más alto.

1. Con el dial en la posición **RUN (AUTOMÁTICO)** mantenga presionado el botón . Se mostrará el número de estación y la hora parpadeará por dos segundos.
2. Utilice los botones  o  para establecer el tiempo de riego entre 1 y 15 minutos. Sólo es necesario introducir el tiempo de riego una vez.
3. El programa de prueba comenzará tras una pausa de 2 segundos.

Diagnostico rápido de Hunter

Esta función le permite diagnosticar rápidamente los problemas de cableado con el programador. En lugar de comprobar cada circuito de cableado en busca de posibles problemas, puede utilizar el procedimiento de diagnóstico Quick Check de Hunter. Para iniciar el procedimiento de diagnóstico Quick Check:

1. Pulse los botones , ,  y  simultáneamente. En el modo de espera, la pantalla LCD mostrará todos los segmentos.
2. Pulse el botón  una vez para comenzar el procedimiento de Quick Check. En unos segundos, el sistema detecta cualquier problema en los circuitos de todas las estaciones. Cuando se detecta un cortocircuito en el cableado, un símbolo ERR precedido del número de la estación parpadea momentáneamente en la pantalla. Una vez que la función Quick Check finaliza el procedimiento de diagnóstico de los circuitos, el programador vuelve al modo de riego automático.

CARACTERÍSTICAS AVANZADAS

Memoria de programas Easy Retrieve™

El programador X-Core posee la capacidad de guardar el programa de riego preferido en la memoria para su posterior recuperación. Esta función ofrece una forma rápida de restablecer el programa de riego introducido originalmente.

Para guardar el programa en la memoria

1. Con el dial en la posición **RIEGO**, mantenga pulsados los botones **+** y **PRG** durante 5 segundos. La pantalla desplazará tres segmentos **≡** de izquierda a derecha por la pantalla, indicando que el programa se está guardando en la memoria.
2. Suelte los botones **+** y **PRG**.

Para recuperar un programa guardado anteriormente en la memoria:

1. Con el dial en la posición **RIEGO**, mantenga pulsados los botones **-** y **PRG** durante 5 segundos. La pantalla desplazará tres segmentos **≡** de derecha a izquierda por la pantalla, indicando que el programa se está recuperando de la memoria.
2. Suelte los botones **-** y **PRG**.

Retraso programable entre estaciones

Esta característica permite al usuario insertar un retraso entre la desactivación de una estación y la activación de la siguiente.

1. Comience con el dial en la posición **RIEGO**.
2. Mantenga pulsado el botón **-** a la vez que gira el dial hasta la posición **TIEMPOS DE RIEGO**.
3. Suelte el botón **-**. Llegado este punto, la pantalla mostrará intermitentemente un período de retardo en segundos para todas las estaciones.

4. Presione los botones **+** o **-** para aumentar o disminuir el tiempo de retraso entre 0 segundos y 4 horas.
5. Vuelva a colocar el dial en la posición **RIEGO**.

Borrado de la memoria del programador/ Restablecimiento del programador

Si considera que su programador no está correctamente programado, dispone de un proceso que le permitirá restablecer la memoria a la configuración predeterminada de fábrica y borrar todos los programas y datos que se hayan introducido en el programador.

1. Mantenga pulsado el botón **PRG**.
2. Mientras mantiene presionado el botón **PRG**, presione y libere el botón en el lado derecho del programador.
3. Mantenga presionado el botón **PRG** hasta que se muestre la hora 12:00 AM (suele tardar alrededor de 8 segundos).

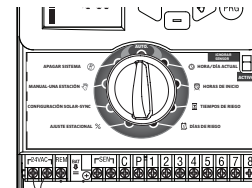



Reinicio

INSTRUCCIONES DE RETRASO CLIK

Función de Retraso Clik

Esta función permite que el usuario retrase los riegos programados en un periodo designado (de 1 a 7 días) DESPUÉS de que termine un evento Clik. Al final del periodo de retraso programado Clik, el programador reanudará el riego normal automático.

1. Gire el dial a la posición **RUN** (AUTOMÁTICO)
2. Mantenga presionado el botón  durante 3 segundos, después gire el dial hasta la posición **APAGADO**
3. Libere el botón . La pantalla mostrará el Retraso Clik programable.



4. Presione el botón  para configurar la duración del retraso Clik (de 1 a 7 días).
5. Regrese el dial a la posición **RUN** (AUTOMÁTICO). El Retraso Clik está configurado.



Al terminar el evento Clik (el sensor de lluvia pasa de mojado a seco), la función Retraso Clik se activará y la pantalla mostrará la duración del retraso Clik. La cuenta atrás de días ocurrirá 24 horas después de iniciar el Retraso Clik.

Se puede cancelar un Retraso Clik girando el dial a la posición **APAGADO**, esperando a que APAGADO deje de parpadear y después volviendo a girar el dial hasta la posición **RUN** (AUTOMÁTICO).

Cualquier estación que esté configurada para anular el sensor y los programas de iluminación operará durante un evento de retraso Clik.



NOTA: Tenga cuidado cuando utilice la función programable de Retraso Clik con Hunter Wind-Clik®, Freeze-Clik®, Soil- Clik, y el componente de congelación de Solar Sync y Rain/Freeze Clik, dado que el Retraso Clik se activará DESPUÉS de un evento Clik desde estos dispositivos.

CARACTERÍSTICAS OCULTAS

Personalización de programas

El X-Core está configurado de fábrica con tres programas independientes (A, B, C) con cuatro horas de arranque cada uno) para distintas necesidades según el tipo de planta. El X-Core se puede personalizar para mostrar un solo programa y una hora de arranque, ocultando los programas y horas de arranque adicionales innecesarios para facilitar su programación.

1. Comience con el dial en la posición **RIEGO**.
2. Pulse y mantenga pulsado el botón -. Gire el dial hasta la posición **DÍAS DE RIEGO**.
3. Suelte el botón -.
4. Utilice los botones + y - para cambiar los modos del programa.

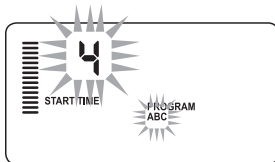

Modo normal
(3 programas / 4 horas de arranque)

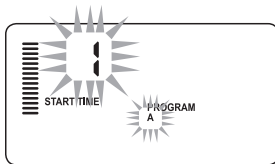

Modo limitado
(1 programa / 1 hora de arranque)

FUNCIONES AVANZADAS (CONTINUACIÓN)

Ciclo e infiltración

La función Ciclo e infiltración le permite dividir el tiempo de riego de cada estación en periodos de riego más cortos y útiles. Esta característica es particularmente útil cuando se aplica agua en desniveles y suelos compactados, ya que el agua se aplica más lentamente, ayudando así a prevenir la escorrentía. La duración del Ciclo se debe introducir como una fracción del tiempo de riego de la estación y el tiempo de infiltración como el número mínimo de minutos necesario antes de que tenga lugar el riego del siguiente Ciclo. El número total de ciclos se determina dividiendo el tiempo de riego total programado de la estación entre el tiempo del Ciclo.

Acceso al menú Ciclo e infiltración:

Para acceder a la función de Ciclo e infiltración, gire el dial a la posición **RUN** (AUTOMÁTICO) y mantenga presionado el botón **+** durante 3 segundos; mientras presiona el botón **+** gire el dial a la posición **TIEMPO DE RIEGO** y después suelte el botón.

Configuración de la duración del ciclo:

Al principio se mostrará la Estación 1: Para acceder a otras estaciones, presione el botón ◀ o ▶.

Una vez que se muestra la estación deseada, pulse el botón **+** o **-** para aumentar o reducir la duración del ciclo. El usuario puede definir la duración del ciclo desde 1 minuto hasta 4 horas, en incrementos de 1 minuto; o seleccionar **APAGADO** si no desea que haya un ciclo.



NOTA: Por debajo de una hora de duración, solo se muestran los minutos (p. ej. 36). Al llegar a una hora o más, la pantalla cambiará para incluir el dígito de hora (p. ej. 1:13 y 4:00). Si el tiempo de riego de una estación es menor o igual que el tiempo del ciclo, no se aplicará ningún ciclo.

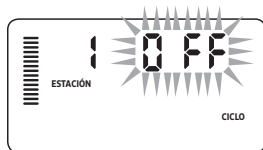

Ejemplo de pantalla de ciclo al entrar

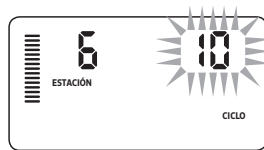

Ejemplo de pantalla de ciclo solo con minutos



Ejemplo de pantalla de ciclo con horas incluidas

FUNCIONES AVANZADAS (CONTINUACIÓN)

Acceso al menú de infiltración:

Una vez que se ha programado la duración deseada para el ciclo de cada estación, se puede acceder a la duración del ciclo pulsando el botón **PRG**.

Se mostrará la misma estación que en la pantalla de duración del ciclo (es decir, si se muestra la estación 2 en el menú de ciclo, entonces la estación 2 se mostrará al pulsar el botón **PRG**).



NOTA: No se puede acceder al menú de infiltración sin un tiempo de ciclo programado.

Configuración del tiempo de infiltración:

Para acceder a las otras estaciones, pulse el botón **◀◀▶▶**.



NOTA: Cuando cambia las estaciones, si se encuentra una estación sin ciclo, la pantalla volverá al tiempo de ciclo. Avance hasta la siguiente estación con un tiempo de ciclo y pulse el botón **PRG** para regresar.

Una vez se muestra la estación deseada, el usuario puede utilizar los botones **+** o **-** para aumentar o reducir el tiempo de infiltración.

El usuario puede definir el tiempo de infiltración desde 1 minuto hasta 4 horas en incrementos de 1 minuto.



NOTA: Por debajo de una hora de duración, solo se muestran los minutos (p. ej. 36). Al llegar a una hora o más, la pantalla cambiará para incluir el dígito de hora (p. ej. 1:13 y 4:00).



Ejemplo de pantalla de infiltración solo con minutos



Ejemplo de pantalla de infiltración con horas incluidas

Situaciones de ciclo e infiltración:

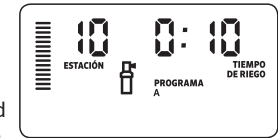

La Estación 1 requiere 20 minutos de riego, pero tras 5 minutos hay escorrentía. Sin embargo, tras 10 minutos se habrá absorbido todo el agua. La solución consiste en programar 20 minutos para el tiempo de riego de la estación, 5 minutos de Ciclo y 10 minutos de infiltración.

El tiempo de infiltración es una cantidad mínima. El tiempo de infiltración puede ser una cantidad mayor dependiendo de los tiempos de riego restantes.





Ciclo de la estación 10 en funcionamiento

GUÍA DE RESOLUCIÓN DE PROBLEMAS

Problema	Causas	Soluciones
El programador riega continuamente	Se han programado demasiadas horas de inicio	Sólo es necesario un arranque para activar un programa (consulte Configuración de las horas de inicio del programa en la página 18)
No aparece nada en pantalla	Compruebe el cableado de la alimentación	Corrija cualquier error existente
En la pantalla aparece “No AC”	No hay suministro de corriente (el programador no recibe suministro eléctrico)	Compruebe que el transformador se encuentra correctamente instalado
En la pantalla aparece “Off,   “	El sensor de lluvia interrumpe el riego o se ha retirado el puente del sensor	Deslice el interruptor de anulación del sensor de lluvia a la posición BYPASS (ANULAR) para anular el circuito del sensor de lluvia, o reinstale el puente
El sensor de lluvia no apaga el sistema	<ul style="list-style-type: none"> • El sensor de lluvia está defectuoso • No se ha retirado el puente al instalar el sensor • Las estaciones se han programado para que anulen el sensor 	<ul style="list-style-type: none"> • Compruebe el funcionamiento del sensor de lluvia y que el cableado sea correcto • Retire el puente de los terminales del sensor • Reprograme la anulación del sensor de manera que el sensor quede activado (consulte la página 11)
Pantalla congelada o con información incorrecta	Sobrecarga de tensión	Restablezca el programador conforme a lo indicado en la página 24, “Borrado de la memoria del programador/Restablecimiento del programador”
La pantalla muestra “ERR” con un número (del 1 al 8)	Cortocircuito en el cableado de la válvula o solenoide defectuoso en el número de estación indicado	Compruebe el circuito de cableado o el solenoide correspondiente al número de estación indicado. Repare el cortocircuito o sustituya el solenoide. Pulse cualquier botón para borrar “ERR” de la pantalla
La pantalla muestra “P ERR”	<ul style="list-style-type: none"> • Relé de bomba o cableado de válvula maestra defectuoso • Relé o solenoide incompatible o defectuoso • El cable que va al relé de la bomba o a la válvula maestra es de tamaño inferior al necesario 	<ul style="list-style-type: none"> • Compruebe el cableado que va al relé o al solenoide de la válvula maestra. Pulse cualquier botón para borrar “P ERR” de la pantalla • Compruebe la especificación eléctrica para el relé de la bomba. No exceda la capacidad eléctrica del programador. Sustitúyalo si está defectuoso • Sustituya el cable por otro de mayor calibre

GUÍA DE RESOLUCIÓN DE PROBLEMAS

Problema	Causas	Soluciones
La pantalla indica que una estación está regando pero los iconos  y  parpadean	El sensor está interrumpiendo el riego, pero la estación ha sido programada para anular el sensor	Compruebe el estado de anulación del sensor (consulte la página 23)
El riego automático no comienza a la hora de inicio y el programador no está en modo de Sistema apagado	<ul style="list-style-type: none"> • No se ha establecido correctamente AM/PM para la hora del día • No se ha establecido correctamente AM/PM para la hora de inicio • Hora de inicio está desactivada (configurado con el valor Off: Apagado) • El programador no está recibiendo alimentación de CA 	<ul style="list-style-type: none"> • Corrija el valor de AM/PM de la hora del día • Corrija el valor de AM/PM de la hora de inicio • Consulte Configuración de las horas de inicio (página 18) • Compruebe las conexiones de alimentación de CA
La pantalla muestra guiones cuando el dial se sitúa en la posición Configuración de Solar Sync	<ul style="list-style-type: none"> • El sensor Solar Sync no está conectado al programador • Es posible que los cables del sensor Solar Sync estén cortados o que tengan una conexión defectuosa 	Conecte Solar Sync a las posiciones “SEN” en el terminal de cableado. La pantalla mostrará entonces los valores de Región y Ajuste de riego.
Los tiempos de riego para una estación concreta son demasiado cortos/largos cuando se utiliza un sensor Solar Sync	El periodo de riego está programado con tiempos demasiado largos/cortos	Solar Sync proporciona al programador un ajuste estacional global. Si los periodos de riego para una estación determinada son demasiado cortos o largos, realice los ajustes necesarios en el programador. Asegúrese de que cambia el ajuste estacional de nuevo al 100% antes de realizar cambios en los tiempos de riego de los programas. Para ello, gire el dial a la posición Ajuste estacional y aumente/disminuya el valor al 100%.
El ajuste estacional parece bajo	<ul style="list-style-type: none"> • Región demasiado alta • Ajuste de riego demasiado bajo • La ubicación del sensor no permite que le llegue toda la luz solar 	Aumente el valor de la escala de ajuste de riego (el valor predeterminado es 5). Si el valor máximo de 10 en la escala de Ajuste de riego resulta insuficiente y sigue necesitando más ajuste estacional, baje una región (de la 4 a la 3, por ejemplo) y comience con el valor 5 de Ajuste de riego. Solar Sync actualizará de inmediato el Ajuste estacional en el programador. Si el ajuste estacional sigue siendo demasiado bajo, repita la acción hasta que el programador muestre el ajuste estacional deseado.

GUÍA DE RESOLUCIÓN DE PROBLEMAS

Problema	Causas	Soluciones
El ajuste estacional parece alto	<ul style="list-style-type: none"> • Región demasiado baja • Configuración del ajuste de riego demasiado alta 	Disminuya el valor de configuración del ajuste de riego. Si el valor mínimo de 1 en la escala de Ajuste de riego resulta excesivo y sigue necesitando menos ajuste estacional, suba una región (de la 2 a la 3, por ejemplo) y comience con el valor 5 de Ajuste de riego. Solar Sync actualizará de inmediato el Ajuste estacional en el programador. Si el ajuste estacional sigue siendo demasiado alto, repita la acción hasta que el programador muestre el ajuste estacional deseado.
Solar Sync continúa enviando el ajuste estacional con el interruptor de anulación del programador en la posición “Bypass” (Anular)	El ajuste estacional automático de Solar Sync no se desactiva mediante el interruptor de anulación. El interruptor de anulación sólo controla el cierre automático por lluvia/helada de Solar Sync.	

ESPECIFICACIONES

Especificaciones de funcionamiento

- Tiempos de riego de las estaciones: de 0 a 4 horas en incrementos de 1 minuto
- 3 programas de riego independientes
- Arranques: 4 al día por programa para un máximo de 12 arranques diarios
- Programa de riego: calendario de 365 días, riego por intervalos, riego en pares/impares
- Reloj AM/PM y de 24 horas
- Funcionamiento manual sencillo
- Anulación del sensor por estación
- Retraso por lluvia programable (de 1 a 7 días)
- Ajuste estacional manual (del 10% al 150%)
- Ajuste estacional automático mediante sensor Solar Sync
- Interruptor de bypass del sensor
- X-Core-x00i para uso en interior. X-Core-x00 para uso en exterior
- Del nivel del mar a 2000 m (6500 pies) con una temperatura entre -25° C y 60° C (entre -13° F y 140° F)

Dimensiones

Caja interior

- Altura: 16.5 cm
- Ancho: 14.6 cm
- Profundidad: 5 cm

Caja exterior

- Altura: 22 cm
- Ancho: 17.8 cm
- Profundidad: 9.5 cm

Especificaciones eléctricas

- Entrada del transformador de 120 VCA $\pm 10\%$ 60 Hz (Modelos internacionales de 230 VCA $\pm 10\%$ 50/60 Hz)
- Salida del transformador: 24 VCA 1,0 amp.
- Salida de las estaciones: 0,56 amp. por estación
- Salida máxima: 0,90 amp. (incluida la válvula maestra)
- Pila: de litio de 3 V (incluida) para programación remota y mantenimiento de la hora. Utilice CR2032 de 3 voltios.
- Protección electrónica contra cortocircuitos
- Memoria no volátil para datos de programas
- Aprobado por UL
- El modelo X-Core-x00 tiene un nominal IP2X
- Límpielo exclusivamente con un paño humedecido en agua y jabón suave

Explicación de los símbolos











~ = CA

 = Consultar documentación







 = Presencia de tensiones peligrosas

 = Toma de tierra

TABLE DES MATIÈRES

COMPOSANTS DU PROGRAMMATEUR X-CORE	2	Réglage des jours d'arrosage 	19
MONTAGE MURAL	6	Sélection des jours spécifiques de la semaine pour arroser	19
RACCORDEMENT DES VANNES ET DU TRANSFORMATEUR	7	Sélection des jours pairs ou impairs pour arroser	20
ACTIVATION DE LA PILE	8	Sélection des intervalles entre arrosages 	20
REMPLACEMENT DE LA PILE	8	Réglage des jours sans arrosage	20
BRANCHEMENT D'UNE VANNE MAÎTRESSE	9	Arrosage automatique 	20
BRANCHEMENT D'UN RELAIS DEMARRAGE DE POMPE	10	Arrêt du système 	20
RACCORDEMENT DES SONDES METEOROLOGIQUES	11	Suspension de l'arrosage.....	21
Test des Sondes Météorologiques.....	11	Réglage saisonnier %	21
PARAMÈTRES SOLAR SYNC	11	Lancement manuel d'une seule station 	21
Installation du capteur Solar Sync	12	Touche unique démarrage manuel	21
Installation du récepteur Wireless Solar Sync	12	FONCTIONS AVANCÉES	22
Paramètres Solar Sync	12	Désactivation d'une sonde	
Region 	13	météorologique programmable	23
PROGRAMMATION DU MODULE SOLAR SYNC	14	Programme test de toutes les stations.....	23
Ajustement de l'arrosage 	14	Vérification Rapide Diagnostics (Quick Check™)	23
Désinstallation d'un capteur Solar Sync.....	14	Mémoire de programme Easy Retrieve™	
Période de configuration/étalonnage	15	(facile à récupérer)	24
FONCTIONNALITÉ DE DÉLAI SOLAR SYNC	16	Délai programmable entre stations.....	24
CONNEXION À UNE TÉLÉCOMMANDE HUNTER	17	Effacer la mémoire du programmeur/ Remise à zéro	
Connexion à une télécommande Hunter (non incluse)	17	du programmeur.....	24
Pour installer le connecteur SmartPort	17	Instructions pour le délai Klik	25
COUPURES DE COURANT	17	Personnalisation de programme	26
LA PROGRAMMATION	18	Arrosage et réessuyage.....	27
Réglage du jour et de l'heure 	19	GUIDE DE DÉPANNAGE	28
Réglage des départs de cycle 	19	SPECIFICATIONS	31
Suppression d'un départ de cycle programmé.....	19	CERTIFICAT DE CONFORMITÉ AUX DIRECTIVES	
Réglage des temps d'arrosage 	19	ET NORMES D E LA COMMUNAUTE EUROPÉENNE	32

COMPOSANTS DU PROGRAMMATEUR X-CORE

A Écran à cristaux liquides		
1	 Temps d'arrosage	Permet à l'utilisateur de programmer le temps d'arrosage par station de 1 minute à 4 heures
2	 Départs de cycle	Permet 1 à 4 départs de cycle pour chaque programme
3	Numéro de station	Indique le numéro de la station actuellement sélectionnée
4	Identificateur du programme	Identifie le programme utilisé A, B ou C
5	Jour de la semaine	Chaque jour de la semaine est identifié
6	Calendrier mensuel	Cette icône apparaît lors de la programmation du mois courant
7	Arrosage pair/impair	Visualise si l'arrosage pair ou impair a été sélectionné. Even = pair/Odd = impair
8	Arroseur clignotant	Indique que l'arrosage est en cours
9	 Arrêt du système	Indique l'arrêt de l'arrosage
10	 Parapluie	Indique qu'une sonde a coupé l'arrosage
11	% Réglage saisonnier	Indique le pourcentage du réglage saisonnier. Les barres sur la gauche offrent un repère visuel rapide sur le pourcentage de réglage saisonnier
12	 Goutte de pluie	Indique que l'arrosage s'effectuera le jour sélectionné
13	 Goutte de pluie barrée	Indique que l'arrosage NE S'EFFECTUERA PAS le jour sélectionné
14	 Calendrier	Indique l'intervalle entre arrosages programmé. Cette icône apparaît également lors de la programmation du jour courant

COMPOSANTS DU PROGRAMMATEUR X-CORE

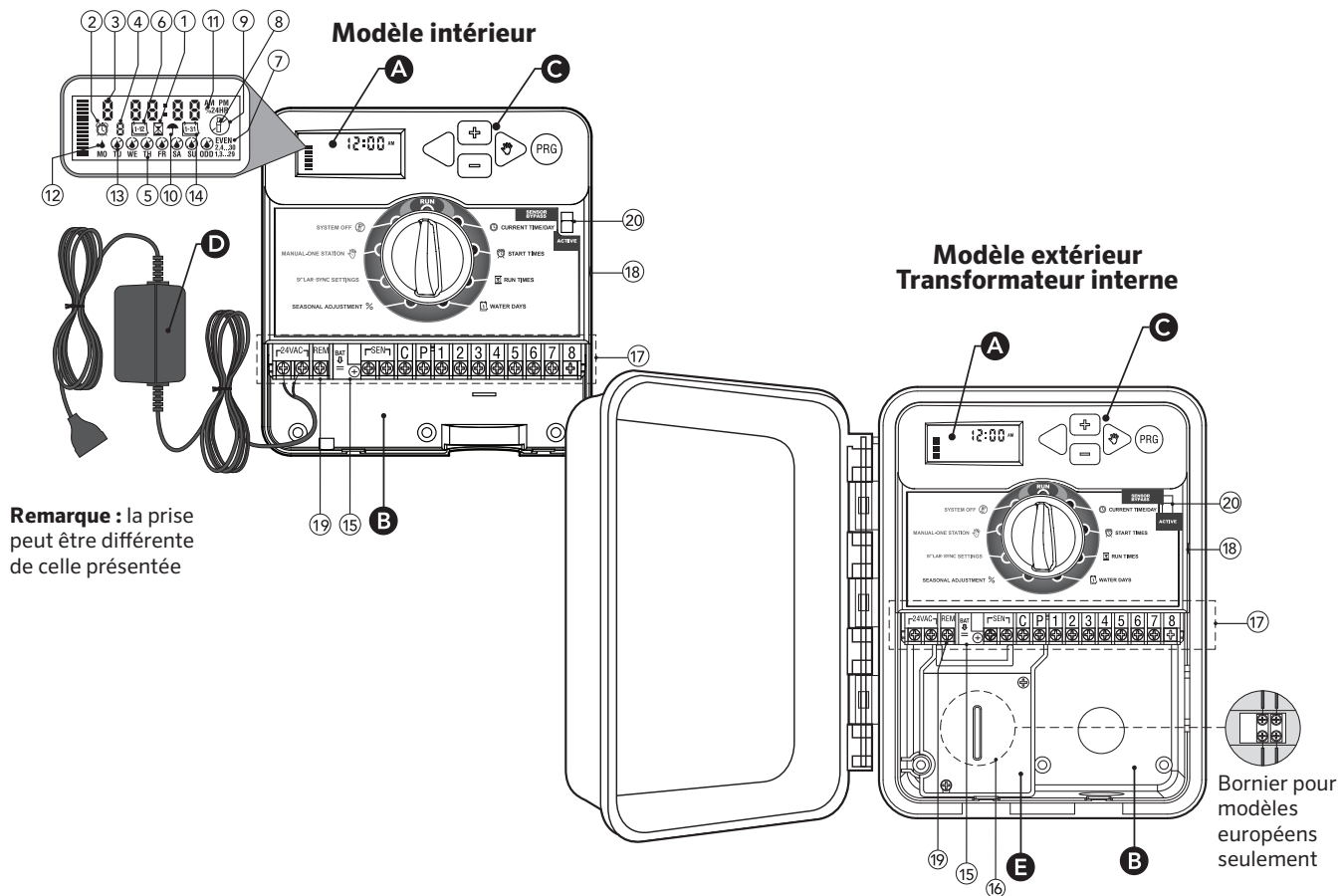







COMPOSANTS DU PROGRAMMATEUR X-CORE

B Compartiment câblage		
15	Pile au lithium	En l'absence d'alimentation secteur, la pile au lithium (remplaçable et fournie) peut être utilisée pour effectuer la programmation. En plus, la pile fournira de l'alimentation pour conserver l'heure en cas de coupure de courant
16	Boîtier de raccordement interne	Boîtier de raccordement sur les modèles extérieurs permettant les branchements d'alimentation 220 volts
17	Bornier de raccordement	Pour raccorder les fils du transformateur et des vannes au programmeur
18	Touche de réinitialisation	Permet de réinitialiser le programmeur (sur le côté droit du programmeur)
19	REM	Autorise les connexions avec les connecteurs Hunter SmartPort® et les télécommandes Hunter
20	Interrupteur de contournement de la sonde	Ignore l'entrée du capteur météorologique « Klik » en mode de bypass
C Touches de commande		
	+ Touche	Augmente l'affichage clignotant sélectionné
	- Touche	Diminue l'affichage clignotant sélectionné
	◀ Touche	Permet de faire revenir l'affichage clignotant au précédent
	▶ Touche	Permet de faire avancer l'affichage clignotant au suivant
	PRG Touche	Sélectionne le programme A, B ou C pour différents besoins en arrosage

COMPOSANTS DU PROGRAMMATEUR X-CORE

Commande par sélecteur / Signification des symboles

	Marche (run)	Position normale du sélecteur pour tous les modes de fonctionnement du programmeur (automatique et manuel)
	Réglage Heure/Jour	Permet de régler le jour et l'heure
	Réglage Départs Cycle	Permet 1 à 4 départs pour chaque programme
	Réglage Temps d'arrosage	Permet de programmer chaque station de 1 minute à 4 heures
	Réglage Jours d'arrosage	Permet de sélectionner les jours de la semaine ou un nombre de jours entre chaque arrosage (intervalle)
%	Réglage Saisonnier	Permet de modifier les temps d'arrosage en fonction des besoins sans reprogrammer. Les barres sur la gauche offrent un repère visuel sur le pourcentage de réglage saisonnier
	Marche Manuelle - Une Station	Permet de lancer l'arrosage pour une seule station
	Arrêt	Permet d'interrompre tous les programmes et de couper l'arrosage. Il permet également de programmer un arrêt de l'arrosage pour une période de 1 à 7 jours
	SOLAR SYNC® Paramètres	Permet aux utilisateurs de programmer les paramètres lors de l'utilisation du capteur ET Solar Sync
D Transformateur (Modèle intérieur seulement)		
		Une prise incorporée au transformateur est fournie pour le branchement au secteur du programmeur

MONTAGE MURAL



Remarque : Le modèle X-Core intérieur n'est pas étanche ni résistant aux intempéries. Il doit donc impérativement être installé à l'intérieur ou dans un endroit abrité.

1. Visser une vis dans le mur. Pour la fixation du programmateur, utiliser des chevilles, si nécessaire.
2. Faire glisser l'encoche située en haut du programmateur sur la vis.
3. Fixer le programmateur en mettant 3 vis dans les trous situés sous la zone du bornier de raccordement.



Remarque : Ne jamais alimenter le transformateur avant que le programmateur ne soit monté et toutes les vannes ne soient branchées.



Remarque : Pour le XC - x01 - A : Si le cordon d'alimentation est endommagé, il doit être remplacé par le fabricant, un technicien de maintenance ou toute autre personne qualifiée, pour des raisons de sécurité.



Remarque : Sur les unités extérieures, la porte doit rester fermée pour une étanchéité maximale.

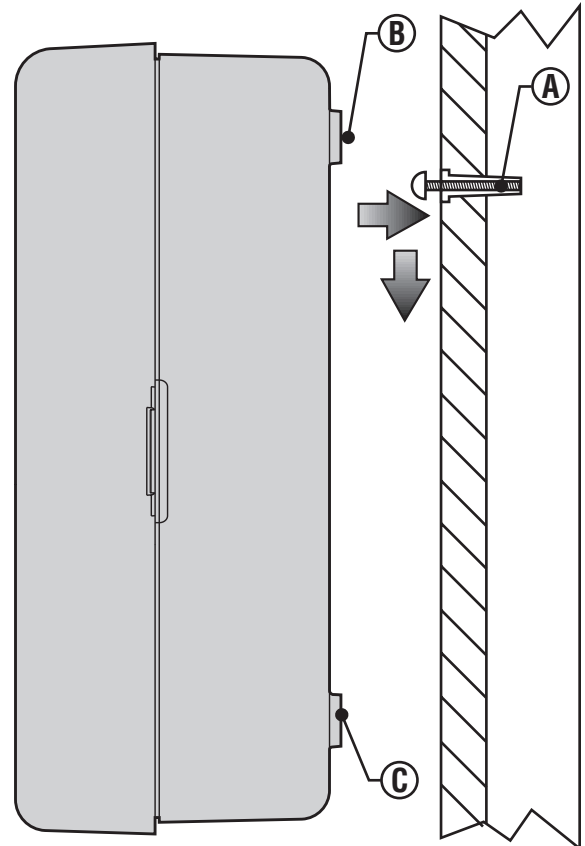

RACCORDEMENT DES VANNES ET DU TRANSFORMATEUR

L'installation du programmeur X-Core doit être impérativement faite par du personnel qualifié.

1. Tirer les câbles des vannes jusqu'au programmeur.
2. Au niveau des vannes, raccorder le commun à l'un des fils du solénoïde de chacune des vannes. Relier un câble séparé au deuxième fil du solénoïde. Repérer chaque câble et le numéro de la station correspondante. Relier les câbles avec des connecteurs étanches pour éviter les fuites de courant.
3. Passer les câbles des vannes à travers le tube. Fixer le tube par le côté inférieur droit du programmeur.
4. Fixer le commun blanc des vannes sur la vis de la borne C (commun) du bornier. Relier les câbles de chaque vanne aux bornes de leurs stations correspondantes puis serrer les vis.
5. **Modèles intérieur :** faire passer le câble du transformateur par l'ouverture située à gauche du programmeur et raccorder les fils aux deux vis marquées 24 Volts.



Remarque: Vous ne devez pas couper le câble du transformateur d'intérieur. Si le câble est coupé, vous devrez raccorder ses fils rouge et blanc, sans quoi le programmeur ne fonctionnera pas.

Modèle extérieur : les câbles du transformateur sont déjà raccordés aux bornes AC afin qu'il ne reste plus qu'à brancher l'alimentation principale à la boîte de raccordement depuis une source d'alimentation 220 Volts.



Remarque : Le modèle X-Core extérieur est étanche et résistant aux intempéries. Le branchement du X-Core extérieur à l'alimentation générale doit être fait par un électricien agréé. Une mauvaise installation peut produire un choc électrique ou un court-circuit.

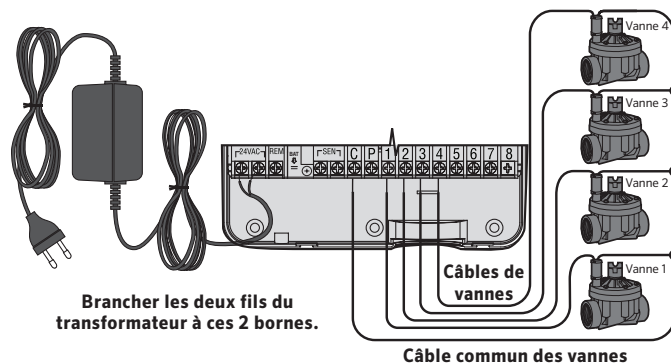

E Compartiment de raccordement 220 Volts (Modèle extérieur seulement)

1. Amener le câble électrique d'alimentation générale et le tube dans le passage en bas à gauche du boîtier.
2. Raccorder un fil à chacun des deux fils à l'intérieur du boîtier de raccordement. Le câble de mise à terre doit être branché au câble vert. Des dominos sont fournis pour faire les connexions. **Remarque :** Pour les modèles européens (indiqué -E à la fin de la référence), connecter les fils à la borne qui se trouve à l'intérieur du boîtier de raccordement. Les câbles d'alimentation de courant doivent être de dimension 1,85 mm ou plus avec un disjoncteur adapté à la dimension du câble. Un interrupteur ou disjoncteur doit être en proche proximité du programmeur dans l'immeuble où l'installation a lieu et facile d'accès pour l'opérateur. De plus il doit être indiqué comme étant le mécanisme de déconnexion de l'appareil.
3. Remettre le couvercle du boîtier de raccordement.

ACTIVATION DE LA PILE

Après l'installation de votre programmeur X-Core, veiller à retirer l'isolateur de contact de la pile pour permettre au programmeur X-Core de conserver l'heure en cas de coupure de courant.

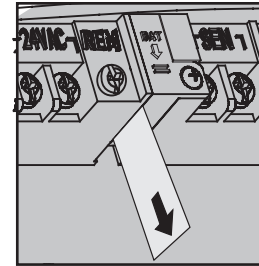

ATTENTION :
RISQUE D'EXPLOSION SI VOUS REMPLACEZ LA
BATTERIE PAR UN MODÈLE NON ADÉQUAT. JETER
LES BATTERIES SUIVANT LES INSTRUCTIONS.

REMPACEMENT DE LA PILE

Une pile au lithium est fournie avec votre programmeur X-Core. Elle permet la programmation à distance sans que l'alimentation 220 Volts ne soit branchée. Elle permet également de conserver la date et l'heure durant les coupures de courant. Pour remplacer la pile :

1. Retirer les vis du support de pile.
2. Descendre le support pour accéder à la pile.
3. Enlever la pile usée et la remplacer par une nouvelle; ensuite réinstaller le support avec la pile neuve.

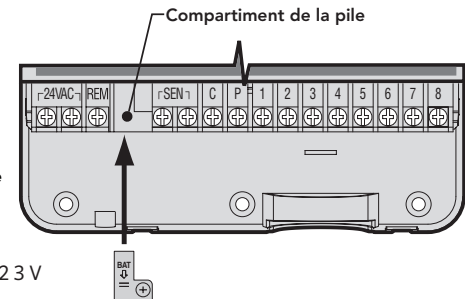
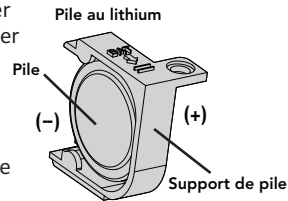

Type de pile : CR2032 3 V



Remarque : Le côté positif (+) de la pile doit faire face à l'intérieur du support de la pile.

BRANCHEMENT D'UNE VANNE MAÎTRESSE



Remarque : Cette partie/phase n'est applicable que si une vanne principale (maîtresse) est installée. Une vanne maîtresse est une vanne "normalement fermée" installée au point d'alimentation principal qui s'ouvre uniquement lorsque le programmeur démarre un programme d'arrosage.

1. Au niveau de la vanne maîtresse, raccorder le câble commun à un des fils du solénoïde de la vanne. Relier le deuxième câble au fil restant du solénoïde.
2. Relier le câble commun à la borne C à l'intérieur du programmeur. L'autre fil provenant de la vanne maîtresse doit être relié à la borne P du programmeur. Serrer chaque borne.

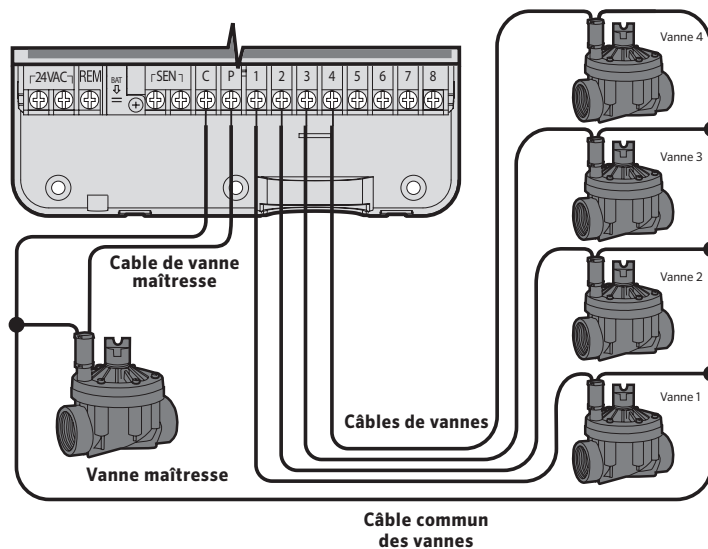

BRANCHEMENT D'UN RELAIS DEMARRAGE DE POMPE



Remarque : Cette section n'est applicable que si un relais démarrage de pompe est installé. Un relais de pompe est un appareil qui commande la mise en route d'une pompe pour alimenter le système en eau.

Le programmeur doit être monté à 4,5 m minimum du relais démarrage de la pompe et de la pompe elle-même pour éviter les interférences électriques.

1. Raccorder les deux câbles du relais démarrage de la pompe jusqu'au programmeur.
2. Raccorder le fil commun à la borne **C** (neutre - généralement un fil blanc) du programmeur et l'autre fil issu du relais de pompe à la borne **P**.

La consommation du relais ne doit pas dépasser 0,30 A. Ne jamais brancher directement le programmeur sur la pompe au risque d'endommager le programmeur.

<http://www.hunterindustries.com/support/controllers/pump-start-relay>

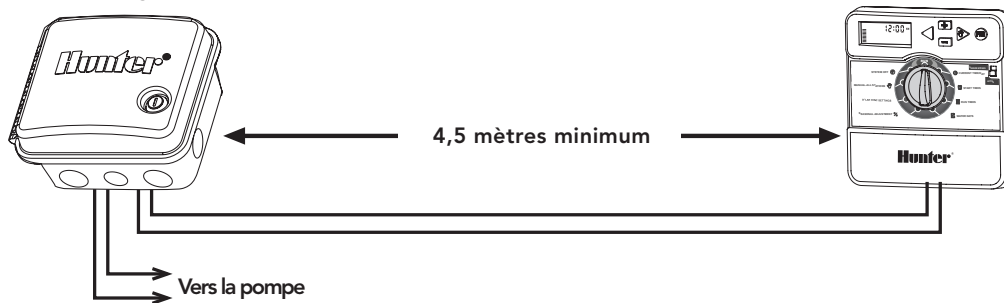

Relais démarrage de pompe



RACCORDEMENT DES SONDES METEOROLOGIQUES

Il est possible de brancher des sondes météorologiques de Hunter sur votre programmateur X-Core, ou tout autre type de capteur à contact sec.

1. Enlever le cavalier fixé sur les deux bornes indiquées SEN.
2. Raccorder un fil de la sonde à la borne indiquée SEN et l'autre fil de la sonde à l'autre borne indiquée SEN.

Lorsqu'une sonde coupe l'arrosage automatique, le mot OFF et les icônes ,  s'affichent sur l'écran.

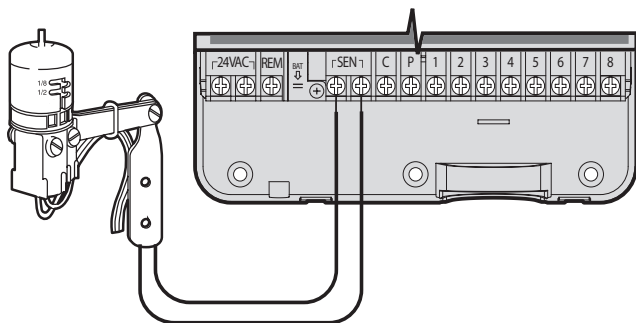

Test des Sondes Météorologiques

Le X-Core effectue un test simplifié de la sonde de pluie lorsqu'elle est raccordée au circuit. Vous pouvez tester manuellement le bon fonctionnement de la sonde de pluie en exécutant un CYCLE AUTO ou en activant le système à l'aide du démarrage automatique d'une seule touche (voir page 22). Lors du cycle manuel, le fait d'appuyer sur la tige au sommet de la sonde Mini-Clik® de Hunter interrompra l'arrosage.



Arrêt manuel des Sondes Météorologiques

Vous pouvez outrepasser les sondes météorologiques en utilisant l'interrupteur Sonde Arrêt sur la façade du programmateur. Mettre l'interrupteur sur la position **SONDE ARRÊT** pour désactiver la sonde météorologique pour permettre l'arrosage. Vous pouvez également passer outre les sondes en utilisant la fonction **Marche Manuelle - Une Station**.



Lorsque vous utilisez la fonction **MARCHE MANUELLE - UNE STATION**, le programmateur ignore automatiquement les informations des sondes pendant la durée sélectionnée. Une fois la durée écoulée, le programmateur rétablira les paramètres sélectionnés.



Remarque: Le fait d'activer le contournement de la sonde n'a aucun effet sur les actualisations du réglage saisonnier envoyées par la sonde Solar Sync. Toutefois, cela permettra de contourner les fonctionnalités Rain Clik et Freeze-Clik de la sonde.

PARAMÈTRES SOLAR SYNC

X-Core est compatible avec les systèmes Solar Sync et Wireless Solar Sync. Solar Sync est un système de capteurs qui règle de façon automatique le calendrier d'arrosage du contrôleur X-Core (en fonction de l'évolution des conditions climatiques locales) au moyen de la fonctionnalité de réglage saisonnier. Le système Solar Sync emploie un capteur solaire et thermique pour mesurer l'évapotranspiration (ET), à savoir le taux auquel les plantes et leurs substrat consomment de l'eau, et inclut également les technologies Hunter Rain Klik et Freeze Klik qui arrêtent l'irrigation lorsqu'il pleut et/ou pendant les périodes de gel.



Remarque : Solar Sync applique une valeur de réglage saisonnier de 100 % par défaut jusqu'à ce que le premier jour complet (une période de 24 heures) de mesures météo ait été transmis par le capteur.



Remarque : L'actionnement du bouton d'arrêt est sans effet sur les mises à jour de réglage saisonnier provenant du capteur Solar Sync. Il permet, cependant, de contourner les fonctionnalités Rain Klik et Freeze Klik du capteur.



Remarque : le module Solar Sync n'est pas nécessaire pour l'installation du programmeur X-Core.

Installation du capteur Solar Sync

Connectez le fil vert et noir du capteur Solar Sync sur les bornes de câblage **SEN** du contrôleur X-Core. Peu importe la borne de connexion des fils. Placez la mollette sur la position

Solar Sync Paramètres. L'afficheur présente initialement des lignes en pointillé, puis affiche le paramètre régional par défaut (3) sur la gauche et le paramètre d'ajustement de l'eau (5) sur la droite.



Installation du récepteur Wireless Solar Sync



Connectez le fil vert et noir du récepteur Wireless Solar Sync sur les bornes de câblage **SEN** du contrôleur X-Core. Peu importe la borne de connexion des fils. Placez la mollette sur la position **Solar Sync Paramètres.**

L'afficheur présente initialement des lignes en pointillé, puis affiche le paramètre régional par défaut (3) sur la gauche et le paramètre d'ajustement de l'eau (5) sur la droite.



Paramètres Solar Sync

Lorsque le capteur Solar Sync est connecté au contrôleur X-Core, deux chiffres s'affichent. Vous pouvez alors programmer les paramètres Solar Sync. Le numéro situé à droite de l'écran correspond au paramètre régional, tandis que le numéro de gauche correspond aux paramètres de réglage de l'eau.

Pour bénéficier de mesures Solar Sync précises, le contrôleur doit être programmé en fonction de la valeur ET type (valeur ET moyenne de la haute saison) de votre région. Utilisez le tableau de la page suivante pour identifier votre région. Utilisez la touche  ou  pour sélectionner votre région (1-4).

PROGRAMMATION DU MODULE SOLAR SYNC

Region

Pour bénéficier de mesures Solar Sync précises, le programmeur doit être programmé en fonction de la valeur ET moyenne de la haute saison de votre région. Utilisez le tableau ci-dessous pour identifier votre région.

Ce tableau vous permettra d'identifier votre type de région. Il existe quatre régions ET de base, chacune avec des descriptions de la région, ainsi que les caractéristiques d'ET et de températures types. Il est recommandé, si possible, de choisir la région en fonction de l'ET moyen en juillet ou de l'ET d'été de pointe (mm/pouces par jour).

Utilisez le tableau suivant pour sélectionner votre région (référence ci-dessous). Vous pouvez utiliser la ligne A, B ou C pour vous aider à choisir la région convenant le mieux à votre secteur :



- En fonction de l'ET de votre région à l'aide de l'ET moyen en juillet ou de l'ET d'été de pointe (pouces/mm par jour). Il s'agit de la meilleure option pour sélectionner votre région.
- En fonction de la température de votre région à l'aide du mois de juillet moyen ou de la température maximale du mois le plus sec (pas la température maximale pour juillet).
- En fonction de la description générale de votre région.

SI L'UNE DES OPTIONS DANS LES LIGNES S'APPLIQUE À VOTRE SITUATION, IL S'AGIT DE VOTRE CHOIX DE RÉGION.			
	A	B	C
Régions 1	Si l'ET moyenne en juillet est < 4,3 mm (0,17") par jour	Si la température élevée moyen ne pour juillet est comprise entre 18 et 24°C (65 et 75° F)	<ul style="list-style-type: none"> • Etats américains septentrionaux • Régions côtières
Régions 2	Si l'ET moyenne en juillet est comprise entre 4,6 et 5,8 mm (0,18 et 0,23") par jour	Si la température élevée moyen ne pour juillet est comprise entre 24 et 29°C (75 et 85° F)	<ul style="list-style-type: none"> • Montagnes • Etats américains intérieurs septentrionaux
Régions 3	Si l'ET moyen en juillet est compris entre 6,1 et 7,4 mm (0,24 et 0,29") par jour	Si la température élevée moyen ne pour juillet est comprise entre 29 et 35°C (85 et 95° F)	<ul style="list-style-type: none"> • Etats américains méridionaux • Désert intérieur/grand désert
Régions 4	Si l'ET moyenne en juillet est > 7,6 mm (0,30") par jour	Si la température élevée moyen ne pour juillet est comprise entre 35 et 41°C (95 et 105° F)	<ul style="list-style-type: none"> • Déserts

* Pour les régions de l'hémisphère sud, utiliser le mois de janvier.

PROGRAMMATION DU MODULE SOLAR SYNC



Ajustement de l'arrosage ↑↓

Si vous estimez que votre jardin est « plus humide » ou « plus sec » que la normale, une fonction d'ajustement de l'arrosage permet d'ajuster ce dernier dans toutes les stations. Utilisez le bouton → jusqu'à ce que la flèche indique l'icône ↑↓. Utilisez le bouton  ou  pour augmenter ou diminuer l'arrosage sur une échelle de 1 à 10 (1 pour moins d'eau et 10 pour plus d'eau). Hunter recommande d'observer attentivement les performances durant les premières semaines de fonctionnement avant d'ajuster l'arrosage.



Remarque : si une zone individuelle est « plus humide » ou « plus sèche » que le reste du système, augmentez ou diminuez simplement la durée de fonctionnement sur le programmeur.

Désinstallation d'un capteur Solar Sync

Si un capteur Solar Sync a été installé sur le contrôleur X-Core, la valeur de réglage saisonnier employée par le contrôleur sera calculée à partir des données météorologiques fournies par le capteur Solar Sync. **Si le capteur Solar Sync ne doit plus être utilisé avec le contrôleur X-Core, il doit être désinstallé. Si le capteur Solar Sync n'est pas désinstallé, le contrôleur n'autorisera pas la modification manuelle de la valeur de réglage saisonnier.** Par exemple, si la valeur de réglage saisonnier du contrôleur est de 50 % lorsque le capteur Solar Sync est retiré, elle reste de 50 % jusqu'à ce que le capteur Solar Sync soit désinstallé. Pour désinstaller le capteur Solar Sync, déconnectez simplement les fils vert et noir de la borne du contrôleur, puis placez la molette en position SOLAR SYNC Paramètres. L'écran doit alors comporter des tirets, ce qui indique que le contrôleur ne reconnaît plus le capteur Solar Sync pour le calcul du réglage saisonnier. La valeur de réglage saisonnier peut alors être modifiée de façon manuelle en plaçant la molette sur la position Réglage Saisonnier et en utilisant la touche  ou  pour régler cette valeur.

PROGRAMMATION DU MODULE SOLAR SYNC

Période de configuration/étalonnage

Une fois le système Solar Sync installé et programmé, il est recommandé de le laisser fonctionner quelques jours avec la configuration initiale. En raison des nombreuses conditions du site (y compris l'emplacement du capteur, la quantité de lumière directe du soleil dont il bénéficie, la chaleur réfléchie par les structures environnantes, etc.), **la configuration initiale peut nécessiter un réglage pour atteindre les performances désirées**. L'étalonnage du système Solar Sync pour un site particulier peut facilement être réalisé en réglant les paramètres de région et/ou d'ajustement de l'arrosage. Les instructions ci-dessous décrivent brièvement cette procédure.

1. Installez le capteur Solar Sync et programmez le module (conformément aux instructions des pages 16).
2. Laissez le système fonctionner avec la configuration initiale pendant au moins 3 jours.
3. Observez le réglage saisonnier sur le programmeur. S'il est inférieur ou supérieur au réglage habituel pour cette période de l'année, les paramètres du système Solar Sync doivent être ajustés.
 - a. **Réglage saisonnier trop bas**: Augmentez la valeur de l'échelle d'ajustement de l'arrosage (le réglage par défaut est 5). Une fois le paramètre modifié, le programmeur est immédiatement mis à jour avec le nouveau pourcentage de réglage saisonnier. Augmentez le paramètre d'ajustement de l'arrosage jusqu'à l'affichage du pourcentage de réglage saisonnier désiré. **Si vous augmentez l'échelle d'ajustement de l'arrosage à 10 (maximum) et que vous avez besoin d'accroître encore le réglage saisonnier, sélectionnez la région inférieure (passez de la région 4 à la région 3, par exemple).**
 - b. **Réglage saisonnier trop élevé**: Diminuez la valeur de l'échelle d'ajustement de l'arrosage (le réglage par défaut est 5). Une fois le paramètre modifié, le programmeur est immédiatement mis à jour avec le nouveau pourcentage de réglage saisonnier. Diminuez le paramètre d'ajustement de l'arrosage jusqu'à l'affichage du pourcentage de réglage saisonnier désiré. **Si vous réduisez l'échelle d'ajustement de l'arrosage à 1 (minimum) et que vous avez besoin de diminuer encore le réglage saisonnier, sélectionnez la région supérieure (passez de la région 2 à la région 3, par exemple).**

Temps de fonctionnement des stations: Il importe de comprendre que le système Solar Sync offre un réglage saisonnier global au programmeur. En d'autres termes, tous les temps de fonctionnement des stations seront modifiés en fonction du pourcentage de réglage saisonnier indiqué. Lors de la programmation du programmeur, les temps de fonctionnement saisis doivent représenter le programme d'arrosage de la période de pointe. Si le système Solar Sync est paramétré sur la valeur de réglage saisonnier appropriée, mais que le temps de fonctionnement d'une station particulière est trop long ou trop court, réglez le temps de fonctionnement des stations dans le programme du programmeur.

FONCTIONNALITÉ DE DÉLAI SOLAR SYNC

Fonctionnalité de délai Solar Sync pour X-CORE®

La fonctionnalité de délai n'est accessible qu'après l'installation de Solar Sync. La fonctionnalité de délai Solar Sync vous permet de différer jusqu'à 99 jours des changements de réglage saisonnier effectués par la sonde Solar Sync.

Lorsque le délai Solar Sync est en mode actif, Solar Sync continue de collecter et d'enregistrer les données.

Fonctionnement :

Pour accéder au paramètre de délai Solar Sync :

1. Positionnez le sélecteur sur **MARCHE**, maintenez enfoncé le bouton **+**, tournez le sélecteur jusqu'à la position Solar Sync, puis relâchez le bouton **+**. L'écran affiche : **d:XX** (où **d** indique les jours et **XX** le nombre de jours différés).
2. Appuyez sur le bouton **+** ou **-** pour augmenter/diminuer le nombre de jours du délai. Une fois que le nombre de jours voulu s'affiche, repositionnez le sélecteur sur **MARCHE** pour activer le délai.



Remarque: Le nombre de jours restants ne s'affiche pas sur l'écran **MARCHE**. Pour vérifier que la fonctionnalité de délai est active, ouvrez le menu du délai Solar Sync et vérifiez que les jours sont affichés. Si un ou plusieurs jours s'affichent, le délai Solar Sync est actif ; si 00 s'affiche, alors le délai Solar Sync n'est pas actif.

Pour modifier le paramètre actuel des jours de délai :

1. Ouvrez le menu du délai Solar Sync en appuyant sur le bouton **+** et en tournant le sélecteur jusqu'à Paramètres Solar Sync, puis relâchez le bouton **+**.
2. Utilisez la touche **+** ou **-** pour modifier le nombre de jours jusqu'à ce que s'affiche le nombre voulu de jours pour le délai. (Le fait de paramétrer les jours sur 00 désactive le délai Solar Sync.)
3. Repositionnez le sélecteur sur **MARCHE** pour que les changements prennent effet.

Tant que le délai Solar Sync sera actif, la sonde Solar Sync continuera de collecter des informations météorologiques et de calculer la valeur du réglage saisonnier. Le réglage saisonnier mis à jour s'appliquera une fois que les jours du délai Solar Sync auront atteint 00.

CONNEXION À UNE TÉLÉCOMMANDE HUNTER

Connexion à une télécommande Hunter (non incluse)

Le programmeur X-Core est désormais compatible avec les télécommandes Hunter (non incluses). Le faisceau de câblage SmartPort (inclus avec toutes les télécommandes Hunter) permet d'actionner rapidement et facilement tous les contrôles Hunter. Les télécommandes Hunter permettent d'utiliser le système sans avoir à faire l'aller-retour jusqu'au programmeur.

Pour installer le connecteur SmartPort

1. Installez un "té" à filetage femelle de 1/2" dans le conduit de câblage (non inclus) environ 12 pouces sous le X-Core.
2. Passez les câbles rouge, blanc et bleu du câblage par la base du té et dans le compartiment de câblage, comme illustré.

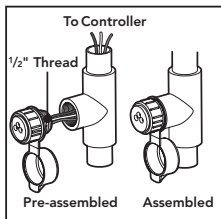

Remarque : PN 258200 peut être utilisé en remplacement du connecteur SmartPort.

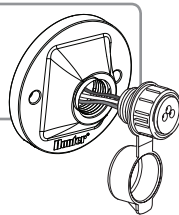

3. Vissez le bâti du faisceau SmartPort sur le té comme indiqué.
4. Connectez les câbles SmartPort rouge, blanc et bleu sur les bornes du programmeur comme indiqué ci-dessous :
 - Câble rouge sur le côté gauche de la borne « 24 V c.a. »
 - Câble blanc sur le côté droit de la borne « 24 V c.a. »
 - Câble bleu sur la borne « REM »

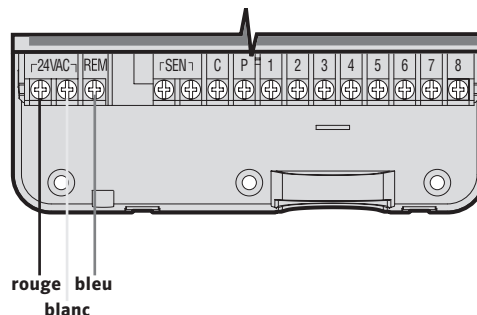

COUPURES DE COURANT



Compte tenu des risques de coupure de courant, le programmeur possède une mémoire non volatile. Les informations programmées ne sont jamais perdues. En l'absence d'alimentation, le programmeur conserve le jour et l'heure pendant un mois. Les programmes normaux reprennent dès que l'alimentation est rétablie.

LA PROGRAMMATION

Lorsque le programmeur n'est pas en fonctionnement, l'affichage du programmeur X-Core indique l'heure et le jour. L'affichage se modifie en tournant le sélecteur central pour accéder à une fonction précise de programmation. Lors de la programmation, utiliser les touches **+** ou **-** pour modifier l'affichage clignotant. Pour modifier les informations qui ne clignotent pas, appuyer sur les touches **◀** ou **▶** jusqu'à ce que le champ souhaité clignote.

Pour chacun des trois programmes A, B et C on peut créer 4 départs d'arrosage par jour. Ceci permet de répondre à tous les besoins d'arrosage différents.

Réglage du jour et de l'heure ⌚

1. Tourner le sélecteur sur la position **RÉGLAGE HEURE/JOUR**.
2. L'année clignote. Appuyer sur les touches **+** ou **-** pour modifier et enregistrer l'année courante. Appuyer ensuite sur la touche **▶** pour le réglage du mois.
3. Le mois et le jour s'affichent. Le mois clignote et l'icône  est affichée. Utiliser les touches **+** ou **-** pour modifier et enregistrer le mois courant. Appuyer sur la touche **▶** pour régler le jour.
4. Le jour clignote et l'icône  est affichée. Utiliser les touches **+** ou **-** pour modifier et enregistrer le jour courant. Appuyer sur la touche **▶** pour régler l'heure.
5. L'heure est affichée. Utiliser les touches **+** et **-** pour choisir le mode 24H. Appuyer sur la touche **▶** pour régler l'heure. L'heure clignote. Utiliser les touches **+** ou **-** pour modifier et enregistrer l'heure affichée. Appuyer sur la touche **▶** pour passer au réglage des minutes. Les minutes clignotent. Utiliser les touches **+** ou **-** pour régler les minutes. Maintenant la date, le jour et l'heure sont réglés.





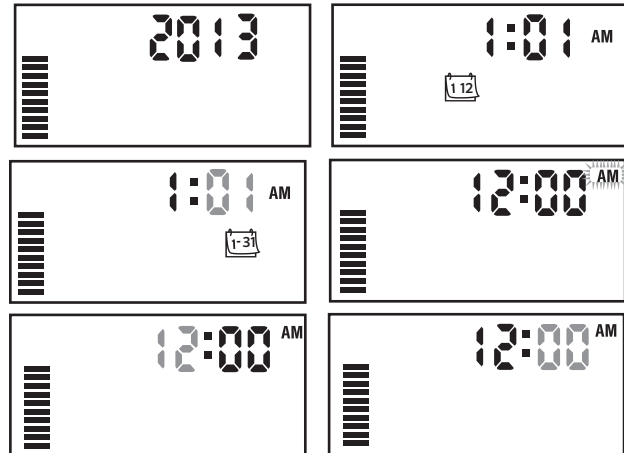

Remarque : Pendant la programmation le symbole ou icône clignotant est l'élément à programmer. Par exemple, si l'heure clignote lorsque vous réglez le jour et l'heure, vous pouvez modifier ou programmer l'heure. Dans cette notice, les symboles clignotants apparaissent en GRIS.



LA PROGRAMMATION



Réglage des départs de cycle

1. Tourner le bouton sur la position **RÉGLAGE DÉPARTS CYCLE**.
2. Le programme A est le premier accessible. Vous pouvez également sélectionner le programme B ou C en appuyant sur la touche .
3. Modifier les heures de départs de cycle par incréments de 15 minutes en utilisant les touches  ou .
4. Pour ajouter un autre départ dans le même programme, utiliser la touche  ou appuyer sur la touche  pour passer au programme suivant.





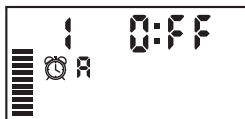

Remarque : Un seul départ déclenchera séquentiellement l'arrosage de toutes les stations affectées à ce programme. Cette fonction automatique évite d'avoir à programmer l'heure de départ de chaque station. Des départs de cycles multiples d'un programme peuvent être utilisés pour des cycles d'arrosage distincts le matin, l'après-midi ou le soir. Les départs de cycles peuvent être programmés dans n'importe quel ordre. Le programmeur X-Core les classera automatiquement.

Suppression d'un départ de cycle programmé

Mettre le sélecteur sur la position **RÉGLAGES DÉPARTS CYCLE**, et appuyer sur les touches  ou  jusqu'à l'heure 12:00 s'affiche. Ensuite, appuyer une fois sur la touche  pour que le mot **Arrêt** s'affiche. Appuyez sur la flèche droite pour supprimer une deuxième heure de démarrage.





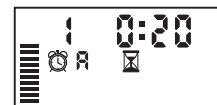

Réglage des temps d'arrosage

1. Mettre le sélecteur sur la position **RÉGLAGE TEMPS D'ARROSAGE**.
2. L'écran indique le dernier programme sélectionné (A, B ou C), le numéro de la station sélectionnée, l'icône du temps d'arrosage . La station correspondante clignote. Utiliser la touche  pour passer à un autre programme.
3. Utiliser les touches  ou  pour modifier le temps d'arrosage de la station affichée à l'écran. Vous pouvez régler le temps d'arrosage de 1 minute à 4 heures.
4. Appuyer sur la touche  pour passer à la station suivante.







Réglage des jours d'arrosage

1. Mettre le sélecteur sur la position **RÉGLAGE JOURS D'ARROSAGE**.
2. L'écran indique le dernier programme sélectionné (A, B ou C). Vous pouvez passer à un autre programme en appuyant sur la touche .
3. Le programmeur affiche les sept jours de la semaine en anglais : MO, TU, WE, TH, FR, SA, SU (**MO = lundi, TU = mardi, WE = mercredi, TH = jeudi, FR = vendredi, SA = samedi, SU = dimanche**) avec une icône  ou  au dessus du jour de la semaine. L'icône  représentera un jour avec arrosage et l'icône  un jour sans arrosage.



LA PROGRAMMATION



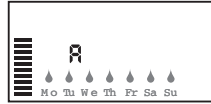

Sélection des jours spécifiques de la semaine pour arroser

- Le symbole  étant placé sur un jour spécifique (le curseur démarre toujours à MO), appuyer sur la touche  pour activer un jour particulier de la semaine. Appuyer sur la touche  pour annuler l'arrosage ce jour-là. Après pression sur une touche, le curseur passe automatiquement au jour suivant.
- Répéter l'étape 1 jusqu'à ce que tous les jours de votre choix aient été sélectionnés. Les jours sélectionnés sont indiqués par l'icône . La dernière icône  correspond au dernier jour d'arrosage du programme.



Sélection des jours pairs ou impairs pour arroser

Cette fonction permet l'arrosage certains jours de la semaine (par ex., jours impairs : 1^{er}, 3^{ème}, 5^{ème}, etc. Ou jours pairs : 2^{ème}, 4^{ème}, 6^{ème}, etc.).



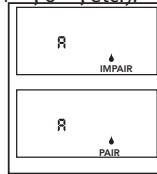

- Appuyez sur la flèche droite  jusqu'à ce que le curseur soit sur SU (dimanche).
- Appuyez encore une fois sur la flèche droite pour qu'apparaisse impair avec l'icône en forme de goutte de pluie. Si vous voulez arroser les jours impairs, repositionnez le sélecteur sur Marche.
- Si vous souhaitez arroser les jours pairs, appuyez une fois sur le bouton . L'icône  et **PAIR** s'affichent. Vous pouvez basculer entre **IMPAIR** et **PAIR** en appuyant sur les boutons .
- Remettre le sélecteur sur la position Marche.



Remarque : L'arrosage sera suspendu tous les 31 du mois et le 29 Février si l'arrosage par jour impair est programmé.

Sélection des intervalles entre arrosages

Avec cette option, vous pouvez sélectionner un intervalle entre arrosages de 1 à 31 jours.

- Le curseur étant placé sur le mot **PAIR**, appuyer une fois sur la touche . L'icône  apparaît et le chiffre 1 clignote à l'écran. L'intervalle entre arrosages apparaît alors à l'écran.
- Utiliser les touches  ou  pour régler le nombre de jours séparant chaque jour d'arrosage (de 1 à 31). Ceci est l'intervalle entre arrosage.



Le programmeur lancera l'arrosage selon le programme sélectionné au prochain départ de cycle et l'arrosage se fera suivant l'intervalle programmé.



Remarque : Pour quitter le mode Intervalle (si vous ne le voulez pas), appuyez sur la flèche gauche jusqu'à ce que s'affiche à nouveau l'écran des jours de la semaine.

Réglage des jours sans arrosage

X-Core vous permet de programmer un ou plusieurs jours sans arrosage. Cette fonction est utile pour désactiver l'arrosage un jour spécifique. Par exemple, si vous tondez toujours la pelouse le samedi, vous désignerez samedi comme **Jour sans arrosage** afin que la pelouse ne soit pas mouillée ce jour là.

- Mettre le sélecteur sur la position **RÉGLAGE JOURS D'ARROSAGE**.
- Entrer un intervalle d'arrosage en suivant les instructions de la page 20.
- Appuyer sur la touche  pour trouver les mots **JOURS SANS ARROSAGE**. Le mot MO (pour lundi) clignote.

LA PROGRAMMATION

- Utiliser la touche ► pour avancer le curseur sur le jour de la semaine que vous souhaitez régler comme **JOUR SANS ARROSAGE**.
- Appuyer sur la touche ■ pour enregistrer ce jour comme un jour sans arrosage. L'icône ☹ s'allume au dessus de ce jour.
- Répéter les étapes 4 et 5 pour enregistrer d'autres jours sans arrosage.



Remarque : Vous pouvez également programmer des jours pairs ou impairs sans arrosage avec la fonction intervalle d'arrosage.

Arrosage automatique

Après avoir programmé le X-Core, remettre le sélecteur en position **MARCHE** pour autoriser le fonctionnement automatique.

Arrêt du système

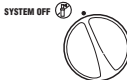
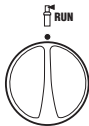

Mettre le sélecteur sur **ARRÊT**. Toutes les vannes ouvertes se ferment dans un délai de deux secondes. Tous les programmes sont suspendus et l'arrosage arrêté. Pour remettre le programmeur en mode automatique, il suffit de tourner le sélecteur sur la position **MARCHE**.



Suspension de l'arrosage

Cette fonction permet à l'utilisateur de suspendre tous les programmes d'arrosage pour une période déterminée de 1 à 7 jours. A la fin de la période de suspension d'arrosage, le programmeur reprend le cycle d'opération automatique normal.

- Tourner le sélecteur sur la position ARRÊT. L'écran indique le mot OFF (Arrêt).

- Appuyer sur ■ pour choisir le nombre de jours de la suspension de l'arrosage (de 1 à 7).
- Remettre le sélecteur sur la position MARCHE. Le mot OFF (Arrêt), un chiffre et les icônes  et  s'affichent.



Les jours restants sans arrosage vont diminuer chaque soir à minuit. Quand le système arrive à zéro, l'affichage indique l'heure courante et l'arrosage normal recommence comme prévu.



Réglage saisonnier %

Le réglage saisonnier est utilisé pour modifier globalement les temps d'arrosage sans reprogrammer. Pour utiliser cette fonction :

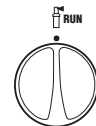

- Mettre le sélecteur sur la position RÉGLAGE SAISONNIER.
- Un chiffre clignote suivi d'un pourcentage (%) et une échelle de barres visibles en permanence. Utiliser les touches ■ et ■ pour régler le pourcentage souhaité de réglage saisonnier. Chaque barre sur le graphique représente 10%. Cette fonction permet de régler les durées d'arrosage globalement de 10% à 150% de la valeur pré-programmée.



Pour visualiser les nouveaux temps d'arrosage, tourner le sélecteur sur **RÉGLAGE TEMPS D'ARROSAGE**.

Les nouveaux temps d'arrosage correspondants au réglage saisonnier s'affichent.



LA PROGRAMMATION



Remarque : La programmation initiale doit toujours s'effectuer dans la position 100%.

Lorsque vous utilisez un capteur météo « Clic » de Hunter, la valeur de réglage saisonnier peut être définie comme indiqué ci-dessus.

Si vous utilisez un capteur Solar Sync ET, la valeur de réglage saisonnier est mise à jour quotidiennement de façon automatique selon les informations météorologiques transmises par le capteur Solar Sync. Cette valeur peut être modifiée manuellement en appuyant sur la touche **+** ou **-**. **Cependant, il est important de comprendre que la valeur d'ajustement manuel saisonnier sera remplacée à minuit par la nouvelle valeur mise à jour par le capteur Solar Sync.**

Le capteur Solar Sync ET suit l'évolution du temps, détermine la valeur de réglage saisonnier optimale et met à jour le contrôleur de façon quotidienne.

Lancement manuel d'une seule station

1. Mettre le sélecteur sur la position **MARCHE MANUELLE - UNE STATION**.
2. La durée d'arrosage de la station clignote. Utiliser la touche **▶** pour choisir la station désirée. Pour sélectionner la durée d'arrosage d'une station, utiliser les touches **+** et **-**.
3. Mettre le sélecteur sur la position **MARCHE**, en tournant dans le sens des aiguilles d'une montre. Seule la station désignée arrose. Le programmeur repasse ensuite en mode automatique sans que le programme préalablement sélectionné ne soit modifié.

MANUAL-ONE STATION 



Touche unique démarrage manuel





Vous pouvez également activer toutes les stations d'arrosage sans utiliser le sélecteur.

1. Maintenir la touche **▶** enfoncée pendant 2 secondes.
2. Cette fonction passe automatiquement sur le programme A. Vous pouvez sélectionner le programme B ou C en appuyant sur la touche **PRG**.
3. Le numéro de la station clignote. Appuyer sur la touche **▶** pour faire défiler les stations. Utiliser les touches **+** et **-** pour régler la durée d'arrosage de chaque station. Si vous n'utilisez pas les touches pendant quelques secondes pendant les étapes 2 ou 3, le programmeur démarre l'arrosage automatiquement.
4. Appuyer sur la touche **▶** pour choisir la station par laquelle vous souhaitez commencer. Au bout de 2 secondes, le programme démarre. Vous pouvez utiliser à tout moment durant le cycle manuel les touches **◀** ou **▶** pour naviguer manuellement d'une station à l'autre.

FONCTIONS AVANCÉES

Désactivation d'une sonde météorologique programmable

Le programmeur X-Core permet à l'utilisateur de paramétrer le programmeur de sorte que la sonde ne désactive l'arrosage que sur les stations désirées. Par exemple, les jardins intérieurs peuvent être couverts et nécessiter un arrosage même en cas de pluie. Pour programmer l'annulation de la sonde :



1. Mettre le sélecteur sur la position **MARCHE**.
2. Maintenir appuyée la touche  enfoncée tout en tournant le sélecteur sur RÉGLAGE DÉPART CYCLES.
3. Relâcher la touche . L'écran affiche le numéro de station, le mot ON (Activé) et l'icône  clignote.
4. Appuyer sur les touches  ou  pour activer ou désactiver la sonde pour la station affichée.



Le mot affiché ON signifie que la sonde est activée et que l'arrosage sera interrompu en cas de nécessité.

Le mot affiché OFF signifie que la sonde est désactivée pour la station sélectionnée et que l'arrosage sera autorisé, même en cas d'intempérie.



5. Utiliser les touches  ou  pour passer à la station suivante et programmer une autre annulation par sonde.





Remarque: Par défaut, le programmeur désactive l'arrosage pour toutes les stations en cas de pluie.

Lorsque le programmeur X-Core reçoit un signal de la sonde pour désactiver l'arrosage, l'écran indique les stations qui ont été programmées pour passer outre la sonde. Une station qui

fonctionne en mode annulation de la sonde affiche les icônes  et  qui clignotent alternativement.

Programme test de toutes les stations





Le programmeur X-Core offre à l'utilisateur une méthode simplifiée pour lancer un programme test. Cette fonction fait fonctionner chaque station dans l'ordre numérique croissant.

1. Avec le sélecteur en position **MARCHE**, maintenez enfoncé le bouton . Le numéro de la station s'affiche et le temps clignote pendant deux secondes.
2. Utiliser les touches  ou  pour régler la durée de fonctionnement de 1 à 15 minutes. Ce réglage n'a besoin d'être saisi qu'une seule fois.
3. Après une pause de 2 secondes, le programme test démarre.

Diagnostic Quick Check de Hunter

Cette fonction permet de diagnostiquer rapidement les problèmes électriques éventuels de votre installation. Au lieu de vérifier chaque circuit de câblage sur le terrain, vous pouvez utiliser cette procédure de vérification de circuit Quick Check.

Pour lancer ce test :

1. Appuyer simultanément sur les touches , , , et . En mode veille, l'écran affiche tous ces éléments.
2. Appuyer une fois sur la touche  pour commencer la procédure Quick Check. Après quelques secondes, le programmeur vérifie toutes les stations pour des éventuels problèmes électriques. Lorsqu'un court-circuit est détecté, le symbole ERR, précédé du numéro de la station concernée, clignote momentanément sur l'écran. Lorsque la procédure Quick Check a terminé de tester tous les circuits, le programmeur reprend le mode d'arrosage automatique normal.

FONCTIONS AVANCÉES

Mémoire de programme Easy Retrieve™ (facile à récupérer)

Le programmeur X-Core peut sauvegarder votre programme d'arrosage d'origine d'installation dans la mémoire interne afin de le récupérer plus tard. Cette fonction réinitialise le X-Core au programme d'arrosage initial.

Pour sauvegarder le programme dans la mémoire.

1. Avec le sélecteur en position MARCHE, appuyer et maintenir les touches **+** et **PRG** enfoncées pendant 5 secondes. Trois traits se déplacent de la gauche vers la droite de l'écran pour indiquer que la sauvegarde du programme est en cours.
2. Relâcher les touches **+** et **PRG**.

Pour récupérer un programme préalablement sauvegardé en mémoire.

1. Avec le sélecteur en position MARCHE, appuyer et maintenir les touches **-** et **PRG** enfoncées pendant 5 secondes. Trois traits se déplacent de la gauche vers la droite de l'écran pour indiquer que la sauvegarde du programme est en cours.
2. Relâcher les touches **-** et **PRG**.

Délai programmable entre stations

Cette fonction permet d'insérer un délai entre l'arrêt d'une station et le démarrage de la suivante.

1. Commencer avec le sélecteur sur la position MARCHE.
2. Appuyer et maintenir la touche **+** enfoncée tout en tournant le sélecteur sur la position RÉGLAGE TEMPS D'ARROSAGE.
3. Relâcher la touche **+**. L'affichage fait clignoter un délai, en secondes, pour toutes les stations.
4. Appuyez sur le bouton **+** ou **-** pour augmenter ou réduire le délai entre 0 secondes et 4 heures.
5. Remettre le sélecteur sur la position MARCHE.

Effacer la mémoire du programmeur/ Remise à zéro du programmeur

Si vous voulez complètement réinitialiser la mémoire du programmeur X-Core, effacer tous les programmes et informations que vous avez enregistrés :

1. Maintenez enfoncé le bouton **PRG**.
2. Tout en maintenant enfoncé le bouton **PRG**, appuyez sur le bouton situé sur la droite du programmeur et relâchez-le.
3. Gardez enfoncé le bouton **PRG** jusqu'à ce que l'heure 12:00 am s'affiche (cela prend environ 8 secondes).

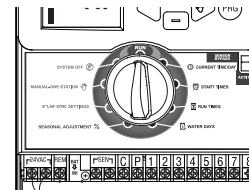

Réinitialisation

INSTRUCTIONS POUR LE DÉLAI CLIK

Fonctionnalité de délai Klik

Cette fonctionnalité permet à l'utilisateur de différer des arrosages programmés pendant une durée donnée (entre 1 et 7 jours) APRÈS la fin d'un événement Klik. À la fin du délai Klik programmé, le programmeur reprend un arrosage automatique normal.

1. Positionnez le sélecteur sur **MARCHE**
2. Maintenez enfoncé le bouton **+** pendant 3 secondes, puis positionnez le sélecteur sur **ARRÊT**
3. Relâchez le bouton **+**. L'écran affiche le délai Klik programmable.



4. Appuyez sur le bouton **+** pour paramétrer la durée du délai Klik (entre 1 et 7 jours).
5. Repositionnez le sélecteur sur **MARCHE**. Le délai Klik est paramétré.

Après la fin d'un événement Klik (la sonde de pluie passe d'humide à sèche), la fonctionnalité de délai Klik s'active et l'écran affiche la durée du délai Klik. Le compte à rebours des jours commence 24 heures après le début du délai Klik.



Il est possible d'annuler un délai Klik actif en positionnant le sélecteur sur **ARRÊT**, en attendant que ARRÊT arrête de clignoter, puis en repositionnant le sélecteur sur **MARCHE**.

Toutes les stations programmées pour contourner la sonde, ainsi que les programmes d'éclairage, fonctionneront pendant un événement de délai Klik.



Remarque: Faites attention lorsque vous utilisez la fonctionnalité de délai Klik programmable avec les sondes Wind-Klik®, Freeze-Klik®, Soil-Klik de Hunter et les composants de gel des Solar Sync et Rain/Freeze Klik, car le délai Klik s'active APRÈS l'événement Klik détecté par ces appareils.

FONCTIONS CACHÉES

Personnalisation de programme

Le X-Core est configuré par défaut avec 3 programmes indépendants (**A, B, C**) qui disposent de quatre heures de départ chacun pour répondre aux besoins des différents types de plantes. Le X-Core peut être personnalisé de manière à n'afficher qu'un programme et une heure de départ, masquant les programmes et heures de départ supplémentaires dont vous n'avez pas besoin, ce afin de simplifier la programmation.

1. Commencez avec le sélecteur en position **MARCHE**.
2. Maintenez enfoncé le bouton - . Tournez le sélecteur jusqu'à la position **JOURS D'ARROSAGE**
3. Relâchez le bouton - .
4. Utilisez les boutons + et - pour changer de mode de programmation.

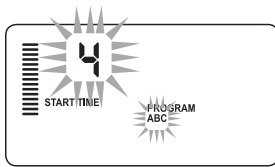

Mode normal (3 programmes /
4 heures de départ)

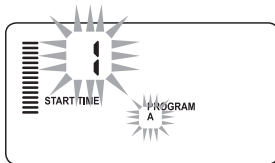

Mode limité (1 programme /
1 heure de départ)

FONCTIONNALITÉS CACHÉES (SUITE)

Arrosage et réessuyage

La fonction d'arrosage et de réessuyage permet de diviser le temps d'arrosage d'une station en temps d'arrosage plus courts et plus pratiques. Cette fonction est utile lors de l'arrosage de sols pentus et imperméables, car l'eau est automatiquement distribuée plus lentement pour empêcher tout ruissellement. Entrez la durée d'arrosage en tant que fraction du temps d'arrosage de la station et la durée de ré-essuyage, en tant que nombre minimum de minutes requises avant le prochain arrosage. Pour déterminer le nombre total de cycles, divisez la durée d'arrosage totale programmée de la station par la durée du cycle.

Accéder au menu Arrosage et réessuyage:

Pour accéder à la fonctionnalité d'arrosage et réessuyage, positionnez le sélecteur sur **MARCHE** et maintenez enfoncé le bouton **+** pendant 3 secondes. Tout en maintenant enfoncé le bouton **+**, positionnez le sélecteur sur **RÉGLAGE TEMPS D'ARROSAGE**, puis relâchez le bouton.

Réglage de la durée d'arrosage :

La station 1 s'affiche en premier. Pour accéder à d'autres stations, appuyez sur le bouton **◀** ou **▶**.

Une fois que la station voulue s'affiche, utilisez le bouton **+** ou **-** pour augmenter ou diminuer la durée du cycle. L'utilisateur peut régler la durée entre 1 minute et 4 heures par incréments d'une minute, ou choisir **OFF** (arrêt) s'il ne souhaite pas de cycle.



Remarque : Seules les minutes sont affichées pour moins d'une heure (par exemple : 36). Au-delà d'une heure, l'écran change et inclut les heures (par exemple : 1:13 et 4:00). Si le temps d'arrosage d'une station est égal ou inférieur au temps de cycle, aucun cycle ne s'applique.

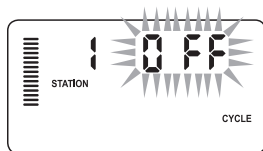

Exemple d'écran de cycle à la saisie

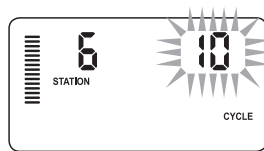

Exemple d'écran de cycle avec seulement les minutes

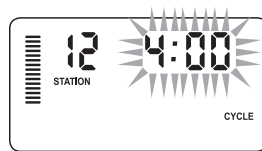

Exemple d'écran de réessuyage comprenant les heures

FONCTIONNALITÉS CACHÉES (SUITE)

Accès au menu Réessuyage :

Une fois que vous avez programmé les durées de cycle souhaitées pour chaque station, la durée du cycle devient accessible en appuyant sur le bouton **PRG**.

La station reste la même que celle précédemment affichée sous la durée du cycle (c'est-à-dire que si la station 2 s'affiche dans le menu Cycle, la station 2 s'affichera lorsque vous appuierez sur le bouton **PRG**).



Remarque: Le menu Réessuyage n'est pas accessible si aucune durée de cycle n'est programmée.

Réglage de la durée de réessuyage :

Pour accéder à d'autres stations, appuyez sur les boutons ◀ ou ▶.



Remarque: Lors du changement de station, l'écran revient au temps d'arrosage si une station n'a pas de temps d'arrosage. Passez à la station suivante possédant une durée de cycle et appuyez sur le bouton **PRG** pour revenir en arrière.

Une fois que la station voulue s'affiche, utilisez le bouton **+** ou **-** pour augmenter ou diminuer la durée de réessuyage. Vous pouvez régler le temps de réessuyage entre 1 minute et 4 heures par incréments d'une minute.



Remarque: Seules les minutes sont affichées pour moins d'une heure (par exemple : 36). Au-delà d'une heure, l'écran change et inclut les heures (par exemple : 1:13 et 4:00)

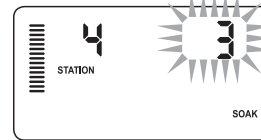

Exemple d'écran de réessuyage avec seulement les minutes

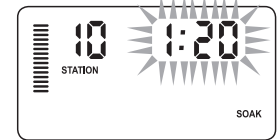

Exemple d'écran de réessuyage avec heures comprises

Problèmes d'arrosage et de réessuyage :

La station 1 nécessite 20 minutes d'arrosage mais, au bout de 5 minutes, un ruissellement se produit. Toutefois, après 10 minutes, toute l'eau est absorbée.

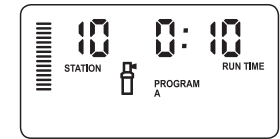

La solution consisterait à programmer une durée d'arrosage de 20 minutes pour la station, une durée de cycle de 5 minutes et une durée de réessuyage de 10 minutes.

La durée de réessuyage est un minimum. La durée de réessuyage peut être plus longue en fonction des durées d'arrosage restantes.





Cycle de fonctionnement station 10

GUIDE DE DÉPANNAGE

Problèmes	Causes	Solutions
Le programmeur fonctionne en permanence	Trop de départs de cycles ont été programmés	Seulement une heure départ est nécessaire pour activer un cycle complet d'arrosage (consulter la partie Réglages des départs de cycle page 18)
Aucune information ne s'affiche sur l'écran	Vérifier l'alimentation secteur et le raccordement	Corriger les erreurs éventuelles de câblage ou d'alimentation
L'écran affiche « NO AC » (Pas d'alimentation)	Pas d'alimentation secteur 220 Volts au niveau du programmeur	Vérifier le raccordement du transformateur et l'arrivée 220 Volts
L'écran affiche le mot « OFF » et les icônes  	La sonde de pluie interrompt l'arrosage ou le cavalier de la sonde a été retiré	Positionner l'interrupteur de contournement de la sonde de pluie sur ARRÊT afin d'ignorer le circuit de la sonde de pluie, ou réinstallez le cavalier
La sonde n'interrompt pas l'arrosage	La sonde est défectueuse ou mal raccordée Le cavalier n'a pas été enlevé lors de l'installation de la sonde Les stations ont été programmées pour ne pas tenir compte de la sonde	Vérifier le fonctionnement et le câblage de la sonde Retirer le cavalier des bornes de la sonde Reprogrammer l'annulation de la sonde pour l'activer (voir page 11)
Écran bloqué ou des informations affichées sont incorrectes	Il y a eu une surtension	Réinitialiser le programmeur en suivant les instructions page 24 de « Effacer la mémoire du programmeur / Remise à zéro du programmeur »
L'écran affiche un message « ERR » avec un chiffre de 1 à 8	Court circuit sur les câbles de la vanne en question ou solénoïde défectueux sur la station indiquée	Vérifier les câbles ou le solénoïde pour la vanne indiquée. Réparer le câblage ou remplacer le solénoïde. Appuyer sur n'importe quelle touche pour effacer le message « ERR »
L'écran affiche « P ERR »	Défaut du câblage du relais démarrage de pompe ou de la vanne maîtresse Relais ou solénoïde incompatible ou défectueux Câbles sous-dimensionnés vers le relais démarrage de pompe ou la vanne maîtresse	Vérifier le câblage vers le relais démarrage de pompe ou le solénoïde de la vanne maîtresse. Appuyer sur n'importe quelle touche pour effacer le message « P ERR » Vérifier les spécifications électriques du relais démarrage de pompe. Ne pas excéder les spécifications électriques du programmeur. Le remplacer s'il est défectueux Remplacer les fils par d'autres de plus grande section

GUIDE DE DÉPANNAGE

Problèmes	Causes	Solutions
L'écran affiche qu'une station fonctionne mais les icônes  et  clignotent	La sonde interrompt l'arrosage, cependant, la station a été programmée pour ne pas tenir compte du signal de la sonde	Vérifier la programmation de la sonde pour la station (voir page 23)
L'arrosage automatique ne démarre pas à l'heure prévue mais le programmeur n'est pas en mode arrêté « OFF »	Le réglage AM/PM (matin/après-midi) de l'heure du jour n'est pas réalisé correctement. (Ne pas tenir compte si vous avez choisi l'horloge 24H) Le réglage AM/PM (matin/après-midi) de l'heure du départ de cycle n'est pas réalisé correctement. (Ne pas tenir compte si vous avez choisi l'horloge 24H) Le départ de cycle est désactivé « OFF » Le programmeur ne reçoit pas l'alimentation Il n'y a pas d'eau au départ	Corriger le réglage AM/PM de l'heure du jour si vous n'utilisez pas d'horloge 24H Corriger le réglage AM/PM de l'heure de départ du cycle si vous n'utilisez pas d'horloge 24H Mettre le sélecteur sur MARCHÉ Vérifier les raccordements électriques Vérifier l'alimentation en eau
L'affichage présente des pointillés lorsque la molette est en position « Solar Sync Paramètres »	<ul style="list-style-type: none"> Le capteur Solar Sync n'est pas connecté au contrôleur Les fils du capteur Solar Sync peuvent être rompus ou avoir une mauvaise connexion 	Connectez le capteur Solar Sync sur les repères « SEN » du bornier. L'affichage présente alors les paramètres correspondant à la région et au réglage du débit
Le temps d'utilisation d'une station est trop court ou trop long	Le temps d'utilisation programmé est trop long ou court	Solar Sync permet de régler le contrôleur en fonction des saisons. Si une station a été utilisée trop ou pas assez longtemps, réglez le contrôleur en conséquence. Assurez-vous que les paramètres saisonniers sont à nouveau réglés sur 100 % avant de modifier les temps d'utilisation. Pour ce faire, placez la molette sur la position Seasonal Adjust (Réglage saisonnier) et augmentez/réduisez la valeur pour obtenir 100 %
La valeur saisonnière semble basse	Débit d'eau trop important pour la région Réglage trop bas Le capteur n'est pas positionné en plein soleil	Augmentez la valeur de la gradation Water Adjustment (Réglage de l'eau), la valeur par défaut est de 5 Si vous sélectionnez la valeur maximale, 10, mais devez encore régler les valeurs saisonnières, sélectionnez une région inférieure d'une unité (de 4 à 3, par exemple) puis définissez le paramètre Water Adjustment sur 5. Solar Sync met immédiatement à jour le paramètre saisonnier sur le contrôleur. Si ce dernier reste trop faible, répétez le réglage jusqu'à ce que la valeur saisonnière voulue s'affiche sur le contrôleur

GUIDE DE DÉPANNAGE

Problèmes	Causes	Solutions
La valeur saisonnière semble haute	<ul style="list-style-type: none"> • Numéro de région trop bas • Paramètre « Water Adjustment » (Réglage de l'eau) trop élevé 	Réduisez la valeur du paramètre « Water Adjustment » (Réglage de l'eau). Si vous sélectionnez la valeur minimale, 1, mais devez encore régler les valeurs saisonnières, sélectionnez une région inférieure d'une unité (de 2 à 3, par exemple) puis définissez le paramètre du réglage de l'eau sur 5. Solar Sync met immédiatement à jour le paramètre saisonnier sur le contrôleur. Si ce dernier reste trop élevé, répétez le réglage jusqu'à ce que la valeur saisonnière voulue s'affiche sur le contrôleur
La sonde Solar Sync continue d'envoyer les réglages saisonniers lorsque l'interrupteur de contournement du programmeur est en position « Bypass » (arrêt)	Le réglage saisonnier automatique de Solar Sync ne peut pas être désactivé par l'interrupteur « Bypass » (arrêt). L'interrupteur contrôle uniquement la fonction d'arrêt en cas de pluie/gel de Solar Sync	

SPECIFICATIONS

Caractéristiques Techniques

- Temps d'arrosage de station : 1 minute à 4 heures par incréments de 1 minute
- 3 programmes d'arrosage indépendants
- Départs de cycle : 4 par jour et par programme, et jusqu'à 12 départs quotidiens
- Jours d'arrosage : calendrier de 365 jours, arrosage par intervalle, arrosage jours pair/impair, ou par jour de la semaine
- Option horloge AM/PM (Matin, Après-midi) ou 24 heures
- Marche manuelle simple
- Désactivation de sonde par station programmable
- Arrêt d'arrosage programmable (de 1 à 7 jours)
- Réglage saisonnier manuel (de 10 % à 150 %)
- Réglage saisonnier automatique avec la sonde Solar Sync
- Interrupteur de contournement de la sonde
- XC-x00i modèle intérieur. XC-x00 modèle extérieur
- Altitude maxi 2000m de 0°C à 50°C

Dimensions

Boîtier d'intérieur

- Hauteur : 16,5 cm
- Largeur : 14,6 cm
- Profondeur : 5 cm

Boîtier d'extérieur

- Hauteur : 22 cm
- Largeur : 17,8 cm
- Profondeur : 9,5 cm

Caractéristiques électriques

- Entrée transformateur : 230/240 Volts, $\pm 10\%$ 50/60Hz
- Sortie transformateur : 24 Volts, 1,0 A
- Sortie station : 0,56 A par station
- Sortie maximum : 0,90 A (y compris vanne maîtresse)
- Pile : pile de 3 Volts au lithium fournie pour programmation sans 220 Volts et conservation de l'heure. Reference de la pile : CR2032-3 volts (en cas de remplacement)
- Protection électronique contre les courts-circuits
- Mémoire non volatile pour sauvegarder les données du programme
- Conforme aux normes CE, UL, et C-Tick
- Le classement du modèle XC-x00 est IP24 pour le degré 4 de pollution
- Pour le nettoyage utiliser un linge humidifié avec du savon doux et de l'eau

Légende des symboles

~ = Courant Alternatif



= Consulter la documentation













= Tensions dangereuses









= Terre

INDICE

COMPONENTI DEL PROGRAMMATORE X-CORE	2
MONTAGGIO A MURO DEL PROGRAMMATORE	6
COLLEGAMENTO DELLE VALVOLE E DEL TRASFORMATORE	7
ATTIVAZIONE DELLA BATTERIA	8
SOSTITUZIONE DELLA BATTERIA	8
COLLEGAMENTO DELLA VALVOLA PRINCIPALE	9
COLLEGAMENTO DEL RELÈ DI POMPA	10
COLLEGAMENTO DEL PLUVIOMETRO	11
Verifica del funzionamento del pluviometro.....	11
Esclusione manuale del pluviometro.....	11
PROGRAMMAZIONE DEL MODULO SOLAR-SYNC	12
Installazione del sensore Solar Sync.....	12
Installazione di Wireless Solar Sync.....	12
Impostazioni Solar Sync®.....	12
Regioni 	13
Regolazione dell'irrigazione 	14
Disinstallazione del sensore Solar Sync.....	14
Calibrazione/Impostazione.....	15
FUNZIONALITÀ RITARDO SOLAR SYNC	16
CONNESSIONE A UN TELECOMANDO HUNTER	17
Connessione a un telecomando Hunter (non incluso).....	17
Come installare il connettore Smart Port®.....	17
INTERRUZIONI DI ALIMENTAZIONE	17
PROGRAMMAZIONE DEL PROGRAMMATORE	18
Regolazione del giorno e dell'ora 	19
Regolazione degli orari di partenza dei programmi 	19
Cancellazione di una partenza programmata.....	19
Regolazione dei tempi d'irrigazione 	19
Regolazione dei giorni d'irrigazione 	19
Selezione di giorni specifici della settimana.....	20
Selezione dei giorni pari/dispari per l'irrigazione.....	20
Selezione degli intervalli d'irrigazione 	20
Regolazione del/i giorno/i di non irrigazione.....	20
Funzionamento automatico 	21
Arresto dell'impianto 	21
Spegnimento sistema d'irrigazione programmabile.....	21
Regolazione stagionale %.....	21
Avvio manuale di una sola stazione 	22
Avvio manuale One Touch e avanzamento.....	22
FUNZIONALITÀ AVANZATE	23
Esclusione programmabile del sensore.....	23
Programma di verifica di tutte le stazioni.....	23
Hunter Quick Check®: funzione di diagnosi.....	23
Memorizzazione di un programma Easy Retrieve™.....	24
Ritardo programmabile tra le stazioni.....	24
Azzeramento della memoria/reset del programmatore.....	24
RITARDO CLIK: ISTRUZIONI	25
Personalizzazione dei programmi.....	26
Accès au menu Réessuyage.....	27
FUNZIONI NASCOSTE	27
GUIDA ALLA RISOLUZIONE DEI PROBLEMI	28
SPECIFICHE.....	31
Specifiche di funzionamento.....	31
Specifiche elettriche.....	31
Legenda.....	31
CERTIFICATO DI CONFORMITÀ ALLE DIRETTIVE EUROPEE	32

COMPONENTI DEL PROGRAMMATORE X-CORE

A Schermo LCD

1	 Regolazione tempi d'irrigazione	Consente di impostare il tempo di funzionamento di ciascuna stazione-valvola da un minuto a 4 ore
2	 Regolazione partenze	Consente di impostare per ciascun programma da 1 a 4 orari di partenza
3	Numero di stazione	indica il numero della stazione attualmente selezionata
4	Indice di programma	Identifica il programma usato (A, B o C)
5	Giorno della settimana	Identifica il giorno della settimana
6	Intervallo d'irrigazione	Identifica il mese durante la programmazione della data corrente
7	Irrigazione giorni pari/dispari	Identifica se è stata selezionata la modalità d'irrigazione giorni pari/dispari
8	Irrigatore intermittente	Indica che l'irrigazione è in corso
9	 Spento	Consente all'utente di interrompere tutti i programmi e l'irrigazione. Consente all'utente anche di impostare uno spegnimento programmato che blocca l'irrigazione per un periodo che va da 1 a 7 giorni
10	 Ombrello	Indica che il pluviometro è attivo
11	% Regolazione stagionale	Permette all'utente di modificare i tempi d'irrigazione in funzione delle variazioni climatiche senza dover modificare la programmazione. Le barre a sinistra consentono di visualizzare rapidamente la percentuale di regolazione stagionale
12	 Goccia di pioggia	Indica che l'irrigazione si effettuerà il giorno selezionato
13	 Goccia di pioggia barrata	Indica che l'irrigazione NON si effettuerà il giorno selezionato
14	 Calendario	Indica che è stato programmato un intervallo tra irrigazioni. L'icona appare anche quando si sta programmando la data corrente

COMPONENTI DEL PROGRAMMATORE X-CORE

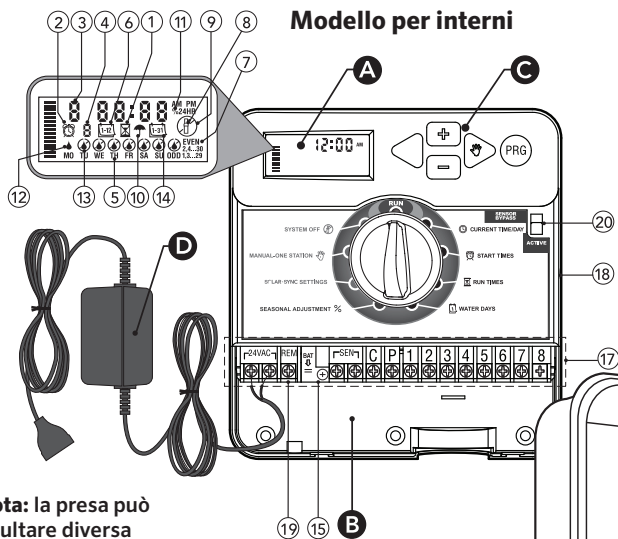



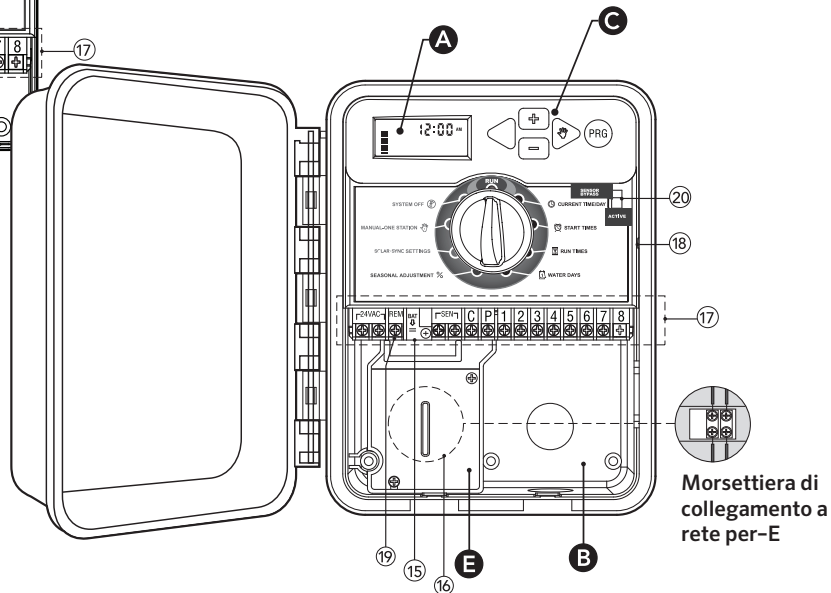

Nota: la presa può risultare diversa da quella riportata nell'illustrazione.







**Modello per esterni
(trasformatore interno incorporato)**



COMPONENTI DEL PROGRAMMATORE X-CORE

B Vano cavi		
15	Batteria al litio	La batteria al litio sostituibile (compresa nella fornitura) consente di programmare il programmatore in assenza di alimentazione CA. Inoltre, la batteria fornisce l'alimentazione necessaria per alimentare l'orologio interno nel caso di interruzione di corrente
16	Cassetta di derivazione interna	Cassetta di derivazione nei modelli per esterni, per effettuare i collegamenti di corrente (CA)
17	Morsettiera	Usata per collegare il trasformatore, il sensore e i cavi delle valvole al programmatore
18	18 Tasto di reset	Da adoperare nella procedura per resettare il programmatore
19	19 REM	Permette il collegamento a Hunter SmartPort e ai telecomandi Hunter
20	Interruttore di esclusione sensore	Ignora l'input del sensore meteo "Clik" in modalità Bypass
C Pulsanti di comando		
	Pulsante 	Permette di aumentare il valore intermittente selezionato
	Pulsante 	Permette di diminuire il valore intermittente selezionato
	Pulsante 	Riporta la visualizzazione selezionata alla voce precedente
	Pulsante 	Porta la visualizzazione selezionata alla voce successiva
	Pulsante 	Permette di selezionare il programma A, B o C corrispondente alle varie esigenze d'irrigazione

COMPONENTI DEL PROGRAMMATORE X-CORE

Impostazioni selettore rotativo di comando		
	Acceso	Posizione normale che permette il funzionamento automatico e manuale
	Regolazione giorno/ ora	Permette di regolare il giorno e l'ora correnti
	Regolazione partenze	Consente di impostare per ciascun programma da 1 a 4 tempi di avvio
	Regolazione tempi d'irrigazione	Consente di impostare il tempo di funzionamento di ciascuna stazione-valvola da 1 minuto a 4 ore
	Regolazione giorni d'irrigazione	Permette di selezionare i giorni d'irrigazione
	Regolazione stagionale	Permette all'utente di modificare i tempi d'irrigazione in funzione delle variazioni stagionali senza dover modificare la programmazione. Le barre a sinistra consentono di visualizzare rapidamente la percentuale di regolazione stagionale
	Funzionamento manuale - Una stazione	Lancia una volta l'irrigazione in una singola stazione/valvola
	Spento	Consente all'utente di interrompere tutti i programmi e l'irrigazione. Consente all'utente anche di impostare uno spegnimento programmato che blocca l'irrigazione per un periodo che va da 1 a 7 giorni
	Impostazioni di SOLAR SYNC®	Permette all'utente di programmare le impostazioni per l'utilizzo del sensore Solar Sync ET
D Trasformatore esterno (solo nel modello per interni)		
		Sul trasformatore è prevista una presa per collegare il programmatore all'alimentazione CA

MONTAGGIO A MURO DEL PROGRAMMATORE



NOTA: il modello per interni del programmatore X-Core non è progettato per resistere all'acqua e alle intemperie. Perciò dovrà essere installato solo all'interno o in un luogo riparato.

1. Avvitare una vite nel muro. Usare i tasselli per fissare il programmatore sui muri in pietra o in mattoni.
2. Far scivolare l'intaglio situato sulla parte alta del programmatore, sulla vite.
3. Fissare il programmatore inserendo le viti nei fori sotto la zona della morsettiera di collegamento.



NOTA: Non collegare il trasformatore fino a quando il programmatore non sia completamente montato e tutte le valvole siano state collegate.



NOTA: lo sportello dei programmatori per esterni deve rimanere chiuso per la massima resistenza all'acqua.



NOTA: lo sportello dei programmatori per esterni deve rimanere chiuso per la massima resistenza all'acqua.

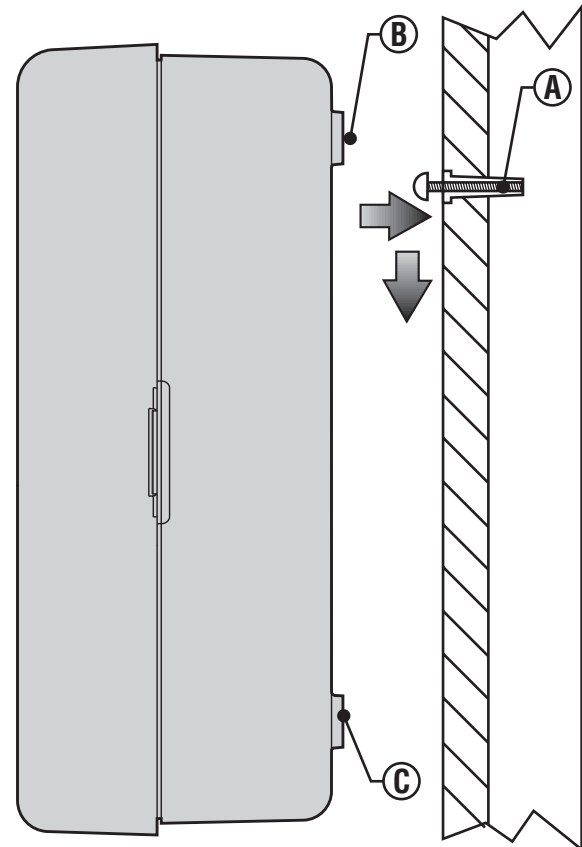

COLLEGAMENTO DELLE VALVOLE E DEL TRASFORMATORE

L'installazione della X-Core dovrebbe essere realizzata solo da personale specializzato.

1. Stendere i fili delle valvole tra il pozzetto delle valvole ed il programmatore.
2. Sul gruppo valvole, connettere il filo comune ad uno dei fili del solenoide di ogni valvola. In generale si usa il filo bianco. Collegare un altro filo al filo rimanente di ogni valvola. Collegare i fili con un connettore stagno per proteggere le connessioni.
3. Stendere i fili delle valvole attraverso la condotta. Fissare la condotta dalla parte in basso a destra del programmatore.
4. Fissare il filo comune bianco delle valvole alla vite del morsetto (comune) C. Collegare i fili di ciascuna valvola ai morsetti della stazione corrispondente e stringere le viti.
5. Modelli per interni: far passare il cavo del trasformatore attraverso l'apertura situata sul lato sinistro del programmatore e collegare i fili alle due viti identificate con 24VAC.

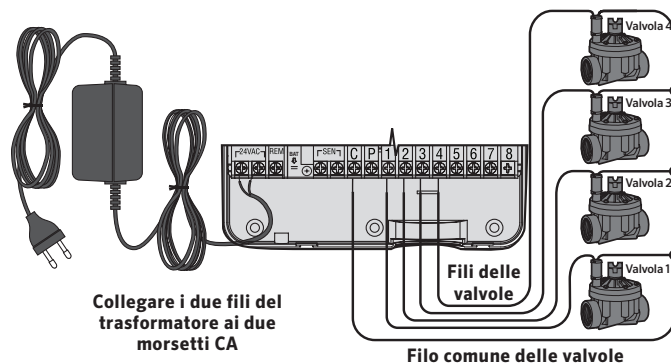

ⓘ Comparto cavi ad alta tensione (solo modello per esterni)

1. Inserire il cavo di alimentazione CA e la condotta attraverso la relativa apertura di 13 mm a sinistra nella base della centralina.
2. Collegare fase e neutro alla morsettiere posta all'interno della cassetta di derivazione. Il cavo di messa a terra deve essere collegato al cavo verde. Per i collegamenti dei cavi utilizzare i connettori forniti. Nota: nei modelli -E, collegare i cavi alla morsettiere CA ubicata all'interno della cassetta di derivazione. I cavi di alimentazione di CA dovranno essere 14 AWG (1.85 mm) o più spessi con un appropriato circuito di disconnessione in funzione del cavo adoperato. Un interruttore o una apertura di circuito dovrebbero essere previsti durante l'installazione nelle vicinanze del programmatore, essere di facile accesso per l'operatore ed essere segnalate come un dispositivo di disconnessione dell'apparecchiatura.
3. Riposizionare la protezione della scatola di derivazione.



NOTA: il cavo del trasformatore dei modelli per interni non può essere tagliato. Se il cavo viene tagliato, i fili rosso e bianco nel cavo devono essere uniti, altrimenti il programmatore non funzionerà.

Modelli per esterni: i fili del trasformatore sono già collegati ai morsetti CA, per cui basta solo effettuare il collegamento dell'alimentazione principale con la scatola di derivazione.



NOTA: i modelli per esterni del programmatore X-Core sono resistenti all'acqua e alle intemperie. Il collegamento dell'X-Core esterno all'alimentazione primaria CA deve essere effettuato esclusivamente da un elettricista professionista, conformemente a quanto previsto dalla normativa locale. Un'installazione non corretta potrebbe comportare il rischio di shock elettrico o incendio.

ATTIVAZIONE DELLA BATTERIA

Dopo aver installato il programmatore X-Core, accertarsi di aver rimosso l'isolatore di contatto della batteria per consentire all'X-Core di mantenere l'ora in caso di un'interruzione di corrente.

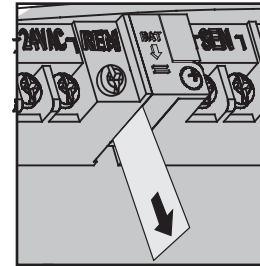

ATTENZIONE:

Rischio Di Esplosione Se La Batteria Viene Sostituita Con Un Modello Sbagliato. Disporre Delle Batterie Esauste Secondo Le Istruzioni.

SOSTITUZIONE DELLA BATTERIA

Con il programmatore XC è compresa una batteria al litio ad alta potenza. La batteria consente all'utente di programmare in remoto il programmatore senza necessità di collegarsi all'alimentazione CA. Serve anche a mantenere attiva l'impostazione di giorno e di ora nel caso di interruzioni di alimentazione. Per sostituire la batteria:

1. Rimuovere la vite dal porta-batteria.
2. Fare scorrere verso il basso il porta-batteria ed accedere al vano batteria.
3. Rimuovere e sostituire la nuova batteria inserendola nel vano batteria, quindi reinserire il porta-batteria.

Batteria

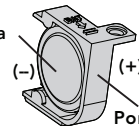

Porta-batteria

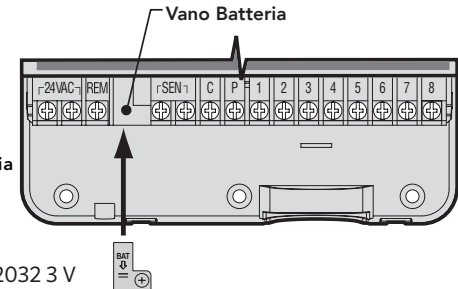

Tipo di batteria: CR2032 3 V



NOTA: il lato positivo (+) della batteria dovrebbe guardare l'interno del porta-batteria.

COLLEGAMENTO DELLA VALVOLA PRINCIPALE



NOTA: il presente capitolo riguarda esclusivamente gli impianti dotati di valvola principale. La valvola principale è una valvola normalmente chiusa installata nel punto di alimentazione della linea principale, che si apre solo quando il programmatore avvia un programma d'irrigazione.

1. All'altezza della valvola principale, raccordare il filo comune ad uno dei fili del solenoide di ciascuna valvola. Collegare un altro filo al filo rimanente del solenoide.
2. Collegare il filo comune al morsetto **C** all'interno del programmatore. L'altro filo proveniente dalla valvola principale deve essere collegato al morsetto **P** all'interno del programmatore. Stringere le viti dei morsetti.

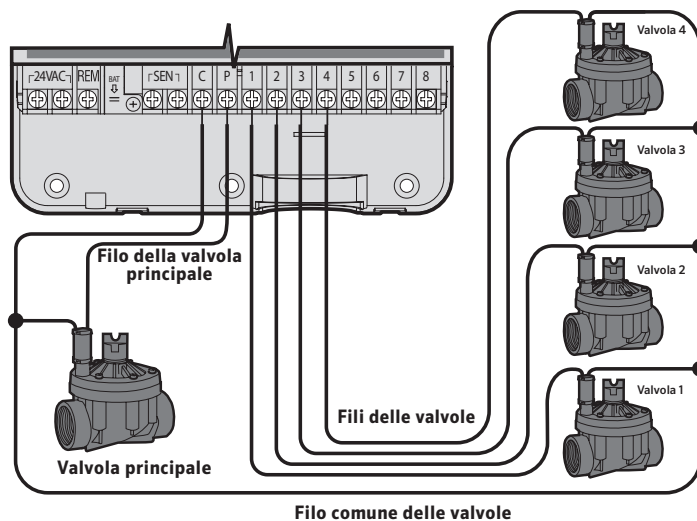

COLLEGAMENTO DEL RELÈ DI POMPA



NOTA: il presente capitolo riguarda esclusivamente gli impianti dotati relè di pompa. Il relè della pompa è un dispositivo che utilizza un impulso del programmatore per attivare un circuito elettrico separato che, a sua volta, controlla la messa in funzione di una pompa per alimentare l'impianto di irrigazione.

Il programmatore deve essere montato a min. 4,5 m dal relè di innesco della pompa e dalla pompa stessa, per ridurre al minimo eventuali interferenze elettriche.

1. Far correre i due fili del relè della pompa verso il programmatore.
2. Raccordare il filo comune alla vite **C** (comune: in genere un filo bianco) all'interno del programmatore e collegare l'altro filo proveniente dal relè della pompa alla vite **P**.

Il consumo del relè non deve superare 0,30 A. Non collegare il programmatore direttamente alla pompa perché potrebbe esserne danneggiato.

<http://www.hunterindustries.com/support/controllers/pump-start-relay>

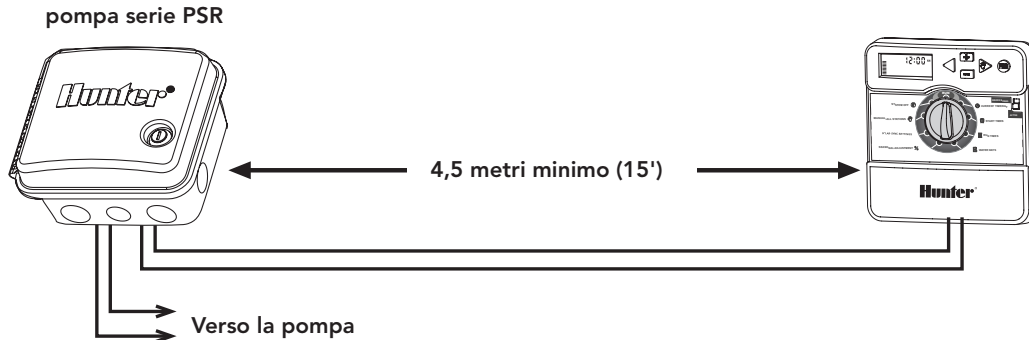

COLLEGAMENTO DEL PLUVIOMETRO

Al programmatore X-Core si possono collegare sia un pluviometro Hunter che un pluviometro a contatto. Lo scopo del pluviometro è quello di fermare l'irrigazione automatica quando le condizioni meteo la rendono superflua.

1. Smontare il ponticello fissato ai morsetti SEN del programmatore.
2. Raccordare un filo al morsetto identificato con SEN e l'altro all'altro morsetto che porta la stessa indicazione.

Sensore pioggia Mini-Clik®

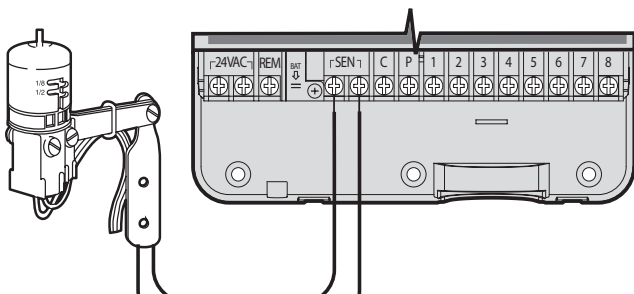

NOTA: l'attivazione dell'interruttore di esclusione del sensore non influisce sugli aggiornamenti della regolazione stagionale del sensore Solar Sync. Escluderà soltanto la funzionalità Rain-Clik e Freeze-Clik del sensore.

Una volta che il pluviometro ha disattivato l'irrigazione automatica, i simboli OFF, e  appariranno sul display.



Verifica del funzionamento del pluviometro

Con il programmatore X-Core è possibile eseguire un test semplice del sensore pioggia collegato al circuito del sensore. È possibile verificare manualmente il corretto funzionamento del sensore pioggia eseguendo un **CICLO AUTOMATICO** o attivando l'impianto utilizzando il **ciclo automatico CON UN SOLO TOCCO**. Durante il ciclo manuale, premere il perno superiore sul sensore Hunter per interrompere l'irrigazione.

Esclusione manuale del pluviometro

Se il sensore pioggia ha interrotto l'irrigazione, è possibile inibirne il funzionamento con l'apposito interruttore di esclusione, posto nella parte frontale del programmatore. Portare l'interruttore in posizione di **ESCLUSIONE SENSORE** per disattivare il sensore pioggia e consentire il funzionamento del programmatore. È possibile bypassare il pluviometro in funzionamento manuale anche usando la funzione **FUNZIONAMENTO MANUALE - UNA STAZIONE**.



Quando si utilizza la funzione **FUNZIONAMENTO MANUALE-UNA STAZIONE**, il programmatore escluderà automaticamente gli ingressi del sensore per il tempo specificato. Al termine, verranno ripristinate le impostazioni predefinite del programmatore.

PROGRAMMAZIONE DEL MODULO SOLAR-SYNC

X-Core è compatibile con i sistemi Solar Sync e Wireless Solar Sync. Solar Sync è un sistema di sensori in grado di regolare automaticamente il piano di irrigazione del programmatore X-Core (in base al variare delle condizioni climatiche locali) mediante l'impiego della funzione di regolazione stagionale. Solar Sync impiega un sensore solare e di temperatura per determinare il grado di evapotraspirazione (ET) o il grado di assorbimento dell'acqua da parte di piante e terreno; inoltre, grazie alla tecnologia Rain Klik e Freeze Klik di Hunter, prevede l'interruzione automatica dell'irrigazione in caso di pioggia o gelate.



NOTA: Solar Sync applica un valore di regolazione stagionale predefinito pari al 100% fino al ricevimento dei valori climatici misurati dell'intera prima giornata di funzionamento (24 ore) del sensore.



NOTA: L'attivazione dell'interruttore bypass del sensore non ha alcun effetto sugli aggiornamenti della regolazione stagionale ricevuti dal sensore Solar Sync. Esso disattiverà, tuttavia, le funzioni Rain Klik e Freeze Klik del sensore.



NOTA: L'installazione del modulo Solar Sync non è obbligatoria per l'utilizzo del programmatore X-Core.

Installazione del sensore Solar Sync

Collegare i cavi verde e nero del sensore Solar Sync ai terminali di cablaggio "SEN" del programmatore X-Core. Non importa quale cavo viene accoppiato a quale terminale. Ruotare il selettore nella posizione "Solar Sync Settings". Sul display vengono inizialmente

visualizzate delle linee tratteggiate, quindi l'impostazione dell'area predefinita (3) sulla sinistra e l'impostazione di regolazione dell'acqua predefinita (5) sulla destra.

Installazione di Wireless Solar Sync

Collegare i cavi verde e nero del ricevitore Wireless Solar Sync ai terminali di cablaggio "SEN" del programmatore X-Core. Non importa quale cavo viene accoppiato a quale terminale. Ruotare il selettore nella posizione "Solar Sync Settings". Sul display vengono inizialmente visualizzate delle linee tratteggiate, quindi l'impostazione dell'area predefinita (3) sulla sinistra e l'impostazione di regolazione dell'acqua predefinita (5) sulla destra.





Impostazioni Solar Sync

Una volta che il sensore Solar Sync è collegato al programmatore X-Core, sul display vengono visualizzati due numeri e le impostazioni Solar Sync possono essere programmate. Il numero riportato sulla sinistra dello schermo corrisponde all'impostazione dell'area, mentre il numero riportato sulla sinistra corrisponde all'impostazione della regolazione acqua (vedere immagine con display e impostazioni area e regolazione acqua).

Per eseguire misurazioni Solar Sync accurate, nel programmatore deve essere configurato il valore ET tipico (evapotraspirazione media in alta stagione) della propria area geografica. Per determinarlo,

PROGRAMMAZIONE DEL MODULO SOLAR-SYNC

utilizzare la tabella riportata qui sotto. Utilizzare i pulsanti  o  per selezionare la propria area geografica (1-4).

Regione

Per ottenere delle misurazioni esatte da parte del Solar Sync, il programmatore deve essere impostato sull' ET media di picco per la regione dove è installato.

Servirsi della tabella per identificare il tipo a cui appartiene la propria regione. Le regioni ET di base disponibili sono quattro, per ciascuna delle quali è fornita la descrizione e le caratteristiche tipiche di temperatura ed evapotraspirazione. Ove possibile, si raccomanda di scegliere la regione in base all'ET media giornaliera del mese più caldo o dei picchi estivi (mm/pollici).

Adoperare la seguente tabella per scegliere la propria regione. Utilizzare la riga **A**, **B** o **C** per scegliere la regione più adatta alla propria zona:

A: In base all'ET della propria regione utilizzando l'ET media giornaliera del mese più caldo o del picco estivo (mm/pollici).
È l'opzione migliore per la scelta della propria regione.

B: In base alla temperatura della propria regione utilizzando la temperatura media di luglio o la temperatura massima del mese più secco (e non la temperatura massima del mese di luglio).

C: In base alla descrizione generale della propria regione.

L'OPZIONE NELLA RIGA CORRISPONDENTE ALLA PROPRIA SITUAZIONE, COSTITUISCE L'IMPOSTAZIONE DA SCEGLIERE PER LA PROPRIA REGIONE.			
	A	B	C
Region 1	Se l'ET media giornaliera del mese più caldo è < 4,3 mm (0,17")	Se la temperatura massima media del mese più caldo è 18°C-24°C (65° F-75°F)	<ul style="list-style-type: none"> • Stati americani del nord • Regioni costiere
Region 2	Se l'ET media giornaliera del mese più caldo è 4,6 mm-5,8 mm (0,18"-0,23")	Se la temperatura massima media del mese più caldo è 24°C-29°C (75° F-85°F)	<ul style="list-style-type: none"> • Zone montuose • Stati interni del nord America
Region 3	Se l'ET media giornaliera del mese più caldo è 6,1 mm-7,4 mm (0,24"-0,29")	Se la temperatura massima media del mese più caldo è 29°C-35°C (85° F-95°F)	<ul style="list-style-type: none"> • Stati americani del sud • Zone interne/ Altopiani secchi
Region 4	Se l'ET media giornaliera del mese più caldo è > 7,6 mm (0,30")	Se la temperatura massima media del mese più caldo è 35°C-41°C (95° F-105°F)	<ul style="list-style-type: none"> • Deserti

*Per i paesi nell'emisfero sud usare normalmente gennaio.

PROGRAMMAZIONE DEL MODULO SOLAR-SYNC

Regolazione dell'irrigazione ↑↓

Se il clima della propria zona è più umido o più secco del previsto, è disponibile una funzione di regolazione dell'irrigazione che modifica uniformemente l'irrigazione per tutte le stazioni. Utilizzare il pulsante → fino a quando la freccia non si trova in corrispondenza dell'icona ↑↓. Utilizzare il pulsante + o - per aumentare o diminuire la quantità di irrigazione da 1 a 10 (1 per l'irrigazione minima, 10 per la massima). Prima di procedere alla regolazione dell'irrigazione, Hunter raccomanda di monitorare attentamente il rendimento nelle prime settimane di funzionamento.



Nota: se il clima di una determinata zona risulta più umido o più secco rispetto al resto del sistema, è sufficiente aumentare o diminuire il tempo di funzionamento del programmatore.

Disinstallazione del sensore Solar Sync

Se sul programmatore X-Core è stato installato un sensore Solar Sync, il valore di regolazione stagionale utilizzato dal programmatore viene calcolato a partire dai dati climatici raccolti dal sensore Solar Sync. Se si decide di non utilizzare più il sensore Solar Sync con il programmatore X-Core, il sensore deve essere disinstallato. **Se il sensore Solar Sync non viene disinstallato, non sarà possibile modificare manualmente il valore di regolazione stagionale del programmatore.** Ad esempio, se il valore di regolazione stagionale visualizzato sul programmatore è pari al 50% quando il sensore Solar Sync viene rimosso, esso resterà inalterato fino a quando il sensore non viene disinstallato.

Per disinstallare il sensore Solar Sync è sufficiente scollegare i cavi verde e nero dal terminale del programmatore, quindi ruotare il selettore nella posizione "Imp. Solar Sync". Sul display dovrebbero essere visualizzati dei trattini, a indicare che il programmatore non riconosce più il sensore Solar Sync per il calcolo della regolazione stagionale. A questo punto, è possibile modificare manualmente il valore di regolazione stagionale ruotando il selettore nella posizione "Regolazione stagionale" e utilizzando i pulsanti + o - per impostare il valore.

PROGRAMMAZIONE DEL MODULO SOLAR-SYNC

Calibrazione/Impostazione

Dopo aver installato e programmato Solar Sync, vi consigliamo di far funzionare il sistema con le impostazioni iniziali per alcuni giorni. A causa della diversità delle condizioni ambientali (posizione dei sensori, quantità di luce diretta del sole che riceve il sensore, calore riflesso dalle strutture circostanti, e così via) è **possibile che sia necessario regolare le impostazioni iniziali per ottenere le prestazioni desiderate**. L'esecuzione della calibrazione di Solar Sync per un particolare ambiente è molto semplice, occorre solo intervenire sulle impostazioni di regolazione ambientali e dell'acqua. Per eseguire questo processo, attenetevi alle seguenti istruzioni:

1. Installate il sensore Solar Sync e programmate il modulo come descritto alle pagine 15.
2. Lasciate funzionare il sistema con le impostazioni iniziali per almeno 3 giorni.
3. Osservate la regolazione stagionale del programmatore. Se i valori di regolazione stagionale sono più bassi o più alti del previsto per il periodo dell'anno, le impostazioni di Solar Sync vanno regolate.
 - a. **Regolazione stagionale troppo bassa:** aumentate il valore per la regolazione dell'acqua (l'impostazione predefinita è 5). Dopo aver modificato l'impostazione, il programmatore si aggiorna automaticamente sulla nuova % di regolazione stagionale. Aumentate il valore dell'impostazione per la regolazione dell'acqua fino a che non viene mostrata la % di regolazione stagionale desiderata. **Se impostate la regolazione dell'acqua sul valore massimo 10 e occorre ancora intervenire sulle regolazioni stagionali, spostate la regolazione ambientale su un livello più basso, ad esempio da 4 a 3.**
 - b. **Regolazione stagionale troppo alta:** riducete il valore per la regolazione dell'acqua (l'impostazione predefinita è 5). Dopo aver modificato l'impostazione, il programmatore si aggiorna automaticamente sulla nuova % di regolazione stagionale. Riducete il valore dell'impostazione per la regolazione dell'acqua fino a che non viene mostrata la % di regolazione stagionale desiderata. **Se impostate la regolazione dell'acqua sul valore minimo 1 e occorre ancora intervenire sulle regolazioni stagionali, spostate la regolazione ambientale su un livello superiore, ad esempio da 2 a 3.**

Tempi di funzionamento della stazione: è importante tenere presente che Solar Sync fornisce una regolazione stagionale globale al programmatore e questo vuol dire che la percentuale di regolazione stagionale mostrata incide su tutti i tempi di funzionamento della stazione. Durante la programmazione del programmatore è necessario specificare i tempi di funzionamento dei piani di irrigazione per i periodi di picco delle stagioni. Se Solar Sync viene impostato sul valore di regolazione stagionale corretto, ma il tempo di funzionamento di una particolare stazione risulta eccessivo o insufficiente, regolate il tempo di funzionamento della stazione nel programmatore.

FUNZIONALITÀ RITARDO SOLAR SYNC

Ritardo Solar Sync per X-CORE®

La funzione di ritardo è disponibile solo dopo aver installato Solar Sync. La funzione Ritardo Solar Sync consente di rimandare l'applicazione delle modifiche di regolazione stagionale apportate da Solar Sync fino a 99 giorni.

Quando il ritardo Solar Sync è attivo, Solar Sync continua a raccogliere e memorizzare i dati.

Funzionamento:

Per accedere all'impostazione Ritardo Solar Sync:

1. Spostare il selettore in posizione **ACCESO**; premere e tenere premuto il pulsante **+**, ruotare il selettore in posizione Solar Sync, quindi rilasciare il pulsante **+**. Viene visualizzata la seguente schermata: **d:XX** (in cui **d** indica i giorni, mentre **XX** il numero di giorni impostati per il ritardo).
2. Premere il pulsante **+** o **-** per aumentare/diminuire il numero di giorni da impostare per il ritardo. Una volta visualizzato il numero di giorni desiderato, riportare il selettore in posizione **ACCESO** per attivare il ritardo.

Per modificare l'impostazione relativa ai giorni di ritardo esistente:

1. Aprire il menu Ritardo Solar Sync premendo il pulsante **+** e ruotando il selettore su Impostazioni Solar Sync, quindi rilasciando il pulsante **+**.
2. Utilizzare i tasti **+ o -** per modificare il numero di giorni fino alla visualizzazione dei giorni di ritardo desiderati. (Se i giorni vengono impostati su **00**, il ritardo Solar Sync viene impostato su **OFF**).
3. Riportare il selettore in posizione **ACCESO** per applicare le modifiche.

Quando il ritardo Solar Sync è attivo, Solar Sync continua a raccogliere le informazioni climatiche e a calcolare il valore di regolazione stagionale. La regolazione stagionale verrà applicata quando il ritardo Solar Sync raggiunge **00**.



NOTA: il numero di giorni rimanenti non viene visualizzato nella schermata **ACCESO**. Per verificare se la funzione Ritardo sia attiva, aprire il menu Ritardo Solar Sync e controllare i giorni visualizzati. Se sono visualizzati uno o più giorni, la funzione Ritardo Solar Sync è attiva, se si visualizza **00**, la funzione Ritardo Solar Sync non è attiva.

CONNESSIONE A UN TELECOMANDO HUNTER

Connessione a un telecomando Hunter (non incluso)

Il programmatore X-Core è ora compatibile con i telecomandi Hunter (non inclusi). Il fascio di cavi SmartPort (fornito con tutti i telecomandi Hunter) consente un uso rapido e semplice dei telecomandi Hunter. I telecomandi Hunter consentono di azionare il sistema senza recarsi ogni volta presso il programmatore.

Per installare il collegamento del Porto Smart®

1. Installare un raccordo a "T" con filettatura femmina da 13 mm nella centralina di cablaggio sotto il programmatore X-Core (non inclusa) a circa 30 cm di distanza.
2. Infilare i cavi rosso, bianco e blu del fascio di cavi base del raccordo a "T" e nel vano di cablaggio del programmatore, seguendo l'illustrazione.

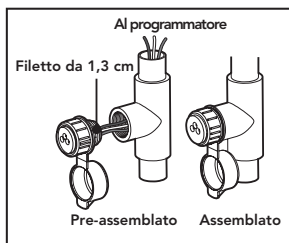

3. Avvitare l'alloggiamento del fascio di cavi SmartPort al raccordo a "T", come illustrato.
4. Collegare i cavi rosso, bianco e blu di SmartPort ai terminali del programmatore, come illustrato di seguito:
 - Cavo rosso sul terminale sinistro "24VAC"
 - Cavo bianco sul terminale destro "24VAC"
 - Cavo blu sul terminale "REM"

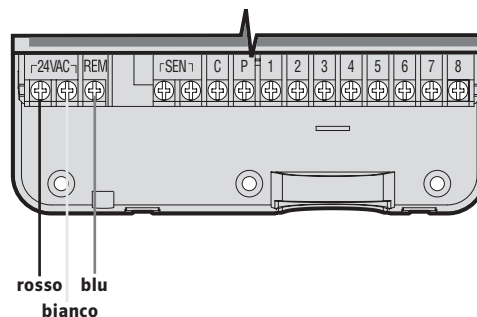

NOTA: PN 258200 può essere utilizzato come metodo alternativo per l'installazione del connettore SmartPort.

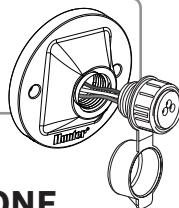

INTERRUZIONI DI ALIMENTAZIONE



In considerazione dei rischi di interruzione dell'alimentazione elettrica, il programmatore ha una memoria non volatile. In tal modo nessuna delle informazioni programmate potrà mai essere perduta. La batteria al litio fornirà il giorno e l'ora corretti senza necessità dell'alimentazione CA. Il normale programma d'irrigazione riprenderà al ripristino dell'alimentazione elettrica CA.

PROGRAMMAZIONE DEL PROGRAMMATORE

Quando il programmatore non è in funzione, il display dell'XC indica l'ora e il giorno. La visualizzazione dei dati si modifica ruotando il selettore girevole per inserire le informazioni specifiche di programmazione. Per modificare la parte del display che lampeggia durante la programmazione, usare i tasti **+** o **-**. Per modificare invece le informazioni che non lampeggiano, premere il tasto **◀** o **▶** fino a quando non si vedrà lampeggiare la zona desiderata.

Ognuno dei programmi A, B e C può accettare 4 avvii di ciclo al giorno; in questo modo il programmatore risponde ad esigenze d'irrigazione diverse usando programmi d'irrigazione diversi.

Regolazione di giorno e ora ⌚

1. Portare il selettore rotativo in posizione REGOLAZIONE GIORNO/ORA.
2. L'anno corrente lampeggia. Premere i tasti **+** o **-** per modificare l'anno. Dopo aver impostato l'anno, premere il tasto **▶** per impostare il mese.
3. Il mese e il giorno saranno visualizzati sul display. Il mese lampeggerà e l'icona  sarà visualizzata. Premere i tasti **+** o **-** per modificare il mese. Premere il tasto **▶** per impostare il giorno.
4. Il giorno lampeggerà e l'icona  sarà visualizzata. Premere i tasti **+** o **-** per modificare il giorno. Premere il tasto **▶** per impostare l'ora.
5. Verrà visualizzata l'ora. Usare i tasti **+** e **-** per selezionare AM, PM, o 24 ore. Premere il tasto **▶** per regolare l'ora. Il numero relativo all'ora lampeggerà. Usare i tasti **+** e **-** per modificare l'ora indicata sul display. Premere il tasto **▶** per regolare i minuti. Il numero relativo ai minuti lampeggerà. Usare i tasti **+** e **-** per modificare i minuti indicati sul display. La programmazione della data, del giorno e dell'ora è terminata.



NOTA: in fase di programmazione è bene sapere che il simbolo o il carattere che lampeggia è l'elemento da programmare. Per esempio, se l'ora lampeggia mentre si stanno regolando il giorno e l'ora, si potrà modificare o programmare l'ora. Per maggiore chiarezza, in questo manuale i caratteri lampeggianti appaiono in GRIGIO.

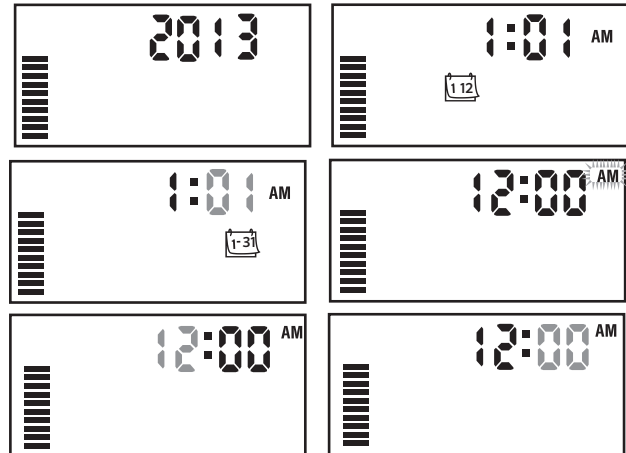
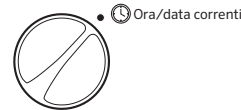

PROGRAMMAZIONE DEL PROGRAMMATORE

Regolazione degli orari di partenza dei programmi

1. Portare il selettore in posizione **REGOLAZIONE PARTENZE.**
2. La preimpostazione di fabbrica è sul programma A. Se necessario, è possibile selezionare il programma B o C premendo il tasto **PRG**.
3. Premere i tasti **+** o **-** per modificare il tempo di avvio (con incrementi di 15 minuti).
4. Premere il tasto **▶** per aggiungere un ulteriore tempo di avvio, oppure il tasto **PRG** per passare al programma successivo.

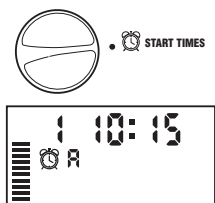

NOTA: la scelta di un tempo di avvio fa partire la sequenza d'irrigazione di tutte le stazioni. Pertanto è inutile programmare una partenza per ogni stazione. I tempi di avvio multipli di un programma possono essere usati per cicli d'irrigazione distinti la mattina, il pomeriggio o la sera. Le partenze possono essere inserite in qualsiasi ordine. L'X-Core li ordinerà in modo automatico.

Cancellazione di una partenza programmata

Portare il selettore in posizione **REGOLAZIONE PARTENZE** e premere il tasto **+** o **-** fino a visualizzare 12:00 AM (mezzanotte). Da qui, premere una volta il tasto **-** per visualizzare l'indicazione OFF. Premere la freccia destra per eliminare un secondo orario di avvio.

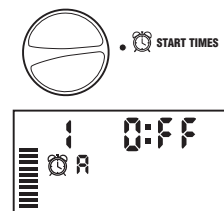



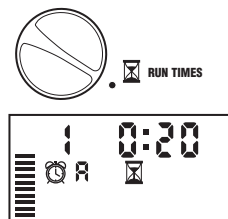

Regolazione dei tempi d'irrigazione

1. Portare il selettore in posizione **REGOLAZIONE TEMPI D'IRRIGAZIONE.**
2. Il display indica l'ultimo programma selezionato (A, B o C), il numero della stazione selezionata, l'icona ; la stazione lampeggerà. Usare il tasto **PRG** per passare a un altro programma.
3. Usare i tasti **+** o **-** per modificare il tempo d'irrigazione della stazione sul display. È possibile regolare i tempi d'irrigazione da 0 a 4 ore.
4. Premere il tasto **▶** per passare alla stazione successiva.





Regolazione dei giorni d'irrigazione

1. Portare il quadrante in posizione **REGOLAZIONE GIORNI D'IRRIGAZIONE.**
2. Il display indica l'ultimo programma selezionato (A, B o C). Usare il tasto **PRG** per passare a un altro programma.
3. Il programmatore visualizzerà i sette giorni della settimana MO, TU, WE, TH, FR, SA, SU (MO = LUN, TU = MAR, WE = MER, TH = GIOV, FR = VEN, SA = SAB, SU = DOM). Ogni giorno sarà contraddistinto da un'icona  o  disposta sopra. L'icona  rappresenterà un giorno della settimana con irrigazione, mentre l'icona  rappresenterà un giorno senza irrigazione.





PROGRAMMAZIONE DEL PROGRAMMATORE

Selezione di giorni specifici della settimana





1. Con il cursore  puntato su un giorno specifico (il cursore parte sempre da MO (= LUN), premere il tasto  per selezionare un giorno particolare d'irrigazione. Premere il tasto  per cancellare l'irrigazione di quel giorno. Dopo aver premuto un tasto, il cursore passa automaticamente al giorno seguente.



2. Ripetere l'operazione fino ad aver selezionato tutti i giorni scelti. Ogni giorno selezionato è indicato dall'icona , che sta indicare che è attivo. L'ultima icona  corrisponde all'ultimo giorno d'irrigazione del programma.

Selezione dei giorni pari/dispari per l'irrigazione

Questa funzione usa i giorni numerati del mese per l'irrigazione invece che giorni specifici della settimana (giorni dispari: 1, 3, 5 ecc; giorni pari: 2, 4, 6, ecc.).



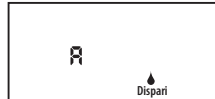

1. Premere la freccia destra  finché il cursore passa a SU.
2. Premere di nuovo la freccia destra. Verrà visualizzato DISPARI, con l'icona della goccia di pioggia]. Se si desidera impostare DISPARI, ruotare di nuovo il selettore in posizione Acceso.
3. Se si desidera effettuare l'irrigazione in giorni pari, premere una sola volta il pulsante . Verranno visualizzati l'icona e  e PARI. È possibile passare da DISPARI a PARI e vice-versa premendo i pulsanti .



NOTA: il 31 di ogni mese e il 29 febbraio sono sempre giorni di non irrigazione, se è selezionata l'irrigazione nei giorni DISPARI (ODD).

Selezione degli intervalli d'irrigazione

Con questa opzione si può impostare l'intervallo tra le irrigazioni da 1 a 31 giorni.

1. Con il cursore su EVEN (PARI), premere una volta il tasto  ed apparirà l'icona  insieme al numero 1 lampeggiante. Sul display appare l'intervallo tra le irrigazioni.
2. Usare i tasti  o  per selezionare il numero di giorni tra un giorno d'irrigazione e l'altro (da 1 a 31). Questo sarà il periodo di intervallo tra le irrigazioni.



Il programmatore irrigherà secondo il programma scelto non appena raggiungerà un orario di partenza impostato secondo l'intervallo selezionato.



Nota: per uscire dalla modalità intervallo (se non desiderata), premere il pulsante freccia sinistra fino a visualizzare di nuovo la schermata Giorno della settimana.

Regolazione del/i giorno/i di non irrigazione

L'X-Core consente di programmare uno o più giorni di non irrigazione. Questa funzione è utile quando si desidera bloccare l'irrigazione in uno o in più giorni specifici. Ad esempio, se si taglia l'erba sempre di sabato, il sabato sarà un giorno di Non irrigazione, in modo da consentirvi di tagliare il prato senza che sia bagnato.

1. Portare il quadrante in posizione REGOLAZIONE GIORNI D'IRRIGAZIONE.

PROGRAMMAZIONE DEL PROGRAMMATORE

- Inserire un programma di intervallo tra irrigazioni come descritto a pagina 21.
- Premere il tasto ► per scorrere fino a Giorni di non irrigazione in fondo al display. MO (= LUN) lampeggerà.
- Usare il tasto ► fino a quando il cursore arriva sul giorno della settimana in cui si desidera impostare Giorno di non irrigazione.
- Premere il tasto ■ per impostare il giorno scelto come giorno di non irrigazione. L'icona ☉ si illuminerà sul giorno scelto.
- Ripetere i passaggi 4 e 5 fino a quando tutti i giorni di non irrigazione sono stati selezionati.



NOTA: è possibile anche programmare i giorni di non irrigazione pari e dispari

Funzionamento automatico

Dopo aver programmato l'X-Core, impostare il selettore su ACCESO per consentire l'esecuzione automatica di tutti i programmi d'irrigazione e tempi di avvio selezionati.



Arresto dell'impianto

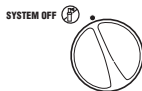

Portare il selettore in posizione SPENTO. Le valvole aperte vengono chiuse entro i successivi due secondi. Tutti i programmi attivi sono disattivati e l'irrigazione viene bloccata. Per riportare il programmatore in modo automatico normale, basterà riportare il selettore in posizione ACCESO.



Spegnimento sistema d'irrigazione programmabile

Si tratta di una funzione che consente all'utente di interrompere tutti i programmi d'irrigazione programmati per un determinato periodo, compreso tra 1 e 7 giorni. Al termine del periodo programmato di assenza d'irrigazione, il programmatore riprenderà il normale funzionamento automatico.



- Portare il quadrante in posizione SPENTO. Attendere che **OFF** venga visualizzato.
- Premere ► la quantità di volte necessaria per impostare il numero di giorni desiderato (fino ad un massimo di 7).
- Riportare il selettore in posizione **ACCESO**. Saranno allora visualizzate le icone **OFF**,  e  un numero.



I giorni di inattività del sistema



decresteranno ogni giorno (con passaggio da un giorno all'altro alle ore 00:00). Raggiunto lo zero, il display mostrerà l'ora del giorno corrente e riprenderà normalmente l'irrigazione secondo i tempi di avvio previsti dal sistema.

Regolazione stagionale %

La regolazione stagionale viene usata per modificare globalmente i tempi d'irrigazione senza dover ritoccare la programmazione. Per usare questa funzione:



PROGRAMMAZIONE DEL PROGRAMMATORE

1. Portare il selettore in posizione **REGOLAZIONE STAGIONALE**.
2. Sul display si osserva un numero che lampeggia seguito dal simbolo di percentuale % ed una scala sempre visibile. Premere il tasto  o  per regolare la percentuale di regolazione stagionale. Ogni riga sul grafico rappresenta il 10%. Questa funzione consente di selezionare una percentuale compresa tra il 10% e il 150% del programma originale.

Per visualizzare i nuovi tempi d'irrigazione, basterà ruotare il selettore su TEMPI D'IRRIGAZIONE. Il display del tempo d'irrigazione terrà conto della regolazione stagionale.







NOTA: la programmazione iniziale deve sempre essere effettuata in posizione 100%.

Quando si utilizza un sensore “Klik” Hunter, la regolazione stagionale può essere impostata come descritto.









Se si utilizza un sensore ET Solar Sync, il valore di regolazione stagionale viene aggiornato automaticamente in base al regime climatico ricevuto dal sensore Solar Sync. Tale valore può essere ignorato manualmente premendo i pulsanti  o  fino a raggiungere il valore di regolazione stagionale desiderato. Tuttavia, è importante tenere presente che il valore di regolazione stagionale impostato manualmente verrà sostituito a partire dalla mezzanotte dal nuovo valore aggiornato del sensore Solar Sync. **Il sensore ET Solar Sync misura i regimi climatica, determina il valore di regolazione stagionale ottimale, quindi aggiorna il programmatore su base giornaliera.**

Avvio manuale di una sola stazione

1. Portare il selettore in posizione **FUNZIONAMENTO MANUALE - UNA STAZIONE**. 
2. Il tempo d'irrigazione della stazione lampeggia; usare il tasto  per passare alla stazione desiderata. Per selezionare la durata d'irrigazione di una stazione, usare i tasti  o .
3. Portare il selettore in posizione **ACCESO** ruotandolo in senso orario (solo la stazione indicata irrigherà, il programmatore ripasserà quindi alla modalità automatica senza che il programma selezionato in precedenza venga modificato). Vedere anche Avvio manuale **One Touch e avanzamento**.

Avvio manuale One Touch e avanzamento







Si possono attivare tutte le stazioni d'irrigazione senza usare il selettore.

1. Tenere premuto il tasto  per due secondi.
2. Questa funzione passa automaticamente al programma A. Si può selezionare il programma B o C premendo il tasto .
3. Il numero della stazione lampeggia. Usare il tasto  per far scorrere le stazioni e i tasti  o  per regolare i tempi d'irrigazione delle stazioni (se non si esercita pressione sui tasti per qualche secondo durante i passaggi 2 o 3, il programmatore inizierà automaticamente ad irrigare).
4. Premere il tasto  per spostarsi sulla stazione dalla quale si desidera iniziare. Dopo 2 secondi il programma parte. In qualsiasi momento durante il ciclo manuale, si possono usare i tasti  o  per passare manualmente da una stazione all'altra.

FUNZIONALITÀ AVANZATE



Esclusione programmabile del sensore

L'X-Core consente all'utente di programmare il programmatore in modo tale che il sensore blocchi l'irrigazione solo sulle stazioni desiderate. Ad esempio, i giardini con piante o parti di prato sotto gronda possono avere necessità di essere irrigati anche nei periodi di pioggia. Per programmare l'esclusione di un sensore:

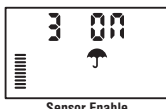
1. Portare il selettore in posizione **ACCESO**.
2. Premere e tenere premuto il tasto  mentre si ruota il selettore su **REGOLAZIONE PARTENZE**.
3. Rilasciare il pulsante . A questo punto, il display mostrerà il numero di stazione, ON e l'icona  lampeggerà.
4. Premere il tasto  o  per attivare o disattivare il sensore per la stazione indicata.
ON = Sensore attivato (l'irrigazione verrà sospesa)
OFF = Sensore disattivato (l'irrigazione sarà attiva)
5. Usare i tasti  o  per passare alla stazione successiva per cui si desidera programmare l'esclusione del sensore.





NOTA: Il sensore è preimpostato per disattivare tutte le zone in caso di pioggia.

Quando l'X-Core riceve un input dal sensore per disattivare l'irrigazione, il display indica le stazioni che sono state programmate per escludere il sensore. La stazione funzionante in modalità di esclusione del sensore avrà le icone  e  lampeggianti alternativamente.





Programma di verifica di tutte le stazioni

L'X-Core consente all'utente di utilizzare un metodo semplificato per effettuare un programma di verifica. Questa funzione sarà applicata su tutte le stazioni in sequenza numerica, dal numero più basso a quello più alto.

1. Con il selettore in posizione **ACCESO**, premere e tenere premuto il pulsante . Verrà visualizzato il numero di stazione e l'ora lampeggerà per due secondi.
2. Usare i tasti  o  per impostare i tempi d'irrigazione da 1 a 15 minuti. Il tempo d'irrigazione deve essere inserito una sola volta.
3. Dopo 2 secondi di pausa, il programma di verifica parte.

Diagnostica Hunter Quick Check

Questa funzione consente di diagnosticare velocemente eventuali problemi di collegamento con il programmatore. Invece di dover controllare ogni circuito di collegamento sul campo per trovare il problema, si può usare la procedura di verifica dei circuiti Hunter Quick Check. Per attivare la procedura di verifica Quick Check:

1. Premere i tasti , , , e  contemporaneamente. In modalità stand-by, lo schermo LCD mostrerà tutti i segmenti.
2. Premere una volta il tasto  per avviare la procedura di verifica Quick Check. In pochi secondi, il sistema fa una ricerca su tutte le stazioni per rilevare eventuali problemi sui circuiti. Quando viene rilevato un problema su un punto del sistema, il display mostra momentaneamente un simbolo lampeggiante ERR preceduto dal numero della stazione corrispondente. Dopo che il Quick Check di Hunter termina la verifica di diagnosi del circuito, il programmatore torna in modalità d'irrigazione automatica.

FUNZIONALITÀ AVANZATE

Memorizzazione di un programma Easy Retrieve™

L'X-Core è in grado di salvare il programma d'irrigazione preferito in memoria, affinché possa essere recuperato successivamente. Questa funzione consente di resettare il programmatore in modo rapido riportandolo al programma d'irrigazione originario.

Salvataggio del programma in memoria.

1. Con il selettore in posizione ACCESO, premere e tenere premuti i tasti **+** e **PRG** per 5 secondi. Il display visualizzerà in scorrimento tre segmenti **≡** da sinistra a destra, ad indicare che è in corso il salvataggio del programma in memoria.
2. Rilasciare i tasti **+** e **PRG**.

Recupero di un programma salvato in memoria.

1. Con il selettore in posizione ACCESO, premere e tenere premuti i tasti **-** e **PRG** per 5 secondi. Il display visualizzerà in scorrimento tre segmenti **≡** da destra a sinistra, ad indicare che è in corso il salvataggio del programma in memoria.
2. Rilasciare i tasti **-** e **PRG**.

Ritardo programmabile tra le stazioni

Si tratta di una funzione che consente all'utente di inserire un ritardo tra le stazioni tra lo spegnimento di una determinata stazione e l'avvio di quella successiva.

1. Iniziare con il quadrante in posizione ACCESO.

2. Premere e tenere premuto il tasto **≡** mentre si ruota il selettore su **REGOLAZIONE TEMPI D'IRRIGAZIONE**.
3. Rilasciare il pulsante **≡**. A questo punto il display mostrerà un tempo di ritardo per tutte le stazioni in secondi (lampeggiante).
4. Premere il pulsante **+** o **-** per aumentare o diminuire il tempo di ritardo in un periodo compreso tra 0 secondi e 4 ore.
5. Riportare il selettore in posizione ACCESO.

Azzeramento della memoria/reset del programmatore

Se si ha la sensazione di aver impostato il programmatore in modo non corretto, esiste una procedura che consente di resettare la memoria secondo le impostazioni di fabbrica e di cancellare tutti i programmi e i dati inseriti nel programmatore.

1. Premere e tenere premuto il pulsante **PRG**.
2. Tenendo premuto il pulsante **PRG**, premere e rilasciare il pulsante sul lato destro del programmatore.
3. Continuare a tenere premuto il pulsante **PRG** finché non si visualizzano le ore 12:00 (l'operazione richiede circa 8 secondi).

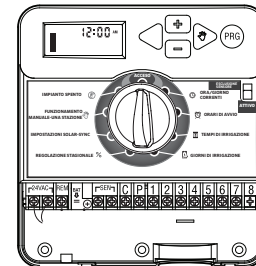

Reset (Reimposta)

RITARDO CLIK: ISTRUZIONI

Funzione Ritardo Klik

Questa funzione consente di ritardare le irrigazioni programmate per un periodo prestabilito (compreso tra 1 e 7 giorni) AL TERMINE di un evento Klik. Al termine del periodo di ritardo Klik programmato, il programmatore ripristinerà la normale irrigazione automatica.

1. Spostare il selettore in posizione **ACCESO**
2. Premere e tenere premuto il pulsante **+** per 3 secondi, quindi ruotare il selettore in posizione **OFF**
3. Rilasciare il pulsante **+**. Sul display verrà visualizzato il ritardo Klik programmabile.



4. Premere il pulsante **+** per impostare il ritardo Klik (compreso tra 1 e 7 giorni).
5. Spostare il selettore in posizione **ACCESO**. A questo punto, il ritardo Klik è impostato.

Al termine di un evento Klik (il sensore pioggia passa da umido a secco), la funzione Ritardo Klik diventa attiva sul display viene mostrata la durata del ritardo Klik. Il conto alla rovescia dei giorni verrà attivato 24 ore dopo l'avvio del ritardo Klik.



Per annullare un ritardo Klik attivo, spostare il selettore in posizione **OFF**, attendere che OFF smetta di lampeggiare, quindi riportare il selettore in posizione **ACCESO**.

Le eventuali stazioni impostate in modo da escludere il sensore, nonché i programmi di illuminazione, funzioneranno durante un evento Ritardo Klik.



NOTA: prestare attenzione quando si utilizza la funzione Ritardo Klik programmabile con Hunter Wind-Klik®, Freeze-Klik®, Soil-Klik e il componente di gelo di Solar Sync e Rain/Freeze Klik poiché il ritardo Klik verrà attivato DOPO l'evento Klik da tali dispositivi.

FUNZIONI NASCOSTE

Personalizzazione dei programmi

Il programmatore X-Core è configurato in fabbrica con tre programmi indipendenti (**A, B, C**) con quattro partenze, per soddisfare le differenti caratteristiche di ogni impianto. Il programmatore X-Core può essere personalizzato per mostrare un solo programma ed una sola partenza, nascondendo i programmi e le partenze inutilizzate per semplificare la programmazione.

1. Iniziate con il selettore in posizione **ACCESO**.
2. Mentre tenete premuto il tasto - girate il selettore sulla posizione **GIORNI DI IRRIGAZIONE**.
3. Rilasciate il tasto -.
4. Utilizzate i tasti + e - per cambiare la modalità di programmazione.

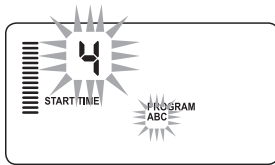

Modalità normale
(3 programmi / 4 partenze)

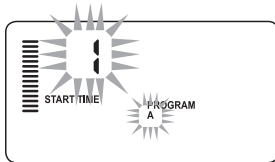

Modalità limitata
(1 programma / 1 partenza)

FUNZIONI NASCOSTE (CONTINUA)

Ciclo e assorbimento

La funzione Ciclo e assorbimento consente di suddividere il tempo d'irrigazione di una stazione in periodi di irrigazione più brevi. Questa funzione è utile per le irrigazioni su pendii, terreni poco permeabili o zone appena seminate dato che applica l'acqua più frequentemente ma per meno tempo, evitando così ruscellamento o allagamenti. Inserire la durata del ciclo desiderato per la stazione e il periodo di assorbimento inteso come numero minimo di minuti di attesa necessari prima che si possa effettuare il secondo ciclo. Il numero totale di cicli impostati si ottiene dividendo il tempo di irrigazione totale impostato per la durata prescelta del ciclo.

Accesso al menu Ciclo e assorbimento:

Per accedere alla funzione Ciclo e assorbimento, ruotare il selettore in posizione **ACCESO**, premere e tenere premuto il pulsante **+** per 3 secondi; quando si tiene premuto il pulsante **+**, ruotare il selettore in posizione **TEMPI D'IRRIGAZIONE**, quindi rilasciare il pulsante.



Esempio di schermata Ciclo pronta per l'immissione dei dati



Esempio di schermata Ciclo solo con minuti



Esempio di schermata Ciclo con ore incluse

Impostazione della durata del ciclo:

Inizialmente, viene visualizzata la stazione 1. Per accedere alle altre stazioni, premere il pulsante ◀▶.

Una volta visualizzata la stazione desiderata, utilizzare il pulsante **+** o **-** per aumentare o diminuire la durata del ciclo. È possibile impostare la durata da 1 minuto fino a 4 ore in incrementi di 1 minuto o su **OFF** se non si desidera impostare alcun ciclo.



NOTA: prima di visualizzare 1 ora, vengono visualizzati solo i minuti (ad esempio 36).

Da 1 ora in su, viene visualizzato l'orario in ore e minuti (ad esempio 1:13 e 4:00).

Se i tempi d'irrigazione sono pari o inferiori alla durata del ciclo, non viene applicato alcun ciclo.

FUNZIONI NASCOSTE (CONTINUA)

Accesso al menu Assorbimento:

Dopo aver programmato le durate dei cicli desiderate, è possibile accedere alla durata dell'assorbimento premendo il pulsante **PRG**.

La stazione sarà identica a quella mostrata in precedenza impostando il ciclo (ovvero, se nel menu Ciclo viene visualizzata la stazione 2, tale stazione verrà visualizzata per impostarne l'assorbimento premendo il pulsante **PRG**).



NOTA: non è possibile accedere al menu Assorbimento senza prima aver programmato una durata del ciclo.

Impostazione della durata dell'assorbimento:

Per accedere alle altre stazioni, premere il pulsante ◀▶.



NOTA: quando si cambiano le stazioni, se si individua una stazione a cui non è associata una durata del ciclo, la schermata tornerà alla durata del ciclo. Passare alla stazione successiva con una durata del ciclo, quindi premere il pulsante **PRG** per tornare al menu assorbimento.

Una volta visualizzata la stazione desiderata, utilizzare il pulsante **+** o **-** per aumentare o diminuire la durata dell'assorbimento. È possibile impostare la durata dell'assorbimento da 1 minuto fino a 4 ore in incrementi di 1 minuto.



NOTA: prima di visualizzare 1 ora, vengono visualizzati solo i minuti (ad esempio 36). Da 1 ora in su, viene visualizzato l'orario in ore e minuti (ad esempio 1:13 e 4:00).

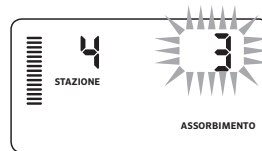

Esempio di schermata Assorbimento solo con minuti

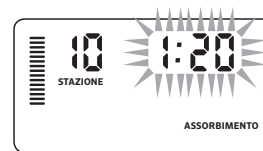

Esempio di schermata Assorbimento con ore incluse

Situazioni di ciclo e assorbimento





La stazione 1 necessita di 20 minuti di irrigazione, ma dopo 5 minuti avviene il ruscellamento. Dopo appena 10 minuti però il terreno è pronto per assorbire più acqua. La soluzione sarebbe quella di programmare 20 minuti come tempo d'irrigazione della stazione, 5 minuti come tempo del ciclo e 10 minuti come tempo di assorbimento.

La durata dell'assorbimento è una quantità minima. Tale durata può essere più lunga in base ai tempi d'irrigazione rimanenti.



Esecuzione del ciclo della stazione 10

GUIDA ALLA RISOLUZIONE DEI PROBLEMI

Problema	Cause	Soluzioni
Il programmatore irriga continuamente	Sono state programmate troppe partenze di ciclo	È necessaria una sola partenza per attivare un programma, (fare riferimento a Impostazione dei tempi di avvio a pagina 18)
Sul display non appare nessuna informazione	Controllare il collegamento all'alimentazione AC	Correggere eventuali errori
Il display mostra "No AC"	Non vi è alimentazione AC (il programmatore non è alimentato)	Controllare che il trasformatore sia installato correttamente
Il display mostra "Off,  ,  <td>Il sensore pioggia sta interrompendo l'irrigazione o è stato rimosso il ponticello tra le morsettiere contrassegnate con SEN</td> <td>Portare l'interruttore di esclusione del sensore pioggia su BYPASS per bypassare il circuito del sensore pioggia, oppure reinstallare il ponticello</td>	Il sensore pioggia sta interrompendo l'irrigazione o è stato rimosso il ponticello tra le morsettiere contrassegnate con SEN	Portare l'interruttore di esclusione del sensore pioggia su BYPASS per bypassare il circuito del sensore pioggia, oppure reinstallare il ponticello
Il sensore pioggia non arresta il sistema	<ul style="list-style-type: none"> • Sensore pioggia difettoso • Il ponticello non è stato rimosso durante l'installazione del sensore • Le stazioni sono state programmate per escludere il sensore 	<ul style="list-style-type: none"> • Verificare il funzionamento del sensore pioggia e la corretta cablatura dell'impianto • Rimuovere il ponticello dai terminali del sensore • Riprogrammare l'esclusione del sensore per attivarlo (vedere pagina 11)
Il display è bloccato o mostra informazioni non corrette	Picco di alimentazione	Resettare il programmatore come indicato a pagina 24 "Azzeramento della memoria /reset del programmatore"
Il display mostra "ERR" seguito da un numero (1-8)	Corto circuito nei cavi verso la valvola o solenoide difettoso sul numero di stazione indicato	Controllare il cablaggio e riparare il corto circuito o sostituire il solenoide della stazione indicata. Premere un tasto qualsiasi per cancellare il messaggio "ERR" dal display
Il display mostra "P ERR"	<ul style="list-style-type: none"> • Relè pompa o valvola principale difettosi • Relè pompa o solenoide difettoso o incompatibile • Cablaggio non sufficiente per relè pompa o valvola principale 	<ul style="list-style-type: none"> • Verificare la connessione al relè o al solenoide della valvola principale. Premere un tasto qualsiasi per cancellare "P ERR" dal display • Controllare le specifiche tecniche del relè pompa. Non superare i valori elettrici specificati per il programmatore. Sostituire se difettoso • Sostituire il cavo con uno di calibro maggiore
Il display mostra una stazione funzionante ma le icone  e  lampeggiano.	Il sensore sta bloccando l'irrigazione; la stazione però è stata programmata per escludere il sensore	Controllare lo stato di esclusione del sensore (vedere pagina 23)

GUIDA ALLA RISOLUZIONE DEI PROBLEMI

Problema	Cause	Soluzioni
L'irrigazione automatica non parte all'avvio del ciclo e il programmatore non è spento	<ul style="list-style-type: none"> • L'ora AM/PM del giorno non è stata inserita correttamente • L'ora AM/PM della partenza non è stata inserita correttamente • Il tempo di partenza è disattivato (su Off) • Il programmatore non riceve alimentazione CA 	<p>Correggere l'ora AM/PM del giorno</p> <p>Correggere l'ora AM/PM della partenza</p> <p>Vedere Regolazione dei tempi di partenza dei programmi (pag. 18)</p> <p>Controllare i collegamenti dell'alimentazione CA</p>
Sul display vengono visualizzati dei trattini quando il selettore si trova nella posizione "Imp. Solar Sync"	<ul style="list-style-type: none"> • Il sensore Solar Sync non è collegato al programmatore • I cavi del sensore Solar Sync potrebbero non essere stati collegati correttamente 	<p>Connectez le capteur Solar Sync sur les repères « SEN » du bornier. L'affichage présente alors les paramètres correspondant à la région et au réglage du débit</p>
I tempi di esecuzione di una particolare stazione sono troppo brevi/lunghi	<p>Il tempo di esecuzione del programma è troppo breve/lungo</p>	<p>Il sensore Solar Sync fornisce al programmatore una regolazione stagionale globale. Se una particolare stazione presenta tempi di esecuzione troppo brevi o troppo lunghi, apportare le regolazioni appropriate al programma all'interno del programmatore. Accertarsi di riportare la regolazione stagionale su 100% prima di modificare i tempi di esecuzione di un programma. Per farlo, ruotare il selettore nella posizione "Regolazione stagionale", quindi incrementare/ridurre il valore fino a 100%</p>
Regolazione stagionale bassa	<p>Ambiente troppo alto</p> <p>Impostazione di regolazione dell'acqua troppo bassa La posizione del sensore non consente l'esposizione in pieno sole</p>	<p>Aumentate il valore per la regolazione dell'acqua (l'impostazione predefinita è 5) Se impostate la regolazione dell'acqua sul valore massimo 10 ed occorre ancora intervenire sulle regolazioni stagionali, spostate la regolazione ambientale su un livello più basso, ad esempio da 4 a 3, e partite impostando la regolazione dell'acqua su 5. Solar Sync aggiorna immediatamente la regolazione stagionale sul programmatore. Se risulta ancora insufficiente, ripetete la regolazione fino a che sul programmatore non viene mostrata la regolazione stagionale desiderata</p>

GUIDA ALLA RISOLUZIONE DEI PROBLEMI

Problema	Cause	Soluzioni
Il valore di regolazione stagionale sembra troppo alto	<ul style="list-style-type: none"> • Valore regione troppo basso • Impostazione di regolazione dell'irrigazione troppo elevata 	Ridurre il valore di regolazione dell'irrigazione. Se una volta raggiunto il valore minimo di regolazione dell'irrigazione di 1 la regolazione stagionale è ancora troppo elevata, aumentare il valore relativo alla regione (da 2 a 3, ad esempio) e iniziare a impostare la regolazione dell'irrigazione su 5. Il sensore Solar Sync aggiornerà immediatamente il valore di regolazione stagionale sul programmatore. Se tale valore è ancora troppo alto, ripetere la regolazione dell'irrigazione fino a quando sul programmatore non appare la regolazione stagionale desiderata
Solar Sync continua a inviare le regolazioni stagionali quando l'interruttore di bypass del programmatore viene spostato nella posizione "Bypass"	La regolazione stagionale automatica di Solar Sync non può essere disattivata dall'interruttore di bypass. L'interruttore di bypass controlla solo la funzione di spegnimento per pioggia/freddo intenso di Solar Sync	
Dopo aver rimosso il sensore Solar Sync dal programmatore, non è possibile modificare manualmente il valore di regolazione stagionale	Il sensore Solar Sync deve essere disinstallato se rimosso in modo permanente dal programmatore	Dopo aver rimosso il sensore Solar Sync dal programmatore, ruotare la manopola su "Imp. Solar Sync". Sul display vengono visualizzate delle linee tratteggiate. A questo punto il sensore è disinstallato
Il display indica "no SS"	<ul style="list-style-type: none"> • Il sensore Solar Sync è stato scollegato dal controller ma non è stato disinstallato • La connessione di Solar Sync è difettosa 	<ul style="list-style-type: none"> • Verificare il cablaggio del sensore Solar Sync verso il controller • Disinstallare il sensore Solar Sync se si intende rimuovere in modo permanente il sensore dal controller (vedere pagina 14)

SPECIFICHE

Specifiche di funzionamento

- Tempi di funzionamento delle stazioni: da 0 minuti a 4 ore (con incrementi di 1 minuto)
- 3 programmi d'irrigazione indipendenti
- Partenze: 4 al giorno, a programma (fino a 12 avvii giornalieri)
- Programmazione dell'irrigazione: calendario da 365 giorni, irrigazione con intervalli, irrigazione giorni pari/dispari
- Orologio AM/PM o 24 ore
- Funzionamento manuale semplice
- Esclusione sensore per stazione
- Ritardo pioggia programmabile (da 1 a 7 giorni)
- Regolazione stagionale (dal 10% al 150%)
- Interruttore di esclusione sensore
- XC-x00i Uso per interni
- XC-x00 Uso per esterni
- Dal livello del mare fino a 2000 m tra 0°C-50°C

Dimensioni

Armadietto per interni

- Altezza: 16,5 cm
- Larghezza: 14,6 cm
- Profondità: 5 cm

Armadietto per esterni

- Altezza: 22 cm
- Larghezza: 17,8 cm
- Profondità: 9,5 cm

Specifiche elettriche

- Ingresso trasformatore 120VAC \pm 10% 60 Hz (230VAC \pm 10% 50/60 Hz modelli internazionali)
- Uscita trasformatore: 24VAC 1,0 A
- Uscita stazione: 0,56 A per stazione
- Uscita massima: 0,90 A (compresa valvola principale)
- Batteria: 3V al litio (compresa nella fornitura), per programmazione in remoto e timer di backup. CR2032 3-volt
- Protezione da corto circuito elettron
- Memoria permanente per i dati di programma
- In attesa di approvazione CE
- Il modello XC-x00 ha un coefficiente IP24 per il grado 4 di inquinamento
- Pulire solo con un panno umidificato con sapone neutro e acqua

Legenda











~ = CA

 = Documenti di consultazione







 = Voltaggi Pericolosi

 = Terra

ÍNDICE

COMPONENTES DO X-CORE	2
INSTALAÇÃO DO CONTROLADOR NA PAREDE	6
CONEXÃO DAS VÁLVULAS E DO TRANSFORMADOR	7
ATIVAÇÃO DA BATERIA	8
SUBSTITUIÇÃO DA BATERIA	8
CONEXÃO DE UMA VÁLVULA MESTRE	9
CONEXÃO DE UM RELÉ DE PARTIDA DA BOMBA	10
CONEXÃO DE UM SENSOR METEOROLÓGICO "CLIK" DA HUNTER	11
Teste do sensor meteorológico	11
Supressão manual do sensor meteorológico	11
CONEXÃO DE UM SENSOR ET SOLAR SYNC DA HUNTER	12
Instalação do sensor Solar Sync	12
Instalação do Solar Sync® sem fio	12
Configurações do Solar Sync	12
Região 	13
Ajuste da rega 	14
Desinstalação de um sensor Solar Sync	14
Calibração/Configuração	15
FUNÇÃO DE ESPERA DO SOLAR SYNC	16
Espera do Solar Sync para o X-CORE®	16
CONEXÃO A UM CONTROLE REMOTO HUNTER	17
Conexão a um controle remoto Hunter (não incluído)	17
Instalação do conector SmartPort	17
FALHAS DE ENERGIA	17
PROGRAMAÇÃO DO CONTROLADOR	18
Ajuste de data e hora 	18
Configuração dos horários de início do programa 	19
Exclusão de um horário de início do programa	19
Configuração dos tempos de rega dos setores 	19
Configuração dos dias de rega 	19
Seleção da rega em dias específicos da semana	20
Seleção da rega em dias alternados	20
Seleção da rega em intervalos 	20
Seleção de dias específicos sem rega	20
Rega automática 	21
Desligar sistema 	21
Desligamento da rega programável	21
Ajuste sazonal %	21
Rega manual de um único setor 	22
Início e avanço manual com um toque	22
FUNÇÕES AVANÇADAS	23
Supressão programável do sensor	23
Programa de teste de todos os setores	23
Diagnóstico com o Hunter Quick Check™	23
Memória de programas Easy Retrieve™	24
Atraso programável entre setores	24
Redefinição do controlador/Apagamento da memória	24
INSTRUÇÕES SOBRE A ESPERA CLIK	25
Função de espera clik	25
FUNÇÕES OCULTAS	26
Programação personalizada	26
Ciclo e seca	27
Ajuste do tempo de ciclo	27
Acesso ao menu de seca	28
Ajuste do tempo de seca	28
Situações da função ciclo e seca	28
GUIA DE SOLUÇÃO DE PROBLEMAS	29
ESPECIFICAÇÕES	34
CERTIFICADO DE CONFORMIDADE COM AS DIRETRIZES	

COMPONENTES DO X-CORE

A Visor LCD		
1	 Tempos de rega	Permite programar o tempo de rega de cada válvula de setor, de 1 minuto a 4 horas
2	 Horários de início	Permite definir de 1 a 4 horários de início em cada programa
3	Número do setor	Indica o número do setor selecionado
4	Identificador de programa	Indica o programa que está em uso (A, B ou C)
5	Dia da semana	Indica o dia da semana
6	Intervalo de rega	Indica o mês quando a data atual é programada
7	Rega em dias alternados	Indica se a rega para dias pares ou ímpares foi selecionada
8	Aspersor piscando	Indica que a rega está em curso
9	 Desligar sistema	Permite interromper todos os programas e suspender a rega. Permite ainda definir a interrupção de rega programável, que suspende a rega por um período de 1 a 7 dias
10	 Guarda-chuva	Indica que o sensor de chuva está ativado
11	% Ajuste sazonal	Permite mudar os tempos de rega de acordo com as estações do ano, sem ter que reprogramar o controlador. As barras à esquerda servem de referência visual para o percentual do ajuste sazonal
12	 Gota de chuva	Indica que haverá rega no dia selecionado
13	 Gota de chuva cruzada	Indica que NÃO haverá rega no dia selecionado
14	 Calendário	Indica que o intervalo de rega foi programado. O ícone também aparece quando o dia atual é programado

COMPONENTES DO X-CORE

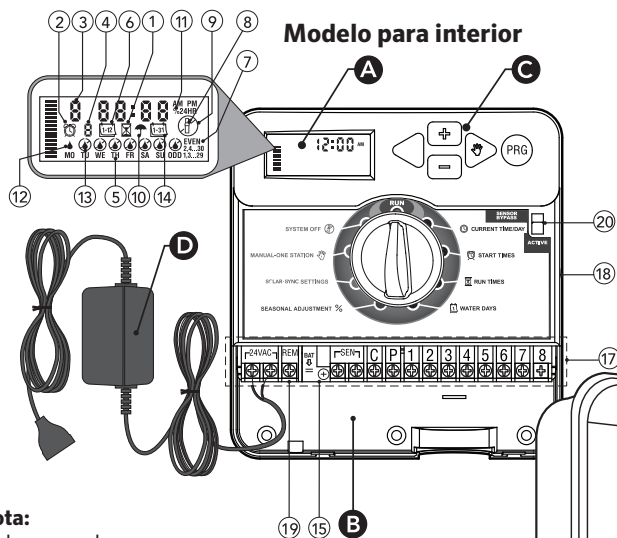

Nota:
o plugue pode
ser diferente da
ilustração



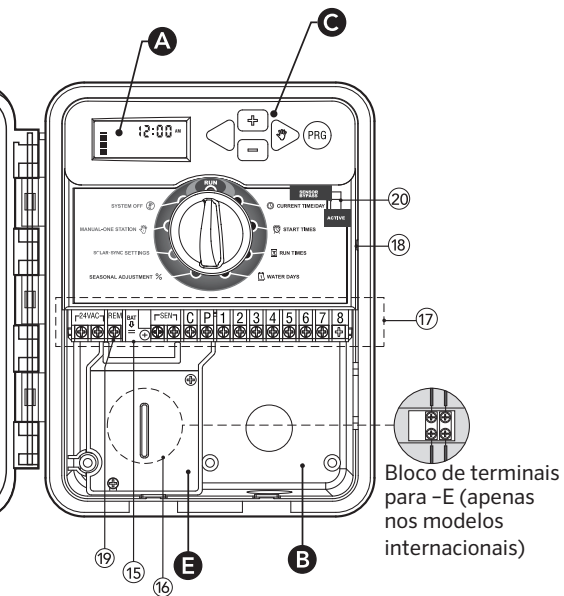



Modelo para exterior (transformador interno incluído)



COMPONENTES DO X-CORE

B Compartimento de fiação		
15	Bateria de lítio	A bateria de lítio substituível (incluída) permite que o controlador seja programado sem a alimentação CA, além de manter o relógio funcionando mesmo com a falta de energia
16	Caixa de ligação interna	Caixa de ligação presente nos modelos externos para fazer as ligações elétricas
17	Régua de terminais	Usada para ligar os fios do transformador, do sensor e da válvula ao controlador
18	Botão de redefinição	Usado para redefinir o controlador
19	REM	Permite a conexão do SmartPort e dos controles remotos da Hunter
20	Interruptor de supressão do sensor	Ignora os dados do sensor meteorológico "Clik" quando está na posição de supressão
C Botões de controle		
	Botão +	Aumenta o valor do item selecionado que está piscando no visor
	Botão -	Diminui o valor do item selecionado que está piscando no visor
	Botão ◀	Retorna ao item anterior
	Botão ▶	Avança a seleção para o próximo item
	Botão Ⓜ	Seleciona o programa A, B ou C de acordo com as necessidades específicas dos setores

COMPONENTES DO X-CORE

Opções do seletor		
	Regar	Posição normal do seletor para todas as operações manuais e automáticas do controlador
	 Data e hora atuais	Permite ajustar a data e a hora atuais
	 Horários de início	Permite definir de 1 a 4 horários de início em cada programa
	 Tempos de rega	Permite definir o tempo de rega de cada válvula de setor, de 1 minuto a 4 horas
	 Dias de rega	Permite selecionar os dias de intervalo para a rega
	% Ajuste sazonal	Permite mudar os tempos de rega de acordo com as estações do ano, sem ter que reprogramar o controlador. As barras à esquerda servem de referência visual para o percentual do ajuste sazonal
	 Manual - Um setor	Permite ativar uma só rega para um único setor
	 Desligar sistema	Permite interromper todos os programas e suspender a rega. Permite ainda definir a interrupção de rega programável, que suspende a rega por um período de 1 a 7 dias
	Configurações do SOLAR SYNC®	Permite alterar as configurações ao usar um sensor ET Solar Sync
D Transformador externo (apenas para o modelo de uso interno)		
		O transformador vem equipado com uma tomada para fornecer energia ao controlador

INSTALAÇÃO DO CONTROLADOR NA PAREDE



NOTA: a versão interna do X-Core não é à prova d'água nem resistente a intempéries, devendo ser instalada em ambiente interno ou área protegida.

1. Fixe um parafuso (A) na parede. Utilize buchas se for instalar o controlador em uma parede de consistência fraca.
2. Encaixe o parafuso no orifício (B) que se encontra no topo do controlador.
3. Parafuse o controlador na parede usando os orifícios (C) que ficam abaixo da régua de terminais.



NOTA: não ligue o transformador à energia elétrica até que o controlador esteja instalado na parede e as válvulas estejam conectadas.



NOTA: para o XC - x01 - A: se o cabo de alimentação estiver danificado, deverá ser substituído pelo fabricante, pelo representante de serviços ou por pessoa qualificada, a fim de evitar qualquer risco.



NOTA: para obter a máxima resistência contra água, a porta das unidades externas deve permanecer fechada.

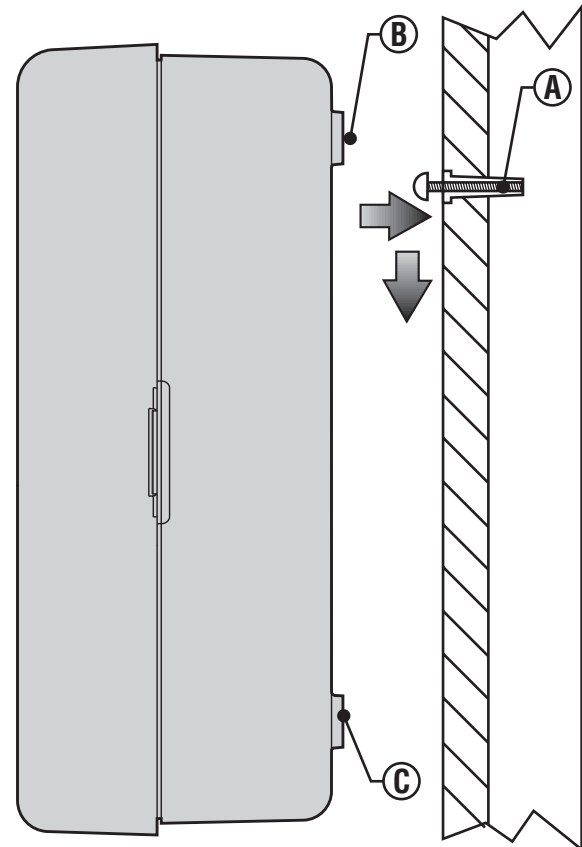

CONEXÃO DAS VÁLVULAS E DO TRANSFORMADOR

A instalação do X-Core só deve ser feita por pessoal treinado.

1. Passe os fios das válvulas desde o local da válvula de controle até o controlador.
2. Ligue um fio comum a um dos fios do solenoide de cada válvula, sendo geralmente um fio branco. Ligue o outro fio proveniente do controlador ao fio que sobrou em cada solenoide. Toda a instalação elétrica deve ser feita com conectores impermeáveis.
3. Passe os fios das válvulas pelo conduíte. Conecte o conduíte pela parte inferior direita do controlador.
4. Ligue o fio comum branco da válvula ao parafuso C (comum) da régua de terminais. Ligue cada um dos fios condutores individuais das válvulas ao respectivo terminal e aperte os parafusos.
5. Modelos internos: passe o cabo do transformador pelo orifício do lado esquerdo do controlador e conecte os fios aos dois parafusos com a marca 24VAC.



NOTA: o cabo do transformador interno não deve ser cortado. Se isso acontecer, os fios vermelho e branco do cabo devem ser unidos, ou o controlador não irá funcionar.

Modelos externos: os fios do transformador já ficam ligados aos terminais de CA, sendo necessário apenas conectar a alimentação primária à caixa de ligação.



NOTA: os modelos externos do X-Core são à prova d'água e resistentes a intempéries. Esses modelos só devem ser ligados à eletricidade por um electricista profissional, respeitando todas as normas de segurança locais. A instalação incorreta pode causar descargas elétricas ou risco de incêndio.

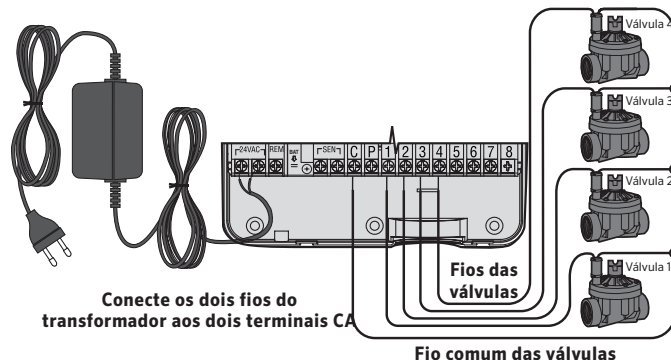

E Instalação elétrica de alta tensão (apenas para o modelo externo)

1. Passe o cabo elétrico e o conduíte pela abertura do conduíte de 13 mm (½") localizada na parte inferior esquerda do gabinete.
2. Conecte um fio a cada um dos dois fios dentro da caixa de ligação. O fio terra deve ser conectado ao fio verde. São fornecidos conectores de torção para fazer essas ligações.
Nota: apenas para os modelos -E: conecte os fios ao bloco de terminais CA dentro da caixa de ligação. Os fios de alimentação CA devem ser de 1,85 mm (14 AWG) ou maiores, com um disjuntor apropriado para o tamanho do fio. A instalação requer um interruptor ou disjuntor (próximo ao controlador e ao alcance do operador) que deve ser marcado como o dispositivo de desconexão do equipamento.
3. Troque a tampa da caixa de ligação.

ATIVAÇÃO DA BATERIA

Depois de instalar o X-Core, remova o isolante de contato da bateria para permitir que o relógio continue funcionando em caso de falta de energia.



ATENÇÃO:

há risco de explosão se a bateria for substituída por outra de tipo incorreto. Descarte as baterias usadas de acordo com as instruções.

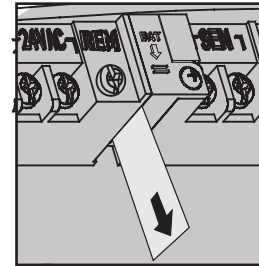

SUBSTITUIÇÃO DA BATERIA

O controlador X-Core vem equipado com uma bateria de lítio de longa duração. Com ela, é possível programar o controlador à distância, sem a necessidade da alimentação pela rede elétrica. A bateria também é útil para manter a data e a hora atuais em caso de falta de energia. Para trocar a bateria:

1. Retire o parafuso do suporte da bateria.
2. Mova o suporte da bateria para baixo para ter acesso a ela.
3. Troque a bateria antiga por uma nova e recoloque o suporte da bateria.

Bateria

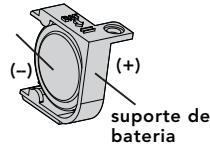

NOTA: o polo positivo (+) da bateria deve estar voltado para o interior do suporte.

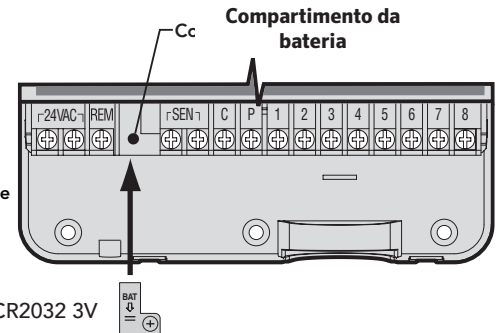

CONEXÃO DE UMA VÁLVULA MESTRE



NOTA: os procedimentos desta seção só devem ser realizados se houver uma válvula mestre instalada no seu sistema de irrigação. Válvula mestre é uma válvula "normalmente fechada" instalada no ponto de abastecimento da linha principal, e que só abre quando o controlador inicia um programa de rega.

1. Na válvula mestre, ligue o fio comum a um dos fios do solenóide da válvula. Ligue um fio de controle separado ao outro fio do solenóide.
2. O fio comum deve estar ligado ao terminal **C** dentro do controlador. O outro fio que sai da válvula mestre deve ser ligado ao terminal **P** dentro do controlador. Aperte cada parafuso do terminal.

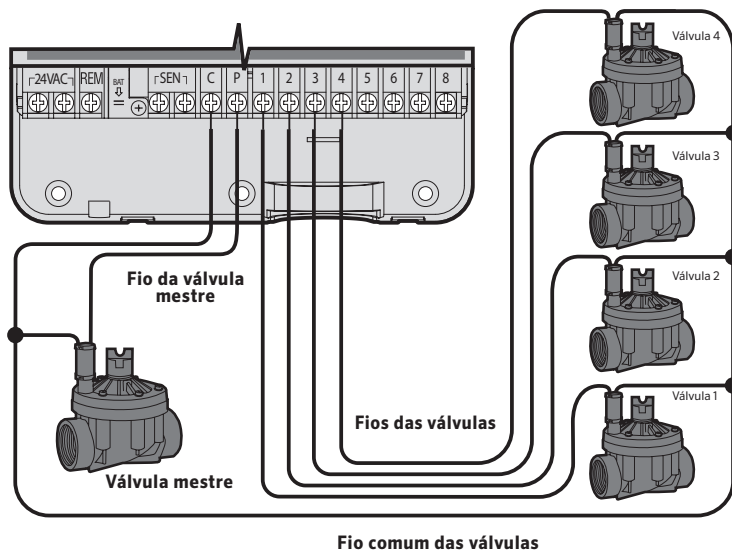

CONEXÃO DE UM RELÉ DE PARTIDA DA BOMBA



NOTA: os procedimentos desta seção só devem ser realizados se houver um relé de partida da bomba instalado. Um relé de partida de bomba é um dispositivo que utiliza um sinal do controlador para acionar um circuito elétrico separado, responsável por estimular uma bomba que fornece água ao sistema.

O controlador deve ser instalado a pelo menos 4,5 m (15 ft) de distância do relé de partida da bomba e da própria bomba, a fim de minimizar possíveis interferências elétricas.

1. Passe dois fios do relé da bomba até o controlador.
2. Ligue um fio comum ao terminal **C** (comum - normalmente um fio branco) dentro do controlador, e ligue o outro fio do relé de partida da bomba ao terminal **P**.

A corrente de retenção do relé não deve exceder 0,3 A. Não conecte o controlador diretamente à bomba, pois isso irá danificá-lo.

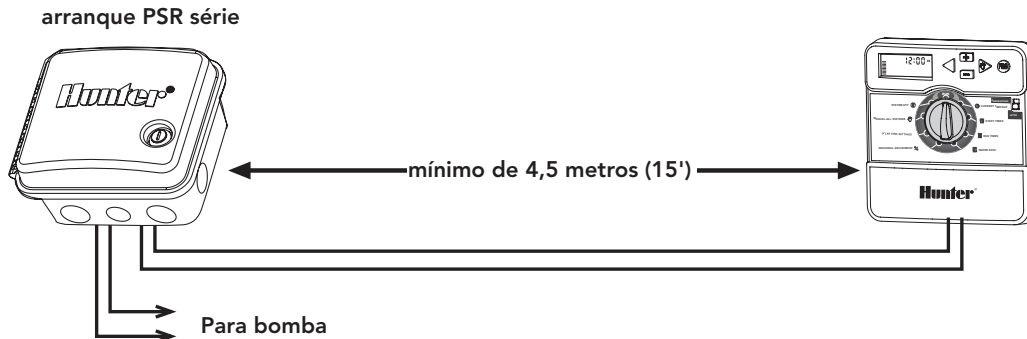



CONEXÃO DE UM SENSOR METEOROLÓGICO "CLIK" DA HUNTER

Um sensor meteorológico da Hunter ou outro sensor do tipo micro-switch pode ser conectado ao X-Core. O objetivo desse sensor é suspender a rega automaticamente, quando necessário, em função das condições meteorológicas.

1. **Remova a placa conectora metálica** que une os dois terminais SEN dentro do controlador.
2. Ligue cada fio a cada um dos terminais SEN.

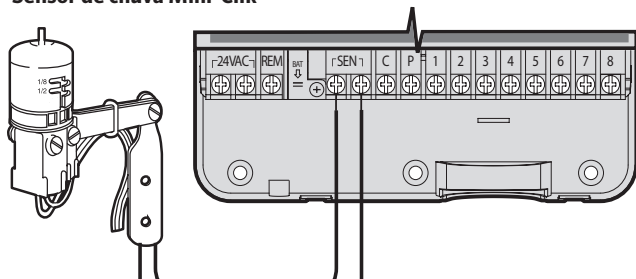
Sensor de chuva Mini-Clik®



Quando o sensor meteorológico suspende a rega automática, a palavra **DESLIGADO** e o símbolo  aparecem no visor.



Teste do sensor meteorológico

O X-Core permite testar um sensor de chuva facilmente quando ele está conectado ao circuito do sensor. Para verificar se o sensor de chuva está funcionando corretamente, basta executar um **CICLO AUTOMÁTICO** ou ativar o sistema usando a função **CICLO AUTOMÁTICO com um toque** (veja a página 22). Durante o ciclo manual, se o botão superior do sensor for pressionado, a rega será interrompida.

Suspendendo o sensor de chuva

Se o sensor de chuva estiver suspendendo a rega, é possível ignorá-lo usando o botão de supressão na parte frontal do controlador. Mova o botão para o **SUSPENDER SENSOR** para desativar o sensor de chuva e permitir que o controlador opere. Quando a função **MANUAL - UM SETOR** for utilizada, o controlador irá ignorar o sensor automaticamente pelo período de tempo selecionado. Após o fim desse período, o controlador voltará para as configurações selecionadas.



NOTA: a ativação do botão de supressão do sensor não afeta as atualizações de ajuste sazonal do sensor Solar Sync. Porém, as funções Rain Clik e Freeze Clik do sensor serão ignoradas.

CONEXÃO DE UM SENSOR ET SOLAR SYNC DA HUNTER

O X-Core é compatível com os sistemas Solar Sync e Solar Sync sem fio. O Solar Sync é um sistema de sensor que ajusta automaticamente a programação da rega do controlador X-Core (com base nas alterações das condições climáticas locais) usando a função de ajuste sazonal. O Solar Sync utiliza um sensor solar e térmico para medir a evapotranspiração (ET), ou seja, a velocidade de consumo de água por plantas e gramados. Além disso, ele conta com as tecnologias Rain Klik e Freeze Klik da Hunter, que desligam a rega em caso de chuva ou condições de congelamento.



NOTA: nas primeiras 24 horas, o Solar Sync utiliza um valor de ajuste sazonal de 100%, até que o sensor envie os dados meteorológicos do primeiro dia completo.



NOTA: a ativação do botão de supressão do sensor não afeta os ajustes sazonais provenientes do sensor Solar Sync. Porém, as funções Rain Klik e Freeze Klik do sensor serão ignoradas.



NOTA: o módulo do Solar Sync não é necessário para a instalação usando o controlador X-core.

Instalação do sensor Solar Sync

Conecte os fios verde e preto do sensor Solar Sync aos terminais de ligação "SEN" do controlador X-Core. Não importa qual fio será conectado a qual terminal. Gire o seletor para a posição Configurações do Solar Sync. Inicialmente, o visor mostrará linhas pontilhadas

e depois exibirá o ajuste da região predefinida (3), do lado esquerdo, e a configuração do ajuste de rega (5), do lado direito.



Instalação do Solar Sync sem fio

Ligue os fios verde e preto do receptor do Solar Sync sem fio aos terminais de ligação "SEN" do controlador X-Core. Não importa qual fio será conectado a qual terminal. Gire o seletor para a posição Configurações do Solar Sync. Inicialmente, o visor mostrará linhas pontilhadas e depois exibirá o ajuste da região predefinida (3), do lado esquerdo, e a configuração do ajuste de rega (5), do lado direito.



Configurações do Solar Sync

Se um sensor Solar Sync estiver conectado ao controlador X-Core, serão mostrados dois números no visor quando o seletor estiver na posição de configurações do Solar Sync. O número à esquerda na tela corresponde ao ajuste de Região, e o número à direita representa as configurações de Ajuste de rega (como mostrado acima).

Para que o Solar Sync produza medições precisas, o controlador deve ser programado com os valores médios de ET (da estação de pico) da sua região. Use a tabela da página seguinte para determinar a sua região. Use os botões  ou  para selecionar a sua região (1 a 4).

CONEXÃO DE UM SENSOR ET SOLAR SYNC DA HUNTER

Região

Para que o Solar Sync produza medições precisas, o controlador deve ser programado com a ET média da estação de pico da sua região. Use a tabela a seguir para determinar a sua região.

Esta tabela ajudará você a identificar o tipo de região em que mora. Há quatro regiões básicas de ET, cada qual com suas respectivas descrições, juntamente com as características típicas de ET e temperatura. É recomendável que, se possível, a região seja escolhida com base na ET média de julho ou na ET de pico do verão (milímetros/polegadas por dia).

Utilize a tabela a seguir para escolher a sua região (veja abaixo). As opções **A**, **B** ou **C** podem ser usadas para ajudar você a escolher qual é a região mais adequada para o seu caso:

- A)** Com base na ET da sua região, usando a ET **média** de julho ou a ET de pico do verão (milímetros/polegadas por dia). Essa é a opção preferencial ao selecionar a sua região.
- B)** Com base na temperatura da sua região, usando a **média** de julho ou a temperatura alta do mês mais seco (não a temperatura mais alta de julho).
- C)** Com base na descrição geral da sua região.

DEFINA A SUA REGIÃO EM FUNÇÃO DAS SEGUINTE CONDIÇÕES METEOROLÓGICAS.			
	A	B	C
Região 1	Se a ET média de julho for: < 4,3 mm (0,17") por dia	Se a temperatura média de julho for: entre 18 °C - 24 °C (65 °F - 75 °F)	<ul style="list-style-type: none"> • Regiões de alta latitude • Regiões costeiras
Região 2	Se a ET média de julho for: de 4,6 mm - 5,8 mm (0,18" - 0,23") por dia	Se a temperatura média de julho for: entre 24 °C - 29 °C (75 °F - 85 °F)	<ul style="list-style-type: none"> • Regiões montanhosas • Regiões continentais de alta latitude
Região 3	Se a ET média de julho for: de 6,1 mm - 7,4 mm (0,24" - 0,29") por dia	Se a temperatura média de julho for: entre 29 °C - 35 °C (85 °F - 95 °F)	<ul style="list-style-type: none"> • Regiões de baixa latitude • Regiões continentais/desérticas
Região 4	Se a ET média de julho for: > 7,6 mm (0,30") por dia	Se a temperatura média de julho for: entre 35 °C - 41 °C (95 °F - 105 °F)	<ul style="list-style-type: none"> • Desertos

* Para regiões do hemisfério sul, considere o mês de janeiro.

CONEXÃO DE UM SENSOR ET SOLAR SYNC DA HUNTER

Ajuste da rega ↑±



O ajuste da rega é uma escala de 1 a 10 que permite alterar facilmente o valor do ajuste sazonal do sensor ET Solar Sync. Após a instalação desse sensor, é recomendável deixar o ajuste da rega no valor predefinido de 5. Porém, após a instalação, se você achar que o valor do ajuste sazonal está muito baixo ou alto, ele poderá ser modificado para alterar o valor resultante do ajuste sazonal. Consulte a seção Calibração/Configuração na página 15 para saber como usar a escala do ajuste de rega para alterar o valor do ajuste sazonal.



NOTA: se um setor específico estiver mais úmido ou seco que os outros, basta aumentar ou diminuir o valor do tempo de rega no controlador.

Desinstalação de um sensor Solar Sync

Se um sensor Solar Sync tiver sido instalado no controlador X-Core, o valor do ajuste sazonal usado pelo controlador será calculado com base nos dados meteorológicos fornecidos pelo sensor. Para deixar de usar o sensor Solar Sync com o controlador X-Core, é necessário desinstalar o sensor. **Se ele não for desinstalado, o controlador não permitirá que o valor de ajuste sazonal seja alterado manualmente.** Por exemplo, se o valor do ajuste sazonal mostrado no controlador for de 50% quando o sensor Solar Sync for removido, esse valor permanecerá em 50% até que o sensor seja desinstalado.

Para desinstalar o sensor Solar Sync, basta desconectar os fios verde e preto do terminal do controlador e depois girar o seletor para a posição Configurações do Solar Sync. O visor mostrará alguns traços, indicando que o controlador deixou de reconhecer o sensor para o cálculo do ajuste sazonal. Com isso, o valor do ajuste sazonal poderá ser alterado manualmente, girando o seletor para a posição Ajuste Sazonal e usando os botões  ou  para ajustar o valor.

CONEXAO DE UM SENSOR ET SOLAR SYNC DA HUNTER

Calibração/Configuração

Depois de instalar e programar o Solar Sync, é recomendável deixar o sistema funcionando durante alguns dias com os parâmetros iniciais. Devido a uma série de condições locais (incluindo a localização do sensor, a quantidade de luz solar direta disponível para o sensor, o calor refletido pelas estruturas do entorno, etc.), **os parâmetros iniciais poderão ter que ser ajustados para obter o desempenho desejado.** A calibração do Solar Sync para um determinado local pode ser feita com facilidade por meio da configuração dos ajustes de rega e/ou da região. As instruções a seguir descrevem esse processo:

1. Instale o sensor Solar Sync.
2. Programe a região e deixe o sistema funcionar com os parâmetros iniciais durante pelo menos 3 dias (consulte a página 13 para ver as instruções sobre a configuração da região).
3. Fique atento ao ajuste sazonal no controlador. Se o valor do ajuste sazonal parecer mais baixo ou mais alto do que o esperado para um dado período do ano, os parâmetros do Solar Sync terão que ser ajustados.
 - a. **Ajuste sazonal muito baixo:** gire o seletor para a posição Configurações do Solar Sync e aumente o valor do ajuste da rega (o máximo é 10). Após alterar o parâmetro, o controlador será atualizado automaticamente com o novo percentual de ajuste sazonal. Aumente o parâmetro do ajuste da rega até chegar ao percentual desejado para o ajuste sazonal. **Se o valor máximo do ajuste da rega for atingido (ou seja, 10), mas mesmo assim for necessário aumentar o ajuste sazonal, passe para a região anterior (por exemplo, da região 4 para a 3).**
 - b. **Ajuste sazonal muito alto:** Gire o seletor para a posição Configurações do Solar Sync e diminua o valor do ajuste de rega (o valor predefinido é 5). Após alterar o parâmetro, o controlador será atualizado automaticamente com o novo percentual de ajuste sazonal. Diminua o parâmetro do ajuste de rega até chegar ao percentual desejado para o ajuste sazonal. **Se o valor mínimo do ajuste de rega for atingido (ou seja, 1), mas mesmo assim for necessário reduzir o ajuste sazonal, passe para a região seguinte (por exemplo, da região 2 para a 3).**

Tempos de rega dos setores: é importante entender que o Solar Sync oferece um ajuste sazonal geral para o controlador. Isso significa que todos os tempos de rega dos setores serão modificados segundo o percentual de ajuste sazonal exibido. Ao programar o controlador, os tempos de rega devem ser inseridos de modo a representar as programações de rega de pico da estação. Se o Solar Sync for ajustado para o valor de ajuste sazonal apropriado, mas o tempo de rega de um determinado setor parecer muito longo ou curto, ajuste o tempo de rega do setor no programa do controlador.

FUNÇÃO DE ESPERA DO SOLAR SYNC

Espera do Solar Sync para o X-CORE®

A função de espera só pode ser acessada depois da instalação do Solar Sync. Essa função permite que o usuário adie alterações de ajuste sazonal que seriam feitas pelo Solar Sync por até 99 dias.

Enquanto a espera do Solar Sync estiver ativa, o Solar Sync continuará a coletar e armazenar dados.

Operação:

Para acessar o ajuste de espera do Solar Sync:

1. Coloque o seletor na posição REGAR. Segure o botão **+**, gire o seletor para a posição Solar Sync e solte o botão **+**. A tela a seguir será mostrada: **d:XX** (onde **d** indica os dias e **XX** indica o número de dias de espera).
2. Pressione os botões **+** ou **-** para aumentar ou diminuir o número de dias de espera. Quando o número desejado de dias de espera for exibido, coloque o seletor na posição **REGAR** para ativar a espera.

Para alterar o ajuste existente de dias de espera:

1. Abra o menu de espera do Solar Sync pressionando o botão **+**, gire o seletor para as configurações do Solar Sync e solte o botão **+**.
2. Use as teclas + ou - para modificar o número de dias até que o número desejado de dias de espera seja exibido. (Se o número de dias for ajustado para 00, a espera do Solar Sync será **DES-LIGADA**.)
3. Volte o seletor para a posição **REGAR** para que as alterações entrem em vigor.

Enquanto a espera do Solar Sync estiver ativa, o Solar Sync continuará a coletar informações meteorológicas e a calcular o valor do ajuste sazonal. O ajuste sazonal atualizado será aplicado quando os dias de espera do Solar Sync atingirem 00.



NOTA: o número de dias restantes não será exibido na tela **REGAR**. Para verificar se a função de espera está ativa, abra o menu de espera do Solar Sync e veja os dias exibidos. Se houver 1 ou mais dias exibidos, isso quer dizer que a espera do Solar Sync está ativa; se 00 for exibido, é porque a espera do Solar Sync não está ativa.

CONEXÃO A UM CONTROLE REMOTO HUNTER

Conexão a um controle remoto Hunter (não incluído)

O controlador X-Core é compatível com os controles remotos da Hunter (não incluídos). O chicote elétrico SmartPort® (incluído com todos os controles remotos Hunter) permite que os controles remotos Hunter sejam usados de forma fácil e rápida. Com os controles remotos, os instaladores e usuários podem operar o sistema sem ter que se deslocar até o controlador.

Instalação do conector SmartPort

1. Instale uma derivação em T com rosca fêmea de 1/2" no conduíte da fiação de campo (não incluído), aproximadamente 30 cm abaixo do X-Core.
2. Passe os fios vermelho, branco e azul do chicote pela base do "T" e para dentro do compartimento da fiação, como mostrado.

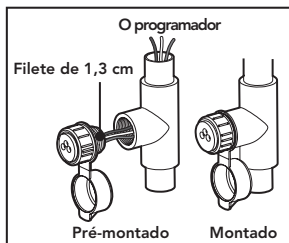

NOTA: o P/N 258200 pode ser usado como método alternativo para montar o conector SmartPort.

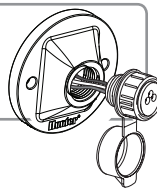

3. Aperte o chicote do SmartPort.
4. Ligue os fios vermelho, branco e azul do SmartPort ao terminal do controlador, conforme mostrado abaixo:
 - Fio vermelho no terminal "24VAC" do lado esquerdo
 - Fio branco no terminal "24VAC" do lado direito
 - Fio azul no terminal "REM"

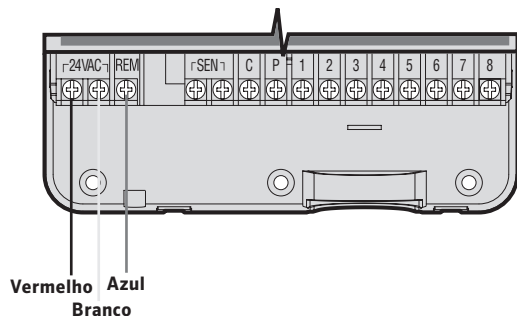

FALHAS DE ENERGIA



Devido à possibilidade de falta de energia, o controlador possui uma memória não volátil. As informações programadas não serão perdidas mesmo em caso de falta de energia. A bateria de lítio mantém o relógio funcionando mesmo sem a energia da rede elétrica. Além disso, a rega volta a funcionar normalmente quando a eletricidade é restabelecida.

PROGRAMAÇÃO DO CONTROLADOR

O visor do X-Core mostra a data e a hora quando o controlador está inativo. Quando o seletor é girado, o visor muda para indicar as informações de uma programação específica. Durante a programação, a parte que estiver piscando no visor pode ser alterada usando os botões **+** ou **-**. Para alterar um item que não esteja piscando, pressione os botões **◀** ou **▶** até que o item desejado comece a piscar.

Cada um dos três programas disponíveis (A, B e C) pode ter quatro horários de início diários, permitindo que plantas com necessidades específicas sejam regadas em diferentes horários durante o dia.

Ajuste de data e hora ⌚

1. Gire o seletor para a posição **DATA E HORA ATUAIS**
2. O ano atual ficará piscando. Use os botões **+** ou **-** para alterar o ano. Depois de ajustar o ano, pressione o botão **▶** para passar para ajuste do mês.
3. O dia e o mês aparecerão no visor. O mês ficará piscando, e o símbolo  aparecerá. Use os botões **+** ou **-** para alterar o mês. Pressione o botão **▶** para passar para o ajuste do dia.
4. O dia ficará piscando, e o símbolo  aparecerá. Use os botões **+** ou **-** para alterar o dia. Pressione o botão **▶** para passar para o ajuste da hora.
5. A hora aparecerá no visor. Use os botões **+** ou **-** para selecionar AM, PM ou 24 horas. Pressione o botão **▶** para selecionar a hora. A hora ficará piscando. Use os botões **+** ou **-** para alterar a hora mostrada no visor. Pressione o botão **▶** para selecionar os minutos. Os minutos ficarão piscando. Use os botões **+** ou **-** para alterar os minutos mostrados no visor. Com isso, a data e a hora estarão ajustadas.



NOTA: uma regra básica da programação é que o símbolo ou item piscando no visor é sempre aquele que será programado. Por exemplo, ao ajustar o horário, se a hora estiver piscando, ela poderá ser alterada ou programada. Para fins ilustrativos deste manual, os itens em CINZA são os que estarão piscando no visor.

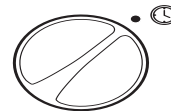

Data e hora atuais

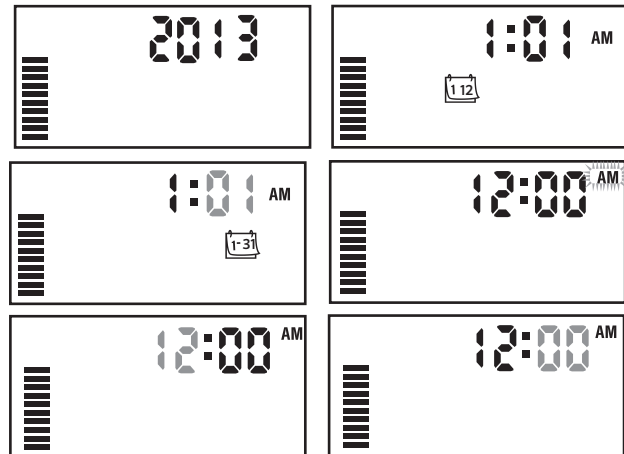

PROGRAMAÇÃO DO CONTROLADOR

Configuração dos horários de início do programa

1. Gire o seletor para a posição **HORÁRIOS DE INÍCIO**
2. O programa A é o predefinido de fábrica. Se necessário, selecione os programas B ou C usando o botão **PROG**.
3. Use os botões **+** ou **-** para alterar o horário de início (os horários de início são alterados com acréscimos de 15 minutos).
4. Pressione o botão **▶** para adicionar mais um horário de início, ou o botão **PROG** para mudar para o próximo programa.

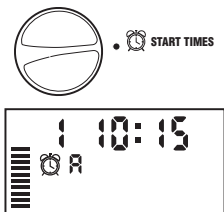

NOTA: um horário de início ativa todos os setores de um determinado programa em sequência. Isso evita ter que inserir o horário de início de cada setor. Em um programa, é possível usar vários horários de início para ciclos de rega separados nos períodos da manhã, tarde e noite. Os horários de início podem ser inseridos em qualquer ordem. O X-Core irá ordená-los automaticamente.



Exclusão de um horário de início do programa

Com o seletor na posição **HORÁRIOS DE INÍCIO**, pressione os botões **+** ou **-** até que 12:00 AM (meia-noite) apareça no visor. Pressione o botão **-** uma vez para mudar para a posição Desligado. Pressione a seta para a direita para excluir um segundo horário de início.

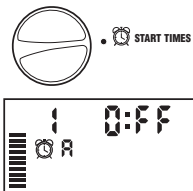



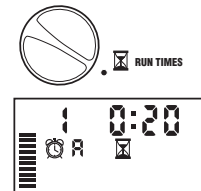

Configuração dos tempos de rega dos setores

1. Gire o seletor para a posição **TEMPOS DE REGA**
2. O visor exibirá o último programa selecionado (A, B ou C), o número do setor selecionado e o símbolo , e o setor ficará piscando. Para mudar para outro programa, basta pressionar o botão **PROG**.
3. Use os botões **+** ou **-** para mudar o tempo de rega do setor mostrado no visor. É possível programar o tempo de rega de 0 a 4 horas.
4. Pressione o botão **▶** para avançar para o próximo setor.







Configuração dos dias de rega

1. Gire o seletor para a posição **DIAS DE REGA**
2. O visor mostrará o último programa selecionado (A, B, ou C). Para mudar para outro programa, basta pressionar o botão **PROG**.
3. O controlador mostrará os sete dias da semana (SE, TE, QA, QI, SX, SA e DO). Cada dia terá os símbolos  ou  sobre ele. O símbolo  representa um dia com rega, e o símbolo  corresponde a um dia sem rega.



PROGRAMAÇÃO DO CONTROLADOR





Seleção da rega em dias específicos da semana

- Com o cursor  posicionado sobre um dia específico (ele começa sempre na segunda-feira), pressione o botão  para ativar a rega em um dia específico da semana. Pressione o botão  para cancelar a rega naquele dia. Depois de pressionar um botão, o cursor avança automaticamente para o dia seguinte.
- Repita o passo anterior até selecionar os dias de rega desejados. Os dias selecionados ficarão marcados com o símbolo  para indicar que a rega será ativada. O último dia marcado com o símbolo  será o último dia de rega daquele programa.



Seleção da rega em dias alternados

Essa função usa a numeração dos dias do mês em vez de dias específicos da semana (dias ímpares: 1, 3, 5, etc.; dias pares: 2, 4, 6, etc.).



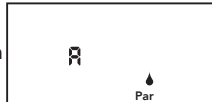
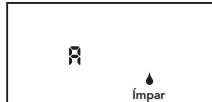

- Pressione a seta para a direita  até que o cursor esteja sobre o domingo (DO).
- Pressione a seta para a direita mais uma vez. A opção Ímpar aparecerá, junto com o [ícone de gota de chuva]. Se desejar que a rega seja feita em dias ímpares, recoloque o seletor na posição Regar.
- Se desejar a rega em dias pares, pressione o botão  uma vez. O símbolo  e a palavra **PAR** aparecerão no visor. É possível selecionar **ÍMPAR** ou **PAR**, alternadamente, pressionando os botões  ou .



NOTA: o dia 31 de cada mês e o dia 29 de fevereiro são sempre dias "inativos" se a opção de rega em dias ímpares for selecionada.

Seleção da rega em intervalos

Com essa opção é possível selecionar intervalos de rega de 1 a 31 dias.

- Com o cursor posicionado sobre **PAR** ou **ÍMPAR**, pressione o botão  uma vez. Com isso, o símbolo  aparecerá no visor, e o número 1 ficará piscando. A programação de rega em intervalos aparecerá no visor.
- Pressione os botões  ou  para selecionar o número de dias entre os dias de rega (de 1 a 31 dias). Esse período é chamado de intervalo.



O controlador fará a rega do programa selecionado no próximo horário de início e depois regará no intervalo programado.



Nota: para sair do modo de intervalo (conforme necessário), pressione o botão da seta para a esquerda até que a exibição dos dias da semana volte a aparecer.

Seleção de dias específicos sem rega

O X-Core permite programar dias específicos sem rega. Essa função é útil para suspender a rega em dias específicos. Por exemplo, se você sempre corta a grama aos sábados, é possível definir o sábado como um **dia sem rega** para que a grama não esteja molhada ao podá-la.

PROGRAMAÇÃO DO CONTROLADOR

1. Gire o seletor para a posição **DIAS DE REGA**.
2. Insira uma programação de rega em intervalos, conforme descrito na página 19.
3. Pressione o botão ► para ir para a função **dias sem rega** na parte inferior do visor. O dia correspondente à segunda-feira (SE) ficará piscando.
4. Use o botão ► para posicionar o cursor no dia da semana que deverá ser um dia sem rega.
5. Pressione o botão ■ para selecionar esse dia como um dia sem rega. O símbolo ☹ aparecerá acima desse dia.
6. Repita os passos 4 e 5 até que todos os dias desejados estejam programados como dias sem rega.



NOTA: na programação da rega em intervalos, também há a opção de programar dias pares ou ímpares sem rega.

Rega automática

Após programar o X-Core, gire o seletor para a posição **REGAR** para permitir a execução automática de todos programas de rega selecionados.

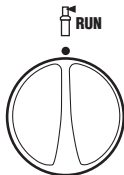

Desligar sistema

As válvulas que estiverem irrigando serão desligadas quando o seletor for colocado na posição **DESLIGAR SISTEMA** por dois segundos. Todos os programas ativos serão interrompidos, e a rega será suspensa. Para que o controlador volte à operação automática normal, basta girar o seletor para a posição **REGAR**.

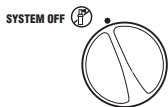

Desligamento da rega programável

Essa função permite que o usuário suspenda todas a regas programadas por um período de 1 a 7 dias. Ao fim desse período, o controlador volta à operação automática normal.

1. Gire o seletor para a posição **DESLIGAR SISTEMA**. Espere até que **DESLIGADO** apareça no visor.
2. Pressione o botão ■ tantas vezes quanto for necessário para definir o número de dias sem rega (até 7 dias).
3. Recoloque o seletor na posição **REGAR**. Com isso, o visor exibirá **DESLIGADO**, um número e os símbolos ☹ e ☹.

O número de dias restantes sem rega diminuirá à meia-noite de cada dia. Ao chegar a zero, o visor mostrará a hora normal do dia, e a rega normal será retomada no próximo horário de início programado.



Ajuste sazonal %

O ajuste sazonal é usado para fazer alterações gerais nos tempos de rega sem a necessidade de reprogramar todo o controlador. Para usar a função de ajuste sazonal:

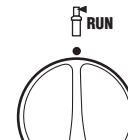
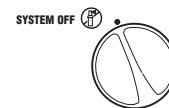
1. Gire o seletor para a posição **AJUSTE SAZONAL**.
2. O visor mostrará um número piscando seguido pelo símbolo %, bem como o gráfico de barras que sempre permanece no



PROGRAMAÇÃO DO CONTROLADOR

visor. Pressione os botões  ou  para ajustar o percentual do ajuste sazonal desejado. Cada barra do gráfico equivale a 10%. Essa função permite que o controlador faça um ajuste de 10% a 150% no programa original.

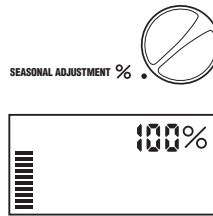



Para ver os tempos de rega ajustados, gire o seletor para a posição **TEMPOS DE REGA**, e o tempo de rega exibido será atualizado à medida que o ajuste sazonal for realizado.







NOTA: inicialmente, o controlador deve ser programado sempre na posição de 100%.

Ao usar um sensor meteorológico "Clik" da Hunter, o valor do ajuste sazonal pode ser ajustado conforme descrito anteriormente.

Ao usar um sensor ET Solar Sync, o valor do ajuste sazonal é atualizado diariamente de forma automática, com base nos dados do sensor. O sensor ET Solar Sync registra padrões meteorológicos, determina o valor ideal do ajuste sazonal e atualiza o controlador diariamente. Para ignorar esse valor e fazer o ajuste manual, basta pressionar os botões  ou  até atingir o valor de ajuste sazonal desejado. **Contudo, é importante entender que o valor de ajuste sazonal definido manualmente será substituído, à meia-noite, pelo valor atualizado do sensor Solar Sync.**









Para reverter para um modo manual, o sensor Solar Sync deve ser desinstalado. Veja instruções sobre como desinstalar o sensor Solar Sync na página 14.

Rega manual de um único setor

1. Gire o seletor para a posição **MANUAL - UM SETOR**.  
2. O tempo de rega do setor ficará piscando no visor. Use o botão  para escolher o setor desejado. É possível usar os botões  ou  para determinar o tempo de rega de um setor.
3. Gire o seletor no sentido horário até a posição **REGAR** para irrigar o setor (somente o setor escolhido será regado, e o controlador voltará ao modo automático sem nenhuma mudança na programação anterior). Veja também a função **Início e avanço manual com um toque**.

Início e avanço manual com um toque

Também é possível ativar a rega de todos os setores sem usar o seletor.

1. Segure o botão  por 2 segundos.
2. Essa função é automaticamente predefinida para o programa A, mas é possível selecionar os programas B ou C com o botão .
3. O número do setor ficará piscando. Pressione o botão  para selecionar os setores, e os botões  ou  para ajustar os tempos de rega do setor (se nenhum botão for pressionado por alguns segundos durante os passos 2 e 3, o controlador iniciará a rega automaticamente).
4. Pressione o botão  para selecionar o setor que deverá iniciar a rega. Após um pausa de 2 segundos, o programa começará a funcionar. A qualquer momento durante o ciclo manual, é possível usar os botões  ou  para mudar de um setor para o outro manualmente.

FUNÇÕES AVANÇADAS

Supressão programável do sensor

O X-Core permite que o usuário programe o controlador para que o sensor interrompa a rega apenas nos setores desejados. Por exemplo, jardins em áreas cobertas, onde haja vasos sob beirais ou tetos, podem não receber água da chuva e continuarão precisando de rega durante períodos chuvosos. Para programar a supressão do sensor:

1. Gire o seletor para a posição **REGAR**.
2. Segure o botão e, ao mesmo tempo, gire o seletor para a posição **HORÁRIOS DE INÍCIO**.
3. Solte o botão . Com isso, o visor exibirá o número do setor, **LIGADO** e o símbolo piscando.

4. Pressione os botões ou para ativar ou desativar o sensor naquele setor.

LIGADO = Sensor ligado (irá suspender a rega)

DESLIGADO = Sensor desligado (irá permitir a rega)

5. Use os botões ou para ir para o próximo setor em que deva haver a supressão do sensor.

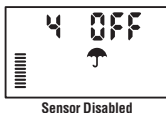
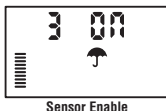
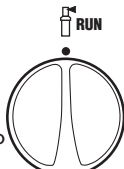

NOTA: o controlador vem pré-programado para que o sensor interrompa a rega em todos os setores em caso de chuva.

Quando o X-Core recebe um sinal do sensor para interromper a rega, o visor mostra os setores programados para ignorar o sensor. Se um setor estiver sendo irrigado no modo de supressão do sensor, os símbolos e ficarão piscando alternadamente.

Programa de teste de todos os setores

O X-Core disponibiliza um método simplificado para que o usuário execute um programa de teste. Essa função executa cada setor em uma sequência numérica, do menor para maior número.

1. Com o seletor na posição **REGAR**, segure o botão . O número do setor aparecerá no visor, e a hora ficará piscando por dois segundos.
2. Use os botões ou para ajustar o tempo de rega de 1 a 15 minutos. Só é necessário ajustar o tempo de rega uma vez.
3. Após uma pausa de 2 segundos, o programa de teste será iniciado.

Diagnóstico com o Hunter Quick Check™

Essa função permite realizar um diagnóstico rápido de problemas na fiação do controlador. Em vez de verificar cada circuito elétrico no campo para ver se há possíveis problemas, você pode usar o teste de circuitos Hunter Quick Check. Para iniciar o teste Quick Check:

1. Pressione os botões , , e simultaneamente. No modo de espera, o visor mostrará todos os segmentos.
2. Pressione o botão uma vez para iniciar o teste Quick Check. Em alguns segundos, o sistema analisará todos os setores para detectar problemas no circuito. Quando um curto-circuito for detectado, o símbolo ERR, precedido pelo número do setor, piscará momentaneamente no visor. Depois que o Quick Check concluir o diagnóstico de todo o circuito, o controlador voltará ao modo de rega automática.

FUNÇÕES AVANÇADAS

Memória de programa Easy Retrieve™

O X-Core é capaz de salvar um programa de rega preferido na memória e recuperá-lo quando necessário. Essa é uma maneira rápida de reajustar o controlador para a programação de rega original.

Para salvar o programa na memória

1. Com o seletor na posição **REGAR**, segure os botões **+** e **PRG** por 5 segundos. Serão mostrados três segmentos passando da esquerda para a direita, indicando que o programa está sendo salvo na memória.
2. Solte os botões **+** e **PRG**.

Para recuperar um programa salvo na memória.

1. Com o seletor na posição **REGAR**, segure os botões **-** e **PRG** por 5 segundos. Serão mostrados três segmentos passando da direita para a esquerda, indicando que o programa está sendo recuperado da memória.
2. Solte os botões **-** e **PRG**.

Atraso programável entre setores

Essa função permite que o usuário programe um tempo de espera entre o desligamento de um setor e o acionamento de outro.

1. Com o seletor na posição **REGAR**.
2. Segure o botão **-** e, ao mesmo tempo, gire o seletor para a posição **TEMPOS DE REGA**.
3. Solte o botão **-**. Com isso, o visor mostrará o tempo de espera de todos os setores em segundos, que ficará piscando.
4. Pressione os botões **+** ou **-** para aumentar ou diminuir o tempo de espera, entre 0 e 4 horas.
5. Recoloque o seletor na posição **REGAR**.

Redefinição do controlador/Apagamento da memória

Se o controlador tiver sido mal programado, há uma função que permite que a memória volte aos padrões de fábrica, apagando todos os programas e dados inseridos no controlador.

1. Segure o botão **PRG**.
2. Enquanto segura o botão **PRG**, pressione e solte o botão que fica na lateral direita do controlador.
3. Continue segurando o botão **PRG** até aparecer a hora 12:00 am (leva cerca de 8 segundos).

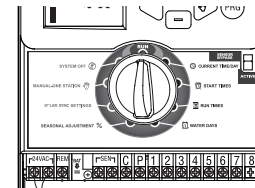

Redefinição

INSTRUÇÕES SOBRE A ESPERA CLIK

Função de espera clik

Essa função permite que o usuário adie as regas programadas por um período escolhido (de 1 a 7 dias) APÓS o fim de um evento Clik. Ao fim de um período de espera clik programado, o controlador retomará a operação automática normal.

1. Gire o seletor para a posição **REGAR**.
2. Segure o botão **+** por 3 segundos e depois gire o seletor para a posição **DESLIGADO**.
3. Solte o botão **+**. O visor mostrará a espera clik programável.



4. Pressione o botão **+** para definir a duração da espera clik (de 1 a 7 dias).
5. Recoloque o seletor na posição REGAR. Com isso, a espera clik estará definida.

Após o fim de um evento Clik (quando o sensor de chuva muda de úmido para seco), a função de espera clik ficará ativa e a duração da espera clik será mostrada na tela. A contagem regressiva dos dias ocorrerá 24 horas após o início da espera clik.



Para cancelar uma espera clik ativa, gire o seletor para a posição **DESLIGADO**. Em seguida, aguarde até que "Desligado" pare de piscar e recoloque o seletor na posição **REGAR**.

Os setores configurados para ignorar o sensor, bem como os programas de iluminação, irão funcionar normalmente durante um evento de espera clik.



NOTA: tenha cuidado ao usar a função de espera clik programável com os dispositivos Hunter Wind-Clik®, Freeze-Clik®, Soil-Clik e o componente de congelamento do Solar Sync e Rain/Freeze Clik, pois a espera clik ficará ativa APÓS um evento Clik desses dispositivos.

FUNÇÕES OCULTAS

Programação personalizada

O X-Core vem configurado de fábrica com três programas independentes (**A, B e C**), com quatro horários de início em cada um, para atender às necessidades de diferentes tipos de plantas. O X-Core pode ser personalizado para exibir apenas um programa e horário de início, ocultando programas e horários de início desnecessários para facilitar a programação.

1. Comece com o seletor na posição **REGAR** .
2. Segure o botão - . Gire o seletor para a posição **DIAS DE REGA** .
3. Solte o botão - .
4. Use os botões + e - para alterar os modos de programa.

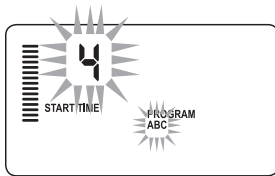

Modo normal
(3 programas / 4 horários de início)

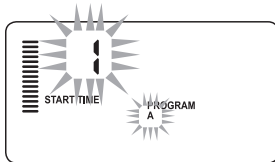

Modo limitado
(1 programa / 1 horário de início)

FUNÇÕES OCULTAS (CONTINUAÇÃO)

Ciclo e seca

A função de ciclo e seca permite dividir o tempo de rega de um setor em tempos menores e mais fáceis de usar. Ela é útil para declives ou solos com baixa capacidade de infiltração, já que a água é irrigada de forma mais lenta, evitando o escoamento. O tempo de ciclo deve ser uma fração do tempo de rega do setor, e o tempo de seca (absorção) deve ser o número mínimo de minutos necessários para que a rega possa voltar a ocorrer no ciclo seguinte. O número total de ciclos é determinado dividindo-se o tempo total da rega programado do setor pelo tempo de ciclo.

Acesso ao menu de ciclo e seca:

Para acessar a função de ciclo e seca, coloque o seletor na posição **REGAR**, segure o botão **+** por 3 segundos e, enquanto o botão **+** é pressionado, gire o seletor para a posição **TEMPOS DE REGA**, soltando o botão em seguida.

Ajuste do tempo de ciclo:

No início, será exibido o setor 1. Para acessar outros setores, pressione os botões ◀ ou ▶.

Quando o setor desejado for exibido, use os botões **+** ou **-** para aumentar ou diminuir o tempo de ciclo. O tempo pode ser ajustado de 1 minuto a 4 horas, em incrementos de 1 minuto, ou como **DESLIGADO**, se nenhum ciclo for necessário.



NOTA: para períodos menores do que 1 hora, somente os minutos serão exibidos (p. ex., 36). Para 1 hora ou mais, o visor passará a incluir o dígito da hora (p. ex., 1:13 e 4:00). Se o tempo de rega do setor for menor ou igual ao tempo de ciclo, nenhum ciclo será usado.

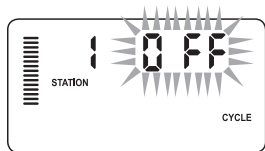

Exemplo de tela de ciclo no momento da programação

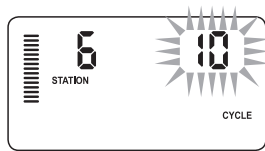

Exemplo de tela de ciclo somente com minutos

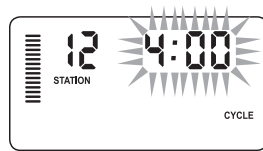

Exemplo de tela de ciclo com as horas incluídas

FUNÇÕES OCULTAS (CONTINUAÇÃO)

Acesso ao menu de seca:

Após os tempos de ciclo de cada setor serem programados, eles poderão ser acessados com o botão .

O setor permanecerá o mesmo exibido anteriormente no tempo de ciclo (ou seja, se o setor 2 estiver aparecendo no menu de ciclo, o setor 2 aparecerá quando o botão  for pressionado).





NOTA: o menu de seca não pode ser acessado se não houver um tempo de ciclo programado.

Ajuste do tempo de seca:

Para acessar outros setores, pressione os botões ◀ ou ▶.



NOTA: ao alterar os setores, se algum deles não tiver o tempo de ciclo, a tela voltará ao tempo de ciclo. Passe para o próximo setor com tempo de ciclo e pressione o botão  para retornar.

Quando o setor desejado for exibido, utilize os botões  ou  para aumentar ou diminuir o tempo de seca. O usuário pode configurar o tempo de seca de 1 minuto a 4 horas, aumentando o tempo através dos minutos.



NOTA: para períodos menores do que 1 hora, somente os minutos serão exibidos (p. ex., 36). Para 1 hora ou mais, o visor passará a incluir o dígito da hora (p. ex., 1:13 e 4:00).

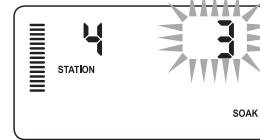

Exemplo de tela da função de seca somente com minutos



Exemplo de tela da função de seca com as horas incluídas

Situações da função ciclo e seca:

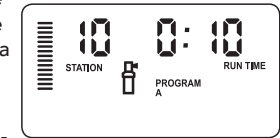

O setor 1 precisa de 20 minutos de rega, mas depois de 5 minutos ocorre um escoamento. Contudo, passados 10 minutos, toda a água é absorvida. A solução seria programar um tempo de rega de 20 minutos para o setor, um tempo de ciclo de 5 minutos e um tempo de seca de 10 minutos.

O tempo de seca ou absorção é um valor mínimo, e pode ser maior dependendo dos tempos de rega restantes.





Ciclo do setor 10 em execução

GUIA DE SOLUÇÃO DE PROBLEMAS

Problema	Causas	Soluções
O controlador está irrigando sem parar	Foram programados muitos horários de início	Basta um horário de início para acionar um programa (consulte "Configuração dos horários de início do programa" na página 18)
Nada aparece no visor	Nada aparece no visor	Corrija possíveis erros
O visor exibe a mensagem "Sem CA"	Não há alimentação CA (o controlador não recebe energia)	Verifique se o transformador está instalado corretamente
O visor exibe "Desligado,   "	O sensor de chuva está interrompendo a rega ou o jumper do sensor foi removido	Coloque o botão do sensor de chuva na posição para suprimir o circuito do sensor, ou reinstale o jumper
O sensor de chuva não desliga o sistema	<ul style="list-style-type: none"> • Sensor de chuva com defeito • O jumper não foi removido quando o sensor foi instalado • Os setores foram programados para suprimir o sensor 	<ul style="list-style-type: none"> • Verifique o funcionamento do sensor de chuva e a fiação • Remova o jumper dos terminais do sensor • Reprograme a supressão do sensor para ativar seu funcionamento (consulte a página 11)
Visor congelado ou mostrando informações incorretas	Oscilação de energia	Faça a redefinição do controlador seguindo as instruções da seção "Redefinição do controlador/Apagamento da memória", na página 24
O visor mostra "ERR" com um número de 1 a 8	Curto-circuito na fiação da válvula, ou solenoide com defeito no setor do número indicado	Verifique o circuito elétrico ou o solenoide da válvula do número indicado. Repare o curto-circuito ou troque o solenoide. Pressione qualquer botão para apagar "ERR" do visor
O visor mostra "P ERR"	<ul style="list-style-type: none"> • Defeito no relé da bomba ou na fiação da válvula mestre • Relé ou solenoide incompatível ou defeituoso • Fio com bitola insuficiente para o relé da bomba ou para a válvula mestre 	<ul style="list-style-type: none"> • Verifique a fiação até o relé ou o solenoide da válvula mestre. Pressione qualquer botão para apagar "P ERR" do visor • Verifique as especificações elétricas do relé da bomba. Não exceda as especificações elétricas do controlador. Substitua se estiver com defeito • Troque a fiação por outra mais grossa

GUIA DE SOLUÇÃO DE PROBLEMAS

Problema	Causas	Soluções
O visor mostra que um setor está irrigando, mas os símbolos  e  estão piscando	O sensor está interrompendo a rega, mas o setor foi programado para ignorar o sensor	Verifique o status da função de supressão do sensor (consulte a página 23)
A rega automática não começa no horário de início, e o controlador não está no modo Desligar Sistema	<ul style="list-style-type: none"> • O ajuste AM/PM (manhã/tarde) da hora do dia não está configurado corretamente • O ajuste AM/PM (manhã/tarde) do horário de início não está configurado corretamente • O horário de início está desabilitado (definido como Desligado) • O controlador não está recendo alimentação CA 	<ul style="list-style-type: none"> • Corrija o ajuste AM/PM da hora do dia • Corrija o ajuste AM/PM do horário de início • Consulte "Configuração dos horários de início do programa" (página 18) • Verifique as conexões da alimentação CA
O visor mostra traços quando o seletor está na posição "Configurações do Solar Sync"	<ul style="list-style-type: none"> • O sensor Solar Sync não está conectado ao controlador • Os fios do sensor Solar Sync podem estar rompidos ou ter uma conexão com problema 	Conecte o Solar Sync às posições "SEN" no terminal de ligações. O visor mostrará as configurações de região e ajuste de rega.
Os tempos de rega de um setor específico são muito curtos ou longos ao usar um sensor Solar Sync	O tempo de rega do programa está muito longo ou curto	O Solar Sync oferece um ajuste sazonal geral para o controlador. Se um setor específico tiver tempos de rega muito longos ou curtos, faça o ajuste adequado para o programa no controlador. Não se esqueça de recolocar o ajuste sazonal em 100% antes de alterar os tempos de rega do programa. Para fazer isso, gire o seletor para a posição Ajuste Sazonal e aumente ou diminua o valor até 100%.

GUIA DE SOLUÇÃO DE PROBLEMAS

Problema	Causas	Soluções
O ajuste sazonal parece baixo	<ul style="list-style-type: none"> • Configuração de região com número muito alto • Ajuste de rega muito baixo • A localização do sensor não permite ter uma exposição plena ao sol 	<p>Aumente o valor do ajuste de rega (o valor predefinido é 5)</p> <p>Se o valor do ajuste de rega já estiver no máximo (10) e mesmo assim você precisar de mais ajuste sazonal, altere a região para uma inferior (de 4 para 3, por exemplo) e comece com o ajuste de rega na posição 5. O Solar Sync atualizará imediatamente o ajuste sazonal no controlador. Se o resultado ainda for insuficiente, repita o ajuste até que o ajuste sazonal desejado seja mostrado no controlador.</p>
O ajuste sazonal parece alto	<ul style="list-style-type: none"> • Configuração de região com número muito baixo • Ajuste de rega muito baixo 	<p>Diminua o valor do ajuste de rega. Se o valor do ajuste de rega já estiver em 1 e você ainda precisar reduzir o ajuste sazonal, altere a região para uma superior (de 2 para 3, por exemplo) e comece com o ajuste de rega na posição 5. O Solar Sync atualizará imediatamente o ajuste sazonal no controlador. Se o resultado ainda for muito alto, repita o ajuste até que o ajuste sazonal desejado seja mostrado no controlador.</p>
O Solar Sync continua enviando o ajuste sazonal mesmo quando o botão de supressão do controlador está ativado	O ajuste sazonal automático do Solar Sync não pode ser desativado pelo botão de supressão. O botão controla apenas o desligamento das funções Rain/Freeze (chuva/congelamento) do Solar Sync	
Após remover o sensor Solar Sync, o ajuste sazonal não pode ser alterado manualmente	O sensor Solar Sync precisa ser desinstalado se for removido do controlador de forma permanente	Após remover o sensor Solar Sync do controlador, gire o seletor para as configurações do Solar Sync. O visor deverá mostrar linhas pontilhadas. Com isso, o sensor estará desinstalado.
O visor mostra "sem SS"	<ul style="list-style-type: none"> • O sensor Solar Sync foi desligado do controlador, mas não está desinstalado • As ligações por fio do Solar Sync têm um problema 	<ul style="list-style-type: none"> • Verifique as ligações por fio do Solar Sync ao controlador • Desinstale o Solar Sync se desejar desligá-lo permanentemente do controlador (consulte a pág. 14).

ESPECIFICAÇÕES

Especificações operacionais

- Tempos de rega dos setores: de 0 a 4 horas, com incrementos de 1 minuto
- 3 programas de rega independentes
- Horários de início: 4 por dia para cada programa, com um total de 12 inícios diários
- Programação de rega: calendário de 365 dias, rega em intervalos e rega em dias alternados
- Relógio com opções AM/PM ou 24 horas
- Operação manual simples
- Supressão do sensor por setor
- Atraso de rega programável (de 1 a 7 dias)
- Ajuste sazonal manual (de 10 a 150%)
- Botão de supressão do sensor

Dimensões

Gabinete para interior

- Altura: 16,5 cm
- Largura: 14,6 cm
- Espessura: 5 cm

Gabinete para exterior

- Altura: 22 cm
 - Largura: 17,8 cm
- Espessura: 9,5 cm

Especificações elétricas

- Entrada do transformador: 120 VCA $\pm 10\%$ 60 Hz
- (230 VCA $\pm 10\%$ 50/60 Hz, modelos internacionais)
- Saída do transformador: 24 VCA 1,0 A.
- Saída do setor: 0,56 A por setor.
- Saída máxima: 0,90 A (incluindo a válvula mestre).
- Bateria: de lítio de 3 V (incluída), usada para programação à distância e para manter a hora certa Utilize a CR2032 de 3 V.
- Proteção eletrônica contra curtos-circuitos
- Memória não volátil para dados dos programas

Legenda dos símbolos

~ = CA (corrente alternada)

 = Consultar documentação







 = Presença de tensão perigosa

 = Terra

İÇİNDEKİLER

X-CORE BİLEŞENLERİ	2	Sulamamın Yapılacağı Haftanın Belli Günlerini Seçme.....	20
KONTROL ÜNİTESİNİN DUVARA MONTAJI	6	Sulamada Tek veya Çift Günleri Seçme	20
VANALARIN VE ADAPTÖRÜN BAĞLANMASI	7	Aralıklı Sulama Seçimi 	20
PİLİN AKTİVE EDİLMESİ	8	Belirli Gün(ler)de Sulamayı Kapatma	20
PİLİN DEĞİŞTİRİLMESİ	8	Otomatik Sulama 	21
ANA VANA BAĞLANTISI	9	Sistemin Kapatılması 	21
POMPA START RÖLESİNİN BAĞLANMASI	10	Programlanabilir Yağmur Durdurması	21
HUNTER “CLİK” HAVA SENSÖRÜNÜN BAĞLANMASI	11	Mevsimsel Ayarlama %	21
Hava Sensörünün Test Edilmesi	11	Tek İstasyonu Manuel Çalıştırma 	22
Hava Sensörünün Manüel Olarak Atlanması	11	Tek Tuşla Manuel Başlatma ve İlerleme	22
HUNTER SOLAR SYNC ET SENSÖRÜNÜN BAĞLANMASI	12	GELİŞMİŞ ÖZELLİKLER	23
Solar Sync Sensörünün Montajı	12	Programlanabilir Sensor Atlatma	23
Kablosuz Solar Sync Sensörünün Montajı	12	Tüm İstasyonları Test Etme	23
Solar Sync Sensör Ayarları	12	Hunter Quick Check™ Kolay Kontrol Özelliği.....	23
Bölge 	13	Easy Retrieve™ Kolay Erişilebilen Hafıza	24
Su Düzeyi Ayarı 	14	Programlanabilir İstasyonlar Arası Gecikme	24
Solar Sync® Sensörün Çıkarılması	14	Hafızanın Temizlenmesi / Kontrol Ünitesinin Resetlenmesi	24
Kalibrasyon/Ayarlar	15	Clık Gecikme Hakkında Bilgiler	25
Solar Sync Gecikme Özelliği	16	Program Özelleştirme.....	26
HUNTER UZAKTAN KUMANDANIN BAĞLANMASI	17	Döngü ve İslatma	27
Hunter Uzaktan Kumanda (dâhil değildir) Montajı	17	ARIZA VE SORUN GİDERME REHBERİ	28
SmartPort Bağlantısının Eklenmesi	17	TEKNİK ÖZELLİKLER	31
GÜÇ ARIZALARI	17	İşletme Özellikleri	31
KONTROL ÜNİTESİNİN PROGRAMLANMASI	18	Elektrik Özellikleri.....	31
Tarih ve Saatin Ayarlanması 	18	Simgelerin Açıklanması.....	31
Program Başlangıç Zaman(lar)ını Ayarlama 	19	AVRUPA BİRLİĞİ DIREKTİFLERİNE UYUM BELGESİ	32
Program Başlangıç Zaman(lar)ını Silme.....	19		
İstasyon Çalışma Süresi Girme 	19		
Sulama Günlerini Seçme 	19		

X-CORE BİLEŞENLERİ

A LCD Display		
1	 Çalışma Süreleri	Kullanıcıya, her bir vana için 1 dakika ile 4 saat arasında çalışma süresi girme imkânı sağlar
2	 Başlangıç Zamanları	Her bir program için 1 ile 4 arasında başlangıç zamanı girilmesi imkânı sağlar
3	İstasyon Numarası	Seçili istasyon numarasını gösterir
4	Program Göstergesi	Hangi programın (A, B veya C) aktif olduğunu gösterir
5	Haftanın Günü	Haftanın gününü gösterir
6	Fasıllı Sulama	Tarihi ayarlarken geçerli ayı gösterir
7	Tek/Çift Gün Sulama	Tek veya çift gün sulamanın durumunu gösterir
8	Yanıp Sönen Rotor	Sulamanın aktif olduğunu gösterir
9	 Sistem Kapalı	Aktif olan tüm programın ve sulamanın durdurulmasına izin verir. Ayrıca kullanıcıya, sulamayı 1 ile 7 gün arasında durduran “yağmur durdurması” özelliğini aktif etme imkânı sağlar.
10	 Şemsiye	Yağmur sensörünün aktif olduğunu gösterir
11	Mevsimsel Ayarlama %	Kullanıcıya, kontrol ünitesini tekrar programlamadan mevsimlere göre çalışma zamanlarını ayarlama imkânı sağlar. Sol taraftaki çubuklar mevsimsel ayarlama yüzdesini görsel olarak ifade eder. Solar Sync ET Sensörü kullanılıyorken mevsimsel ayarların günlük olarak güncellenmesi sağlanır.
12	 Yağmur Damlası	Sulamanın seçili günde yapılacağını gösterir
13	 Çizili Yağmur Damlası	Sulamanın seçili günde yapılmayacağını gösterir
14	 Takvim	Sulama gün aralığının programlandığını gösterir. Ayrıca günü ayarlarken de simge ekranda gösterilir.

X-CORE BİLEŞENLERİ

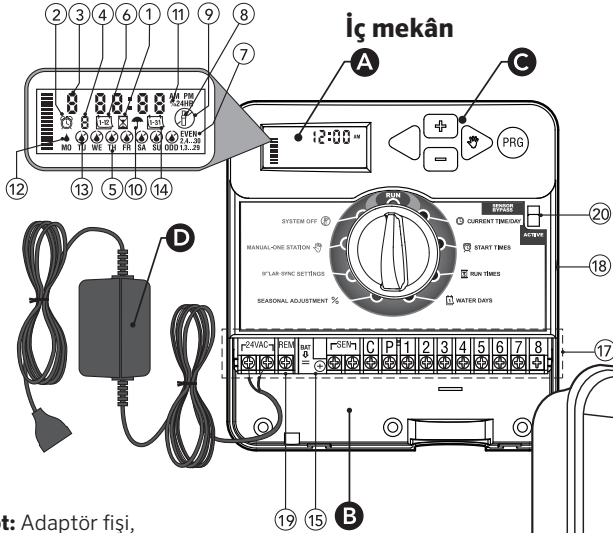

Not: Adaptör fişi, resimdekinden farklı olabilir.



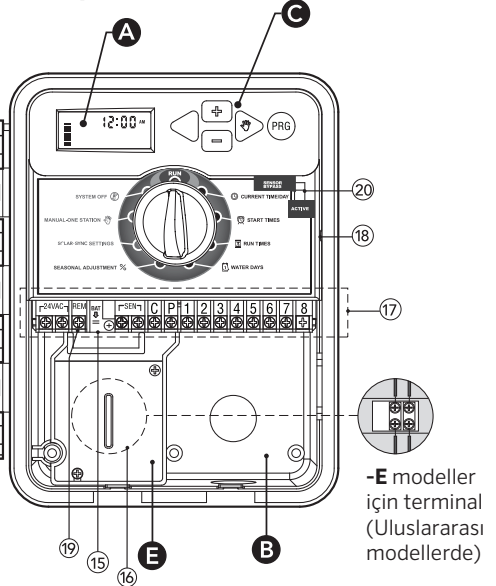



**Dış mekân
(Adaptör dahil edilmiştir.)**



X-CORE BİLEŞENLERİ

B Kabloleme Bölümü		
15	Lityum PİL	Değiştirilebilir lityum pil elektrik kaynağının yokluğunda da kontrol ünitesinin programlanmasına olanak tanır. Bunun yanı sıra, pil elektrik kesintilerinde güç sağlayarak ayarlanmış programların kaybolmasını engel olur.
16	Dâhili Buat Kutusu	Buat kutusu, dış mekân modellerinde AC güç kaynağı bağlantılarının yapılmasını sağlar
17	Terminaller	Adaptör, sensörler ve vanaların kablolanması için olanak tanır
18	Resetleme Tuşu	Kontrol ünitesinin resetlenmesi / yeniden ayarlanmasını sağlar (kontrol ünitesinin yan yüzünde)
19	REM	Hunter SmartPort® ve Hunter Uzaktan Kumanda bağlanabilmesini sağlar
20	Sensor Devre Dışı Tuşu	Devre dışı pozisyondayken hava sensörünün göz ardı edilmesini sağlar
C Kontrol Tuşları		
	+ Tuşu	Ekranı seçili verinin artırılmasını sağlar
	- Tuşu	Ekranı seçili verinin azaltılmasını sağlar
	◀ Tuşu	Ekranı seçili veriden bir öncekine atlar
	▶ Tuşu	Ekranı seçili veriden bir sonrakine atlar
	PRO Tuşu	Değişik sulama bölgelerinin ihtiyaçlarına göre A,B veya C programını seçer

X-CORE BİLEŞENLERİ

Kadran		
	Başlat	Kontrol Ünitesinin otomatik ve manuel çalıştırılması için normal pozisyonudur
	 Güncel Tarih/Zaman	Şu anki zaman ve günün ayarlanmasını sağlar
	 Başlangıç Zamanları	Her program için 1 ile 4 arasında başlangıç zamanı ayarlanmasını sağlar
	 Çalışma Süreleri	Her bir vana istasyonunun 1 dakika ile 4 saat arasında çalışmasını sağlar
	 Sulama Günleri	Sulama arasındaki gün aralıklarının belirlenmesini sağlar
	Mevsimsel Ayarlama %	Mevsime göre program değerlerini değiştirmeden sulama süresinin değiştirilmesini sağlar. Sol taraftaki çubuklar mevsimsel ayarlanmanın görsel olarak yüzdelerini gösterir.
	 Manuel Tek İstasyon	Tek bir vana için bir kez sulama yapılmasını sağlar
	 Sistem Kapalı	Tüm programların ve sulamanın kapatılmasını sağlar. Ayrıca programlanabilir sulama kesilmesi ile 1 - 7 gün arasında sulamanın durdurulmasını sağlar.
	SOLAR SYNC® Ayarları	Solar Sync ET Sensör ile program ayarlarının yapılmasını sağlar
D Harici Adaptör (Sadece İç mekân Modellerde)		
		Adaptör ile kontrol ünitesinin şebeke elektriği ile kullanılmasını sağlar

KONTROL ÜNİTESİNİN DUVARA MONTAJI



NOT: İç mekân X-Core, su ve hava koşullarına dayanıklı değildir. Bu sebeple iç mekâna ya da korunaklı yerlere monte edilmelidir.

1. Bir vidayı duvara sabitleyin. Gerekliyse vidalama sırasında dübel kullanılmalıdır.
2. Kontrol ünitesinin üst kısmındaki deliğinden vidaya asın.
3. Terminallerin altındaki delikten vidalayarak üniteyi nihai olarak sabitleyin.



NOT: Kontrol ünitesinin montajı ve vana bağlantıları tamamlanmadan ünitenin adaptörünü kesinlikle prize takmayınız.



NOT:XC -x01 - A için: Besleme kablosu hasar görürse, olası tehlikeyi engellemek için üretici firma, servis elemanı veya benzer düzeyde kalifiye personel tarafından değiştirilmelidir.



NOT:Maksimum oranda suya dayanım için dış mekan ünitelerde kapağın kapalı kalması gerekir.

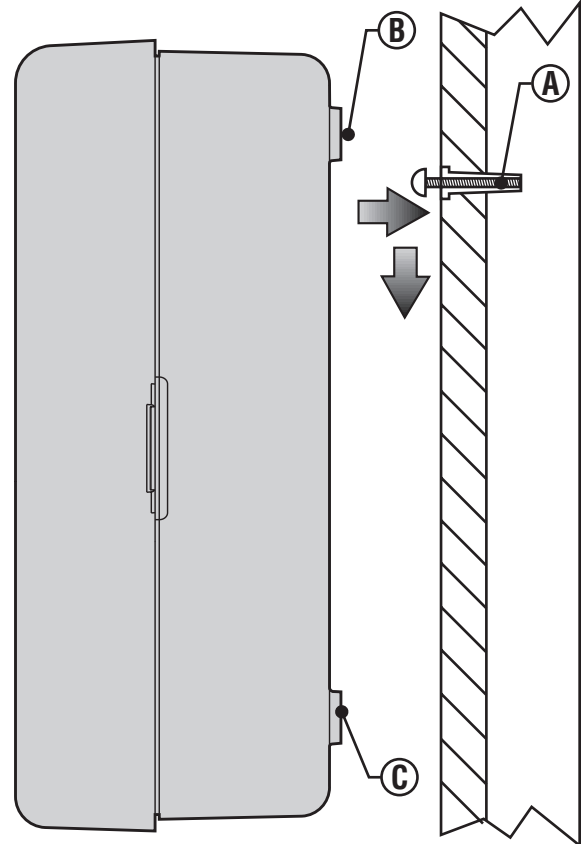

VANALARIN VE ADAPTÖRÜN BAĞLANMASI

X-Core montajı, eğitimli bir kişi tarafından yapılmalıdır.

1. Vana kablosunu vanadan kontrol ünitesine kadar çekin.
2. Vanalarda, ortak-(common) kablosunu, solenoid üzerindeki kablolarından birine bağlayın. Genellikle beyaz kablo kullanılır. Farklı bir kontrol kablosunu her bir vana üzerinde kalan diğer kabloya bağlayınız. Bütün kablo bağlantılarınızı su geçirmez birleştiriciler ile güvence altına alın.
3. Vana kablolarını, kablo borusundan geçirin ve borunun bir ucunu kontrol ünitesinin sağ altındaki boşluktan içeri sokun.
4. Beyaz olan ortak kabloyu C (Common - Ortak) terminal vidasına bağlayın. Her biri bağımsız vana kontrol kablolarından uygun terminal vidasına bağlayın ve vidaları iyice sıkın.
5. İç Mekân Modeller: Adaptörün kablosunu kontrol ünitesinin solunda bulunan delikten geçirin ve 24 VAC ibareli vidalara sarın.

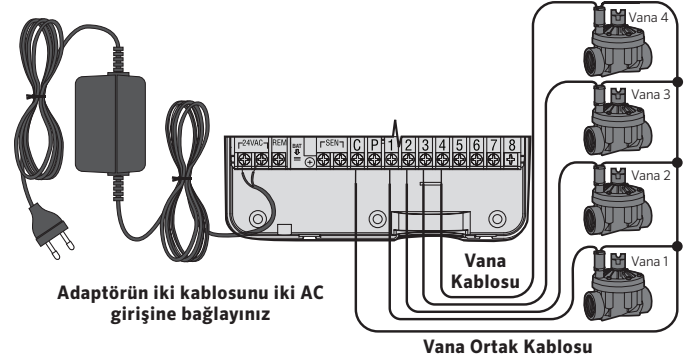

NOT: Kontrol ünitesinin içindeki transformatör kablosu kesilmemelidir. Kablo kesilirse kablodaki kırmızı ve beyaz kablolar, birleştirilmelidir. Aksi halde, kontrol ünitesi çalışmayacaktır.

Dış Mekân Modeller: Adaptör kablosu üretim sırasında üniteye bağlanmıştır. Yapılması gereken güç kaynağına bağlantının yapılmasıdır (Yana Bakınız).



NOT: X-Core dış mekân kontrol üniteleri su ve hava koşullarına dayanıklıdır. Dış mekân kontrol ünitesinin şebeke elektriğine bağlanması bir elektrikçi tarafından yapılmalıdır. Hatalı bağlantılar elektrik çarpması ve yangın tehlikesi yaratır.

E Yüksek Voltaj Kablolaması (Sadece Dış Mekân Modellerde)

1. AC güç kablosunu ilerletin ve kabinin sol alt tarafını açarak ½" (13 mm) kablo koruma borusunu deliğin içinden geçirin.
2. Kablolardan birini bağlantı kutusu içindeki iki kablodan birine bağlayın. Topraklama hattı yeşil kablo ile bağlanmalıdır. Kablo vidaları bağlantının yapılabilmesi için kutuya dahil edilmiştir.
Not: -E Modellerde: Kablo bağlantı kutusu içinde bulunan AC terminaline kabloları bağlayın. AC terminal kabloları kablo ebatlarına uygun sigorta ile beraber 14 AWG (1.85 mm) veya daha geniş kablodan seçilmelidir. Bir devre kesici veya sigorta (kullanıcının kolaylıkla ulaşabileceği tercihen kontrol ünitesi yakınında) tesisatın uygulama esnasında dahil edilmeli ve ünitenin bağlantı kesme aparatı olarak belirtilmelidir.
3. Kablo bağlantı kutusunu yerine takınız.

PİLİN AKTİVE EDİLMESİ

X-Core montajını yaptıktan sonra, elektrik kesilmelerinde saatin ve tarihin kaybolmaması için, pilin yalıtkan plastiğinin çıkarıldığından emin olunuz.



Dikkat:
Pilin yanlış bir pil ile değiştirilmesi sonucu patlama riski oluşabilir. Kullanılmış pili talimatlara göre imha ediniz.

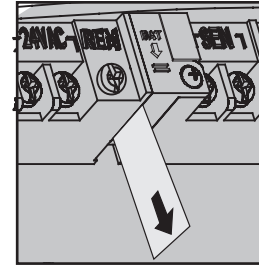

PİLİN DEĞİŞTİRİLMESİ

Yüksek enerjili lityum bir pil X-Core kontrol ünitenize dâhil edilmiştir. Bu pil, AC güç olmadan da kontrol ünitesinin programlanmasına olanak tanır. Ayrıca elektrik kesintilerinde güncel zaman ve tarihin korunmasında kullanılır.

Pili değiştirmek için:

1. Pil yuvasındaki vidayı sökün.
2. Pile ulaşmak için yuvayı kaydırarak çıkarın.
3. Pili değiştirin ve pil yuvasını yerine takın.



NOT: Pilin artı (+) yönü yuvanın iç kısmına bakmalıdır.

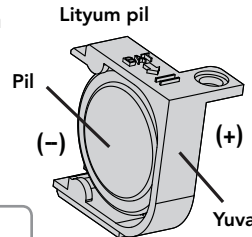

Pil tipi: CR2032 3V

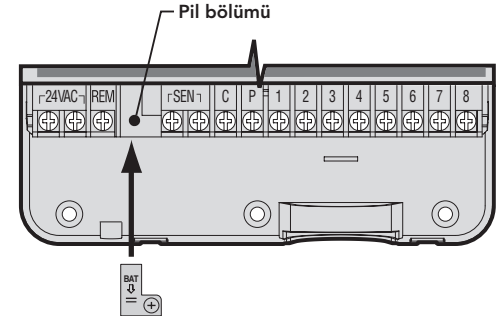

ANA VANA BAĞLANTISI



NOT: Bu bölüm sadece sulama sisteminizde ana vananız olacaksa incelenmelidir. Ana vana, ana hattın destek noktasında, “normalde kapalı” bir vanadır ve yalnızca kontrol ünitesi sulama programını başlattığında açılır.

1. Vana ortak kablosunu vananın solenoid kablolarından birine bağlayın. Farklı bir kontrol kablosunu, solenoidin kalan diğer kablosuna bağlayın.
2. Ortak kablo kontrol ünitesindeki **C** terminaline bağlanmalıdır. Ana vanadan gelen diğer kablo kontrol ünitesindeki **P** terminaline bağlanmalıdır. Terminal vidaları bağlantıdan sonra iyice sıkılmalıdır.

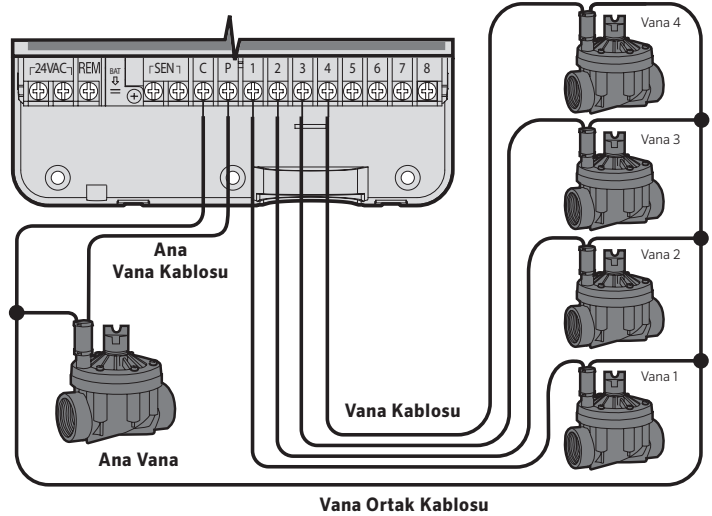

POMPA START RÖLESİNİN BAĞLANMASI



NOT: Bu bölüm sadece sisteminizde pompa start röleniz ve pompanız varsa incelenmelidir. Pompa start rölesi kontrol ünitesinden gelen sinyalle, sisteminize suyu sağlayan pompayı çalıştırmak için ayrı bir elektrik devresini aktive eden cihazdır.

Herhangi bir potansiyel elektrik engeli minimize etmek için kontrol ünitesi pompa start rölesinden ve pompadan en az 4,5 m. (15 ft.) uzağa monte edilmelidir.

1. Bir çift kabloyu pompa rölesinden kontrol ünitesine uzatın.
2. Ortak kabloyu kontrol ünitesindeki **C** (Common - standartta beyaz kablo) ve pompa start rölesinden gelen diğer kabloyu **P** (Pump - Pompa) terminaline bağlayın.

Röle, 30 amperden büyük olmamalıdır. Kontrol ünitesini kesinlikle direkt olarak pompaya bağlamayınız, bu kontrol ünitesinde bir arıza ile sonuçlanacaktır.

<http://www.hunterindustries.com/support/controllers/pump-start-relay>

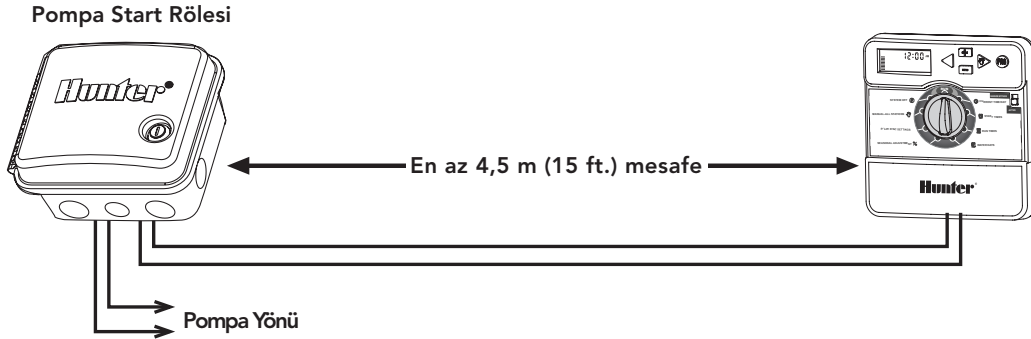

HUNTER “CLIK” HAVA SENSÖRÜNÜN BAĞLANMASI

Hunter hava sensörü veya diğer mikro-switch tip hava sensörler, X-Core kontrol ünitesine bağlanabilir. Bu sensörlerin görevi, hava koşullarının uygun olmadığı zamanlarda otomatik sulamanın durdurulmasıdır.

1. Kontrol ünitesinin iç kısmında bulunan SEN terminalerini birbirine bağlayan **metal plakayı** çıkarın.
2. Sensörden gelen kablolardan birini SEN terminaline diğer kabloyuda diğer SEN terminaline bağlayınız.

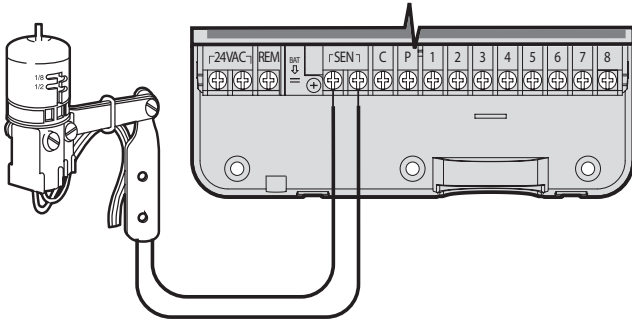

Hava sensörü otomatik sulamayı durdurduğunda ekranda **OFF** yazısı ve (☂) şemsiye simgesi belirecektir.



Hava Sensörünün Test Edilmesi

X-Core, sensör, sensör devresine kablolandığında yağmur sensörünün kolaylaştırılmış testinin yapılabilmesini sağlar. **OTO DÖNGÜ**'yü aktive ederek veya **Tek Tuşla OTO DÖNGÜ**'yü aktive ederek, yağmur sensörünün çalışmasını kontrol edebilirsiniz (sf:22 bakınız). Manüel sulama esnasında, Hunter sensörünün üzerindeki butona basıldığında sulama durdurulacaktır.

Hava Sensörünün Manüel Olarak Atlatılması

Eğer yağmur sensörü sulamayı kesiyorsa kontrol ünitesinin ön yüzünde bulunan by pass tuşu ile sensörü atlatılabilir. Yağmur sensörünü sistemden ayırmak ve kontrol ünitesini çalıştırmak için tuşu **SENSÖR BYPASS** pozisyonuna kaydırın. **MANUEL TEK İSTASYON** fonksiyonunu kullanırsanız, kontrol ünitesi, seçilen zaman dilimi için, sensör girişlerini otomatik olarak baypas edecektir. Tamamlandığında, kontrol ünitesi seçilen ayarlara geri dönecektir.



NOT: Sensör Bypass anahtarını etkinleştirmenin, Solar Sync sensöründen gelen mevsimsel ayar güncellemelerine etkisi olmaz. Sensörün yalnızca Rain Click ve Freeze - Click fonksiyonlarını baypas edecektir.

HUNTER SOLAR SYNC ET SENSÖRÜNÜN BAĞLANMASI

X-Core Solar Sync ve kablosuz Solar Sync sistemleri ile uyumludur. Solar Sync, Mevsimsel Ayarlama özelliğini kullanarak X-Core kontrol ünitesinde sulama programını otomatik olarak ayarlayan (yerel iklim durumlarındaki değişime göre) sensör sistemidir. Solar Sync, güneş ışığı ve sıcaklık sensörlerini kullanarak evapotranspirasyonu (ET - buharlaşma) veya bitki ve çimin su ihtiyaç oranını belirler ve ayrıca Hunter Yağmur Sensörü ve Don Sensörü teknolojisi ile yağmur ve/veya don durumlarında sulamayı kesen sistemdir.



NOT: Solar Sync, sensörden bir tam gün (24 saatlik period) boyunca ölçümlerinin alınmaya kadar mevsimsel ayarını fabrika ayarı olan 100% oranında uygular.



NOT: Sensör Bypass tuşunun, Solar Sync sensöründen gelen mevsimsel ayar güncelleştirmeleri üzerinde hiçbir etkisi yoktur. Ancak Yağmur Sensörü ve Don Sensörü özelliklerini kapatır. (bypass eder)



NOTE: X-Core Kontrol Ünitesini kullanırken kurulum için Solar Sync modülü gerekmemektedir.

Solar Sync Sensörünün Montajı

Solar Sync Sensörü'nden gelen yeşil ve siyah kablolar 11. sayfadaki resimde gösterildiği gibi X-Core'daki "SEN" terminaline bağlanır. Hangi kablunun hangi vidaya bağlandığının önemi



yoktur. Kadranı Solar Sync Ayarları pozisyonuna çevirin. Ekranda kısa çizgiler ve solda fabrika ayarı olan üçüncü bölge (3) ile sağda fabrika ayarı olan su düzeyi beş (5) belirecektir. Eğer gerekiyorsa bölge ayarını ünitedeki ▲ ve ▼ tuşları ile (sayfa 13'de Solar Sync Bölge ayarlarında açıklandığı gibi) değiştirin. ► tuşunu sağ tarafa geçiş gerekiyorsa su düzeyi ayarını (sayfa 14'de Solar Sync Su Düzeyi ayarında gösterildiği gibi) yapmak için kullanın.

Kablosuz Solar Sync Sensörünün Montajı

Kablosuz Solar Sync Sensör alıcısından gelen yeşil ve siyah kablolar X-Core'daki "SEN" terminaline bağlanır. Hangi kablunun hangi vidaya bağlandığının önemi yoktur. Kadranı Solar Sync Ayarları pozisyonuna çevirin. Ekranda kısa çizgiler ve solda fabrika ayarı olan üçüncü bölge (3) ile sağda fabrika ayarı olan su düzeyi beş (5) belirecektir. Eğer gerekiyorsa bölge ayarını ünitedeki ▲ ve ▼ tuşları ile (sayfa 13'de Solar Sync Bölge ayarlarında Açıklandığı gibi) değiştirin. ► tuşunu Sağ tarafa geçiş gerekiyorsa su düzeyi Ayarını (sayfa 14'de Solar Sync Su Düzeyi Ayarında gösterildiği gibi) yapmak için kullanın.



Solar Sync Sensör Ayarları

Solar Sync sensörü X-Core kontrol ünitesine bağlıyken kadran Solar Sync Ayarları pozisyonuna getirildiğinde ekranda iki rakam belirir. Ekranın solundaki rakam Bölge ayarını ve ekranın sağındaki rakam Su Düzeyi ayarını (diğer sayfada gösterildiği gibi) belirtir.

HUNTER SOLAR SYNC ET SENSÖRÜNÜN BAĞLANMASI

Bölge

Doğru Solar Sync ölçümleri için kontrol ünitesi, bölgenizdeki ortalama pik sezon (evapotranspirasyon) ET değerlerine göre programlanması gerekir. Bölgenizi saptamak için aşağıdaki tabloyu kullanabilirsiniz.

Tablo, yaşadığınız bölgenin tipini belirlemenizi sağlar. Her birinin özellikleri, tipik ET ve sıcaklık karakteristikleri yazan dört temel ET bölgesi mevcuttur. Eğer mümkünse bölge ortalama Temmuz ayındaki ET değeri veya yaz ET pikine bakılarak seçilmesi tavsiye edilir.

Aşağıdaki tabloyu bölgenizi belirlemek için kullanabilirsiniz. **A, B** veya **C** metodlarını kullanarak hangi bölgenin bulunduğunuz yere en uygun olduğunu tespit edebilirsiniz:

- A:** Bölgenizdeki ET değerinden Temmuz ayı **ortalaması** veya yaz ayındaki en yüksek ET değerini kullanabilirsiniz. Bölgenizi belirlemedeki önerilen yöntem budur.
- B:** Bölgenizdeki sıcaklık değerinden Temmuz ayı **ortalaması** veya en kuru aydaki en yüksek sıcaklığı (Temmuz ayı en yüksek sıcaklığı olmamalıdır) kullanabilirsiniz.
- C:** Bölgenize uygun tanımlamayı kullanabilirsiniz.

BÖLGE TİPİNİZİ BELİRLEMEK İÇİN SATIRLARDA BULUNAN ÖZELLİKLERDEN BİRİNİN KARŞILAMASI GEREKMEKTEDİR.

	A	B	C
1 Bölge	Temmuz ayı ET ortalaması < 4,13 mm / gün	Temmuz ayı sıcaklık ortalaması 18°C – 24°	Sahil Bölgeleri
2 Bölge	Temmuz ayı ET ortalaması 4,6 mm – 5,8 mm / gün	Temmuz ayı sıcaklık ortalaması 24°C – 29°C	Dağlık Bölgeler
3 Bölge	Temmuz ayı ET ortalaması 6,1 mm – 7,4 mm / gün	Temmuz ayı sıcaklık ortalaması 29°C – 35°C	Karasal bölgeler ve yüksekte kalan çöller
4 Bölge	Temmuz ayı ET ortalaması > 7,6 mm / gün	Temmuz ayı sıcaklık ortalaması 35°C – 41°C	Çöller

HUNTER SOLAR SYNC ET SENSÖRÜNÜN BAĞLANMASI

Su Düzeyi Ayarı ↑↓



Su Düzeyi Ayarı, 1 ile 10 arasındaki ölçekte Solar Sync Sensörü'nden alınan Mevsimsel Ayarlama değerinin kolaylıkla belirlenmesini sağlar. Solar Sync ET Sensörü'nün montajını takiben Su Düzeyi ayarının varsayılan değer olan 5'te kalması önerilir. Ne var ki montaj sonrası, mevsimsel ayarın beklenenden düşük ya da yüksek olduğunu fark ederseniz su düzey ayar değeri Mevsimsel Ayarlama çıktı değerini ayarlayabilmek için değiştirilebilir. Su Düzeyi Ayarı ölçeği ile mevsimsel ayarın hassas olarak nasıl ayarlayacağınızı Sayfa 15'de bulunan Kalibrasyon / Ayar açıklamasından yararlanarak öğrenebilirsiniz.



NOT: Eğer bir bölge, sistemin diğer bölgelerine kıyasla “daha ıslak” veya “daha kuru” ise kontrol ünitesindeki çalışma süresini azaltabilir veya arttırabilirsiniz.

Solar Sync Sensörünün Çıkarılması

Eğer bir Solar Sync sensörü X-Core kontrol ünitesine bağlanmışsa kontrol ünitesinin uyguladığı mevsimsel ayar değeri Solar Sync sensöründen alınan hava bilgileri ile ayarlanır. Eğer Solar Sync sensörün X-Core kontrol ünitesi ile kullanılmamasına karar verildiyse mutlaka sistemden kaldırılmalıdır. **Eğer Solar Sync sensörü sistemden kaldırılmazsa kontrol ünitesi mevsimsel ayarın elle girilmesine izin vermeyecektir.** Örneğin, eğer Solar Sync sensör söküldüğünde kontrol ünitesindeki mevsimsel ayar %50 değerine kalmış ise Solar Sync sensörü sistemden silinmedikçe %50 değerini korumaya devam edecektir.

Solar Sync sensörü kaldırmak için yeşil ve siyah kablolar kontrol ünitesinin terminalinden sökülmeli ve kadran “Solar Sync Ayarları” konumuna alınmalıdır. Ekranda kontrol ünitesinin, mevsimsel ayarları yapmak için Solar Sync sensörden veri alamadığına dair kısa çizgiler görülür. Bundan sonra kadran “Mevsimsel Ayarlama” çizgisine alınarak ve ,  tuşları kullanılarak mevsimsel ayar değeri arzu edilen seviyeye getirilebilir.

HUNTER SOLAR SYNC ET SENSÖRÜNÜN BAĞLANMASI

Kalibrasyon / Ayarlar

Solar Sync bağlandıktan ve ayarlandıktan sonra, sistemin birkaç gün boyunca kendiliğinden çalışarak veri toplamasına olanak verilmesi önerilir. Çünkü sahadaki koşulların farklılıklar (sensör konumu, sensöre düşen direk gün ışığı miktarı, çevredeki cisimlerden yansıyan ısı vb.) nedeniyle, **arzu edilen performansla ulaşabilmek için başlangıç ayarlamalarında düzeltmeler yapılması gerekebilir.** Solar Sync'in kalibrasyonu Bölgesel ve/veya Su Düzeyi Ayarı ile kolaylıkla yapılabilir. Bu işlemler aşağıda açıklanmıştır:

1. Solar Sync sensörü bağlayın
2. Bölgeyi belirleyin ve sistemin en az 3 gün boyunca ilk ayarları yapması için çalışmasını sağlayın (sayfa 13'de bulunan yönergeler Bölge'yi doğru şekilde nasıl tain edeceğinizi anlatmaktadır).
3. Kontrol ünitesindeki Mevsimsel Ayarlamayı gözleyin. Eğer Mevsimsel Ayarlama, yılın o zamanı için beklenenden düşük ya da yüksek kalıyorsa Solar Sync ayarlarını düzeltmek gerebilir.
 - a. **Mevsimsel Ayarlama çok düşük:** Kadranı Solar Sync Ayarları pozisyonuna getirin. Su Düzeyi ölçeğindeki değeri arttırın (10 en yüksek). Ayar değiştirildikten sonra kontrol ünitesi Mevsimsel Ayarlama yüzdesini yeni değere göre yenileyecektir. Su Düzeyi değerini istenilen Mevsimsel Ayarlama yüzdesi görülünceye kadar arttırın. **Eğer Su Düzeyini maksimum seviye olan 10 değerine getirdiğiniz halde halen mevsimsel ayarlamayı arttırmamız gerekiyorsa Bölgesel ayarı bir dilim aşağı indiriniz gerekmektedir (örneğin 4. Bölge'den 3. Bölge'ye).**
 - b. **Mevsimsel Ayarlama çok yüksek:** Kadranı Solar Sync Ayarları pozisyonuna getirin. Su Düzeyi ölçeğindeki değeri azaltın (varsayılan değer 5). Ayar değiştirildikten sonra kontrol ünitesi Mevsimsel Ayarlama yüzdesini yeni değere göre yenileyecektir. Su Düzeyi değerini istenilen Mevsimsel Ayarlama yüzdesi görülünceye kadar azaltın. **Eğer Su Düzeyini minimum seviye olan 1 değerine getirdiğiniz halde halen mevsimsel ayarlamayı azaltmanız gerekiyorsa Bölgesel ayarı bir dilim yukarı çıkarmanız gerekmektedir (örneğin 2. Bölge'den 3. Bölge'ye).**

İstasyon Çalışma Süresi: Solar Sync'in genel bir mevsimsel ayarlama yaptığını anlamanız oldukça önemlidir. Bu da tüm istasyonların çalışma süresinin mevsimsel ayar yüzdesine göre modifiye edilmesi demektir. Kontrol ünitesi programlanırken çalışma süreleri, en yüksek sezondaki sulama takvimine uygun şekilde yapılmalıdır. Eğer Solar Sync ayarları mevcut sezon değeri göz önüne alınarak yapıldığında belirli bir istasyondaki çalışma süresi çok uzun ya da kısa oluyorsa istasyonun çalışma süresini tekrar programlamak gerekmektedir.

SOLAR SYNC GECİKME ÖZELLİĞİ

X-CORE® için Solar Sync Gecikmesi

Gecikme özelliğine sadece Solar Sync'in kurulumundan sonra erişim sağlanır. Solar Sync Gecikme özelliği kullanıcıya Solar Sync'ten yapılan mevsimsel ayar değişikliklerini 99 güne kadar geciktirmeye imkan sağlar.

Solar Sync aktif olduğunda, Solar Sync bilgi toplamaya ve saklamaya devam edecektir.

İşlem:

Solar Sync Gecikme ayarlarına ulaşmak için:

1. Kadranı Başlat konumuna getirin; **+** tuşunu basılı tutun, kadranı Solar Sync konumuna gelene kadar çevirin ve sonra **+** tuşunu bırakın. Belirecek ekran şöyle olacaktır: **d:XX** (d günleri ve **XX** gecikme olacak gün sayısını belirtmektedir)
2. Gecikmenin devam etmesini istediğiniz gün sayısını **+** veya **-** tuşlarına basarak arttırıp azaltabilirsiniz. Arzulanan gün sayısına varıldığında, gecikmeyi aktive etmek için kadranı tekrar Başlat konumuna geri getirin.



NOT: Kalan gün sayısı Başlat ekranında belirmeyecektir. Gecikme özelliğinin aktif olduğunu kontrol etmek için Solar Sync Gecikme menüsünü açınız ve beliren günü kontrol ediniz. 1 veya daha fazla gün beliriyorsa, o zaman Solar Sync Gecikmesi aktif demektir, eğer 00 beliriyorsa, o zaman Solar Sync aktif değildir.

Mevcut Gecikme gün ayarlarını değiştirmek için:

1. **+** tuşuna basarak ve kadranı Solar Sync Ayarları konumuna getirerek Solar Sync Gecikme menüsünü açınız ve **+** tuşuna basmayı bırakınız
2. Arzulanan gecikme gün sayısı belirene kadar, gün sayısını + veya - tuşlarını kullanarak değiştirin.
3. Yaptığınız değişikliklerin aktif hale gelmesi için kadranı Başlat konumuna geri getirin.

Solar Sync Gecikmesi aktif olduğunda, Solar Sync hava durumu bilgisi toplamaya ve Mevsimsel Ayarlama Değerini hesaplamaya devam edecektir. Güncellenen mevsimsel ayar, Solar Sync Gecikme günleri 00'a ulaştığında uygulanacaktır.

HUNTER UZAKTAN KUMANDANIN BAĞLANMASI

Hunter Uzaktan Kumanda (dâhil değildir) Montajı

X-Core kontrol ünitesi Hunter Uzaktan Kumandalar (dâhil değildir) ile uyumludur. SmartPort® bağlantısı (tüm Hunter uzaktan kumandalarda bulunur) hızlı ve kolay bir şekilde Hunter kontrol ünitelerinin kullanılmasını sağlar. Hunter uzaktan kumandaları, kontrol ünitesine gidip gelmeden sistemi yönetmenize olanak tanır.

SmartPort Bağlantısının Eklenmesi

1. X-Core'un kablolama bölümünün yaklaşık 12 inç altına ½" ölçüsünde dişi dişi "Tee" koyun. (ürüne dahil değildir).
2. Şekilde gösterildiği gibi kırmızı, beyaz ve mavi kabloları Tee parçasının altından besleyerek kontrol ünitesinin kablolama bölümüne geçiriniz.
3. SmartPort pasosunu şekildeki gibi Tee parça içine sabitleyiniz.

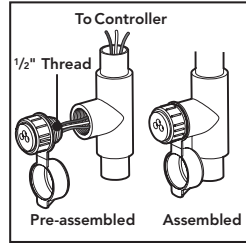

4. Kırmızı, beyaz ve mavi SmartPort kablolarını kontrol ünitesindeki terminallere aşağıda gösterildiği gibi bağlayınız:
 - Kırmızı kablo "24VAC" terminalinin soluna
 - Beyaz kablo "24VAC" terminalinin sağına
 - Mavi kablo "REM" terminaline

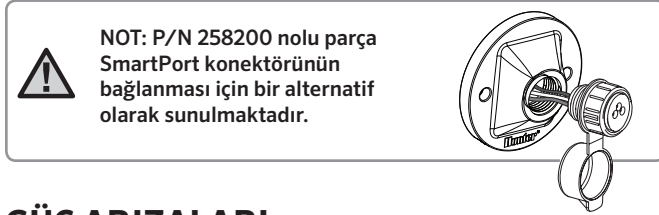
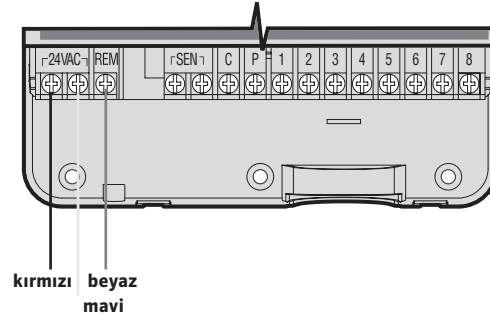

GÜÇ ARIZALARI

Güç arızaları ihtimali nedeniyle kontrol ünitesi silinmeyen hafızaya sahiptir. Programlanmış bilgiler elektrik kesintisiyle hiçbir zaman kaybolmaz. Lityum pil AC güç olmasa bile zamanı doğru bir şekilde tutar. Normal sulama AC gücün gelmesiyle devam eder.

KONTROL ÜNİTESİNİN PROGRAMLANMASI

X-Core ekranı rölanti modunda saati ve günü gösterir. Kadran döndürüldüğünde ekrandaki görüntü, o anki ayarın yapılacağı bilgileri gösterecek şekilde değişir. Programlama yapılırken ekrandaki yanıp sönen kısım **+** veya **-** tuşlarına basarak değiştirilebilir. Yanıp sönmeyen herhangi bir değeri değiştirmek için ilgili bölgeye gelene kadar **◀** veya **▶** tuşlarına basın.

Her biri dört başlangıç zamanına sahip olan A, B ve C programları, farklı sulama takvimi uygulamasına izin verir.

Tarih ve Saatin Ayarlanması 🕒

1. Kadranı GÜNCEL TARİH/ZAMAN pozisyonuna getirin.
2. Güncel yıl yanıp sönmektedir. **+** veya **-** tuşlarına basarak yıl değiştirilebilir. Yılı ayarladıktan sonra **▶** tuşuna basarak ay seçimine geçin.
3. Ay ve gün ekranda görünecektir. Ay yanıp sönerken ekranda takvim simgesi gözükür. **+** veya **-** kullanarak ayı değiştirilebilir. **▶** tuşuna basarak gün ayarlanmasına ilerleyin.
4. Gün yanıp sönmekte ve ekranda takvim simgesi gözükmemektedir. **+** veya **-** tuşlarına basarak gün değiştirilebilir. **▶** tuşuna basarak zaman seçimine geçin.
5. Ekranda zaman gözükür. **+** veya **-** tuşlarını kullanarak AM, PM veya 24 saat arasında seçim yapılabilir. **▶** tuşuna basarak saat seçimine geçin. Saat yanıp sönmektedir. **+** veya **-** kullanarak saat değiştirilebilir. **▶** tuşuna basarak dakika seçimine geçin. Dakika yanıp sönmektedir. **+** veya **-** kullanarak dakika değiştirilebilir. Tarih, gün ve zaman şimdi ayarlanmıştır.



NOT: En temel programlama kuralı hangi sembol ya da karakter yanıp sönyorsa onun programlandığıdır. Örneğin, zaman ayarı yapılırken saat yanıp sönyorsa saat değiştirilir ya da programlanabilir. Bu kılavuzda yanıp sönen karakterler her zaman GRİ resmedilmiştir.

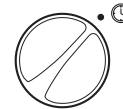



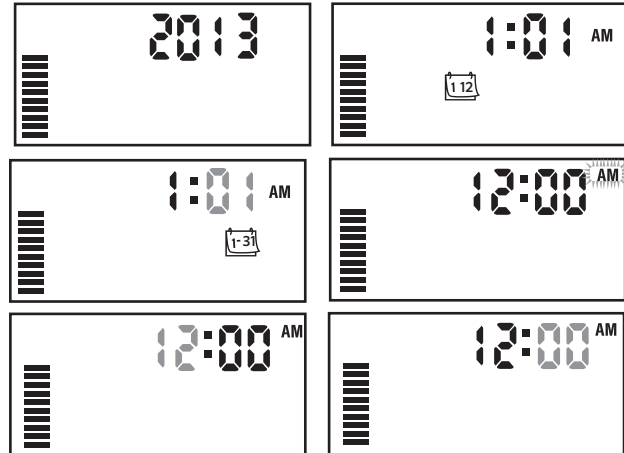

GÜNCEL SAAT/TARİH - GÜNCEL SAAT/TARİH



KONTROL ÜNİTESİNİN PROGRAMLANMASI



Program Başlangıç Zaman(lar)ını Ayarlama

1. Kadranı **BAŞLANGIÇ ZAMANLARI** pozisyonuna getirin.
2. Varsayılan olarak A programı gelir. Eğer gerekliyse  tuşuna basarak B veya C programı seçebilirsiniz.
3.  veya  tuşlarını kullanarak başlangıç zamanını (15 dakika artımlarla) değiştirin.
4.  tuşuna basarak ilave bir başlangıç zamanı girebilir ya da  tuşuna basarak diğer programa geçebilirsiniz.







NOT: Tek bir başlangıç zamanı o programdaki tüm istasyonları sırasıyla aktive edecektir. Bu sayede her istasyon için yeniden başlangıç zamanı girmeye gerek kalmamaktadır. Bir program içindeki çok sayıda başlangıç zamanları; farklı sabah, öğle veya akşam döngüleri oluşturur. Başlangıç zamanları herhangi bir sırayla girilebilir. X-Core otomatik olarak sıralayacaktır.

Program Başlangıç Zaman(lar)ını Silme

Kadran **BAŞLANGIÇ ZAMANLARI** pozisyonundayken saati  veya  tuşlarıyla 12:00 AM (gece yarısı) getirin.  tuşuna bir kez daha basarak kapatabilirsiniz. İkinci başlangıcı önlemek için sağ taraftaki oka basınız.



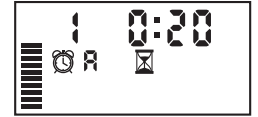

İstasyon Çalışma Süresi Girme

1. Kadranı **ÇALIŞMA SÜRELERİ** pozisyonuna getirin.
2. Ekranda en son seçili program (A, B, veya C), seçili istasyon numarası gösterilir ve istasyon numarası yanıp söner. Diğer bir programa geçmek için program  tuşuna basabilirsiniz.
3.  veya  tuşlarına basarak istasyon çalışma süresini değiştirebilirsiniz. İstasyon çalışma süresi 0 ile 4 saat arasında ayarlanabilir.
4. Diğer istasyona geçmek için  tuşuna basabilirsiniz.



Sulama Günlerini Seçme

1. Kadranı **SULAMA GÜNLERİ** pozisyonuna getirin.
2. Ekranda en son seçili program (A, B veya C) gösterilir.  tuşuna basarak diğer bir programa geçebilirsiniz.
3. Ekranda haftanın yedi günü (PZT, SAL, ÇAR, PER, CUM, CMT, PAZ) gösterilir. Her bir günde  damla ya  da üstü çizili damla simgesi bulunur. Damla sulama olacağını, üstü çizili damla sulama olmayacağını temsil eder.



SULAMA GÜNLERİ

KONTROL ÜNİTESİNİN PROGRAMLANMASI

Sulamamın Yapılacağı Haftanın Belli Günlerini Seçme

- Seçili günde (her zaman PZT ile başlar) **+** tuşuna basıldığında haftanın o gününe ait sulama aktive edilir. **-** tuşuna basıldığında ise o güne ait sulama iptal edilir. Herhangi bir tuşa basıldığında otomatik olarak bir sonraki güne geçilir.



- Tüm istenen günleri seçinceye kadar 1. adımı tekrarlayın. Seçili günlerde sulama yapılacaksa sistemin Açık olduğunu işaret eden damla simgesi gözükür. Son görülen damla işareti ise bu hafta için programın son sulama gününü gösterir.

Sulamada Tek veya Çift Günleri Seçme

Bu özellik haftanın belli günleri yerine ayın günlerinin (tek günler: 1, 3, 5 vb; çift günler: 2, 4, 6 vb.) sulama için seçilmesine olanak tanır.

- Gösterge PAZ'nun üzerine gelene kadar, **▶** sağ oka basınız.
- Sağ oka bir kez daha bastığınızda, yağmur damlası ikonu ile birlikte ODD (tek günler) seçimi görünür. Tek günleri seçmek istiyorsanız kadrani Başlat konumuna geri getirin.
- Çift günlerde sulama isteniyorsa, **-** tuşuna basınız. Damla ikonu ve **EVEN (Çift günler)** yazısı belirecektir. **-** tuşuna basarak **TEK** ve **ÇİFT** arasında gidip gelebilirsiniz.



NOT: Her ayın 31. günü ve Şubat ayının 29'u eğer tek günlerde sulama seçildiyse sulama yapılmayacak günler olarak tasarlanmıştır.

Aralıklı Sulama Seçimi

Bu seçenek ile 1 ile 31 gün arasında aralıklı sulama günü seçebilirsiniz.

- ÇİFT** seçiliyken **▶** tuşuna beraber basarak  simgesini aktive edin. Aralıklı sulama takvimi ekranda belirir. Sulama günleri arasındaki gün sayısını gösteren 1 yanıp sönecektir.
- +** veya **-** tuşlarına basarak sulama günleri aralığını (1 ile 31 gün arasında) belirleyin. Bu aralık olarak adlandırılır.



Kontrol ünitesi ilk sulama başlangıcında seçili sulama programını uygulayacak ve daha sonra programlanan sulama aralığını uygulayacaktır.





Not: Interval (aralıklı günler) modundan çıkmak için (gerekmiyorsa) Haftanın Günleri tekrar ekranda görüntülenene kadar sol ok düğmesine basın.

Belirli Gün(ler)de Sulamayı Kapatma

X-Core sulamanın kapatılacağı günleri belirlemenize olanak tanır. Bu özellik sulamanın belirlenen gün(ler)de yapılması istenmiyorsa kullanılır. Örneğin, çimleriniz Cumartesi günleri düzenli olarak biçiliyorsa Cumartesi gününü **Sulamamız Gün** olarak tayin ederek, ıslak çimleri biçmeye çalışmak zorunda kalmazsınız.

- Kadrani **SULAMA GÜNLERİ** pozisyonuna getirin.
- Sayfa 19'da açıklandığı gibi bir sulama aralığı girin.
- ▶** tuşuna basarak ekranın alt kısmında bulunan **Sulamamın Kapatılacağı Günler** bölümüne gelin. Şu an **PZT** yanıp sönecektir.
- ▶** tuşuna basarak, sulamanın yapılmasını istemediğiniz günü aktif hale getirin.

KONTROL ÜNİTESİNİN PROGRAMLANMASI

5.  tuşuna basarak bulunduğunuz günü sulama yapılmayacak.  gün olarak belirleyin. Üzeri çizli damla simgesi ekranda gözükülecektir.
6. İsteddiğiniz gün(ler)i belirleyinceye kadar 4. ve 5. adımları tekrarlarlayın.



NOT: Tek ve Çift günlerde sulamayı kapatmayı programlama imkanı aralıklı sulma takviminde opsiyon olarak vardır.

Otomatik Sulama

X-Core'u programladıktan sonra kadranı **BAŞLAT** pozisyonuna getirmek tüm seçili sulama programlarının ve başlangıç zamanlarının çalışmasını sağlar.

SİSTEM KAPALI

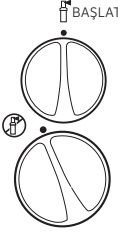

Sistemin Kapatılması

Sulama yapan vanalar kadran **SİSTEM KAPALI** konumuna getirildikten 2 saniye sonra kapanır.



Tüm aktif programlar devam ettirilmez ve sulama durdurulur. Kontrol ünitesinin tekrar normal otomatik fonksiyonlarına geri döndürmek için kadranı **BAŞLAT** pozisyonuna geri getirin.

Programlanabilir Yağmur Durdurması

Bu özellik kullanıcıya tüm programları 1 ile 7 gün arasında durdurma seçeneği sağlar. Yağmur durdurması periyodunun bitiminde kontrol ünitesi normal otomatik çalışmasına devam eder.

1. Kadranı **SİSTEM KAPALI** pozisyonuna getirin. **OFF** yazısının belirmesini bekleyin.
2.  tuşuna istenilen gün sayısına (en fazla 7 gün) ulaşıncaya kadar basın.





3. Kadranı tekrar **BAŞLAT** pozisyonuna geri getirdiğinizde ekranda **OFF**, bir sayı,  ve  simgeleri belirecektir.

Her gece yarısında kapalı gün sayısı azalacaktır. Sıfır belirlediğinde ekranda o günün normal zamanı ve normal sulaması bir sonraki programlanan takvime gününe göre aktive olacaktır.

Mevsimsel Ayarlama %

Mevsimsel Ayarlama, kontrol ünitesinin tamamının yeniden programlanmadan, temel çalışma sürelerinin değiştirilmesini sağlar. Mevsimsel Ayarlama özelliğinin kullanılması için:

1. Kadranı **MEVSİMSEL AYARLAMA** pozisyonuna getirin.
2. Ekranda sürekli görülen çizgilerin yanı sıra % işaretinin yanında yanıp sönen değer olarak bir rakam belirecektir.  veya  tuşlarına basarak mevsimsel ayarlama yüzdesini değiştirebilirsiniz. Ekrandaki her çizgi %10 değerini temsil eder. Bu özellik sayesinde orijinal programı %10 - %150 değerleri arasında değiştirebilirsiniz.

MEVSİMSEL AYARLAMA %



Uyarlanmış çalışma zamanlarını görmek için kadranı **ÇALIŞMA SÜRELERİ** pozisyonuna çevirin, ekranda beliren çalışma zamanı yapılan mevsimsel ayara göre yenilenecektir.



NOT: Kontrol ünitesinin ayarları başlangıçta %100 değerine göre ayarlanmalıdır.

KONTROL ÜNİTESİNİN PROGRAMLANMASI

Hunter “Clik” hava sensörü kullanılırken Mevsimsel Ayarlama değeri aşağıda açıklandığı şekilde yapılabilir.

Solar Sync ET Sensörü kullanılırken Mevsimsel Ayarlama değeri otomatik olarak Solar Sync sensöründen alınan verilere göre günlük olarak yenilenir. Solar Sync ET sensörü hava durumu koşullarını ölçer, en uygun Mevsimsel Ayarlamayı belirler ve kontrol ünitesini günlük olarak güncelleştirir. Bu değer manuel olarak **+** veya **-** tuşları ile istenilen mevsimsel ayar değerini eskisini geçerli kılmayacak şekilde değiştirilmesine izin verir. **Ne var ki, manuel olarak değiştirilen Mevsimsel Ayarlama değeri Solar Sync sensöründen geceyarısı gelecek yeni değer ile değiştirileceğini unutmamak gerekmektedir.**

Manuel moda geri dönmek için Solar Sync sensörü mutlaka sistemden sökülmelidir. Sayfa 14’te yer alan bilgiler Solar Sync sensörünün nasıl söküleceğini anlatmaktadır.

Tek İstasyonu Manuel Çalıştırma

1. Kadranı **MANUEL TEK İSTASYON** konumuna çevirin.
2. İstasyon çalışma zamanı ekranda yanıp sönmektedir. **▶** tuşunu kullanarak istenilen istasyonu seçin. **+** veya **-** tuşlarını kullanarak istasyonun sulama yapmasını istediğiniz süreyi girebilirsiniz.
3. Kadranı, istasyonu (sadece ayarlanan istasyon çalışacak, daha sonra kontrol ünitesi daha önceden ayarlanan programlarda bir değişiklik olmadan otomatik sulama moduna dönecek) çalıştırmak için tekrar saat yönünde BAŞLAT pozisyonuna getirin. Ayrıca **Tek Tuşla Manuel Başlatma ve İlerleme** konusunu da inceleyin.

MANUEL TEK
İSTASYON 



Tek Tuşla Manuel Başlatma ve İlerleme

Kadranın konumunu hiçbir şekilde değiştirmeden tüm istasyonları aktive edebilirsiniz.

1. **▶** iki saniye boyunca basılı tutun.
2. Diğer programlara geçmek için **PRO** tuşuna basın.
3. İstasyon numarası yanıp sönmektedir. **▶** tuşuna basarak istasyonlar arasında gezilebilir, **+** veya **-** tuşlarıyla istasyon çalışma sürelerini (eğer birkaç saniye içinde 2. ve 3. adımlarda herhangi bir işlem yapılmazsa sulama kendiliğinden başlar) ayarlayabilirsiniz.
4. **▶** tuşuna basarak başlamasını istediğiniz istasyonu belirleyiniz. 2 saniyelik beklemeden sonra program çalışmaya başlayacaktır. Manuel çalışma sırasında herhangi bir anda **◀** veya **▶** tuşlarıyla istasyonlar arasında manuel geçiş yapabilirsiniz.

GELİŞMİŞ ÖZELLİKLER

Programlanabilir Sensör Atlatma

X-Core, kullanıcıya sensörlerin sadece istenilen istasyonlardaki sulamayı kesmesi için imkan verir. Örneğin teras bahçelerindeki cumba ve çatılarında bulunan boşluklar yağmur suyunu alamayabilirler ve yağmurlu havalarda bile sulamaya ihtiyaç duyulabilir. Sensör atlatmayı programlamak için:

1. Kadranı **BAŞLAT** pozisyonuna getirin.
2. Kadranı **BAŞLANGIÇ ZAMANLARI** pozisyonuna getirirken **+** tuşuna basılı tutun.
3. Basılı tuşunu bırakın, bu esnada ekranda istasyon numarası, ON yazısı ve şemsiye ikonu görülecektir.
4. **+** ve **-** tuşlarını kullanarak gösterilen istasyon için sensörü etkin yada pasif.
ON = Sensör aktif (sulamayı keser)
OFF = Sensör pasif (sulama yapılır)
5. **◀** veya **▶** tuşlarını kullanarak sensör atlamayı programlayacağınız diğer istasyonlara geçebilirsiniz.



SENSÖR AÇIK



SENSÖR KAPALI



NOT: Kontrol ünitesinin varsayılan ayarları yağmur yağdığıında tüm istasyonları kapatacak şekildedir.

X-Core sensörden sulamayı kesmesi için bir işaret aldığıında, ekranda sensörü atlatılacak şekilde programlanmış istasyonların numarası görülür. Sensörü atlatıp çalışan istasyon aktifse ekranda **☀** ve **☔** simgeleri beraber söyner.

Tüm İstasyonları Test Etme

X-Core kullanıcıların bir nevi test programı çalıştırmalarına olanak tanır. Bu özellik her istasyon için küçükten büyüğe numara sırasınada çalışır.

1. Kadran **BAŞLAT** konumunda olduğunda, **⏸** tuşuna basın ve basılı tutun. İstasyon sayısı belirecek ve iki saniye için süre yanıp sönecektir.
2. **+** ve **-** tuşlarını 1 – 15 dakika ayarlayacak şekilde sadece bir kez girin.
3. 2 saniyelik bir aradan sonra test programı başlayacak.

Hunter Quick Check™ Kolay Kontrol Özelliği

Bu özellik kontrol ünitesindeki kabloloma hatalarını bulmanıza olanak tanır. Sahada tüm kablolamayı tek tek kontrol etmek yerine, Hunter Quick Check devre kontrolünü kullanabilirsiniz. Quick Check test prosedürüne başlamak için:

1. **◀**, **▶**, **+**, ve **-** tuşlarına beraberce basın. Ekranda tüm bilgiler gözükecektir.
2. **+** butonuna basarak Quick Check prosedürünü başlatın. Birkaç saniye sonra devreleme hatalarına karşı tüm istasyonlar taranır. Kabloda her türlü kısa devre farkedildiğinde ekranda ERR sembolü ve istasyon numarası belirir. Hızlı kontrolün tamamlanmasından sonra kontrol ünitesi otomatik sulma moduna döner.

GELİŞMİŞ ÖZELLİKLER

Easy Retrieve™ Kolay Erişilebilir Hafıza

X-Core istenilen sulama programını hafızasında tutarak daha sonra geri çağırılmasına olanak tanır. Bu özellik kontrol ünitesinin orijinal ve istenilen ayarlara resetlenmesi/yeniden kurulması için hızlı bir yöntemdir.

Programı hafızaya kaydetmek için

1. Kadranı **BAŞLAT** pozisyonuna getirin **PRG** ve **PRG** tuşunu 5 saniye boyunca basılı tutun. Ekran mevcut programın kalıcı hafızaya kaydediliyor olduğunu işaret eden soldan sağa hareket eden 3 kesik çizgi gösterecektir.
2. Tüm tuşları bırakın.

Daha önceden kaydedilmiş programı hafızadan çağırmak için.

1. Kadranı **BAŞLAT** pozisyonuna getirin **PRG** ve **PRG** tuşunu 5 saniye boyunca basılı tutun. Ekran mevcut programın kalıcı hafızaya kaydediliyor olduğunu işaret eden sağdan sola hareket eden 3 kesik çizgi gösterecektir.
2. Tüm tuşları bırakın.

Programlanabilir İstasyonlar Arası Gecikme

Bu özellik bir istasyon kapanıp diğer istasyon açılmadan önce belli bir süre bekleme süresi girilmesine izin verir.

1. Kadranı **BAŞLAT** pozisyonuna getirin.
2. Kadranı **ÇALIŞMA SÜRELERİ** pozisyonuna getirirken **PRG** tuşunu basılı tutun.

3. **PRG** tuşunu bırakın. Bu esnada ekranda istasyonlar arasındaki gecikme süresi yanıp söner bir şekilde saniye olarak belirecektir.
4. 0 saniyeden 4 saate kadar gecikme süresini arttırıp azaltmak için **PRG** veya **PRG** tuşlarına basın .
5. Kadranı **BAŞLAT** pozisyonuna geri getirin.

Hafızanın Temizlenmesi / Kontrol Ünitesinin Resetlenmesi

Kontrol ünitesini yanlış programladığınızı düşünüyorsanız, kontrol ünitesine girilmiş tüm program ve bilgilerin silinerek hafızanın fabrika ayarlarına geri getiren işlemi kullanabilirsiniz.

1. **PRG** tuşunu basılı tutun.
2. **PRG** tuşunu basılı tutarken 3 saniye süresince RESET tuşuna basın ve sonrasında RESET tuşunu bırakıp **PRG** tuşuna basmaya devam edin.
3. **PRG** tuşuna ekranda saat görününe dek basılı tutmaya devam edin. (bu yaklaşık 8 saniye sürecektir)

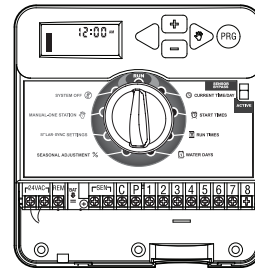

Resetle

CLIK GECİKME HAKKINDA BİLGİLER

Clik Gecikme Özelliği

Bu özellik, bir Clik Sensör Olayı bittikten SONRA kullanıcının belirli bir süre için (1-7 gün arası) programlanmış sulamayı geciktirmesine olanak sağlar. Programlanmış Clik Sensör Gecikme süresinin sonunda, kontrol ünitesi normal otomatik sulamasına yeniden başlayacaktır.

1. Kadranı **BAŞLAT** konumuna getirin
2. “+” tuşuna basın ve 3 saniye için basılı tutun, sonra kadranı Kapalı konumuna getirin
3. “+” tuşunu bırakın. Ekran programlanabilir Clik Gecikmeyi gösterecektir.



4. Clik Gecikme süresini belirlemek için “+” tuşuna basın. (1-7 gün arası)
5. Kadranı tekrar **BAŞLAT** konumuna getirin. Clik Gecikme kurulmuştur.

Clik Sensör Olayı bittikten sonra (yağmur sensörü ıslaktan kuruya geçer) Clik Gecikme özelliği aktif olacak ve ekran Clik Gecikme süresini belirtecektir. Geri gün sayımı, Clik Gecikme başladıktan 24 saat sonra gerçekleşecektir.



Aktif bir Clik Gecikme kadran **Kapalı** konumuna getirilerek, **OFF** yazısının yanıp sönmesinin durması beklenerek ve sonrasında kadran tekrar **BAŞLAT** konumuna getirilerek iptal edilebilir.

Sensörü baypas etmesi için ayarlanmış herhangi bir istasyon veya Aydınlatma Programları, Clik Gecikme esnasında çalışacaktır.



NOTE: Programlanabilir Clik Gecikmesi özelliğini Hunter Wind-Clik, Freeze-Clik, Soil-Clik, Solar Sync'in don komponenti ve Rain/Freeze Clik ile birlikte kullanırken dikkatli olun; çünkü Clik Gecikmesi bu cihazlarda Clik Olayından SONRA aktif-leşecek ve cihazların çalışmasını durdura-caktır.

GİZLENMİŞ ÖZELLİKLER

Program Özelleştirme

X-Core, üç bağımsız program (A, B, C) ve her farklı bitki türünün ihtiyacına göre dört başlangıç zamanı ile fabrikada yapılandırılmıştır. X-Core, tek program ve tek başlangıç zamanı göstermek üzere özelleştirilebilir, böylece gerekli olmayan ilave programlar ve başlangıç zamanları gizlenerek programlama kolaylaştırılabilir.

1. Ekran **RUN** (Çalıştır) konumunda olmalıdır.
2. - tuşuna basın ve basılı tutun. Kadranı **WATER DAYS** (Sulama Günleri)'e çevirin.
3. - tuşunu bırakın.
4. Program modlarını değiştirmek için + ve - tuşlarını kullanın.

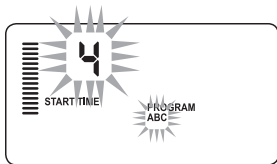

Normal Mod
(3 program / 4 başlangıç zamanı)

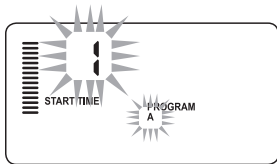

Limitli Mod
(1 program / 1 çalışma zamanı)

GİZLENMİŞ ÖZELLİKLER (DEVAMI)

Döngü ve Islatma

Döngü ve Islatma özelliği istasyon çalışma sürelerini daha kullanışlı, kısa sulama sürelerine böler. Bu özellik suyu eğimli ve killi topraklara uygularken suyu otomatik olarak daha yavaş vererek oluşabilecek göllenmeye engel olduğundan kullanışlı olur. Döngü zamanı olarak istasyonun sulama süresinin ayrılacağı süreleri ve Islatma için bir diğer döngünün başlamasından önce geçmesi gereken minimum süreyi belirlemelisiniz. Döngü için gerekli toplam süre, programlanan istasyon çalışma süresi döngü sayısına bölünerek elde edilir.

Döngü ve Islatma Menüsüne Erişim:

Döngü ve Islatma özelliğine kadran **BAŞLAT** konumundayken,

+ tuşuna 3 saniye boyunca basılı tutup kadranı **Çalışma Süreleri** konumuna çevirip basılı tutulan tuş bırakılarak ulaşılır.

Döngü Zamanının Ayarlanması:

Öncelikle 1. İstasyon gösterilir. Diğer istasyonlara ulaşmak için ◀ veya ▶ tuşlarını kullanın.

İstenen istasyon gösterildiğinde, **+** veya **-** tuşlarını kullanarak Döngü zamanını arttırabilir veya azaltabilirsiniz. Kullanıcı zamanı 1 dakika ile 4 saat arasında 1'er dakikalık arttırmalarla ya da Döngü belirlemek istemiyorsa **KAPALI** konumunda ayarlayabilir.



NOT: 1 saatten önce sadece dakikalar (örn. 36) gösterilir. 1 saat veya üzerinde ekran saat hanesini de gösterecek şekilde (örn 1:13 ve 4:00) değişecektir. Eğer istasyon Çalışma Süresi Döngü zamanından kısa ya da eşitse hiçbir Döngü uygulanmaz.

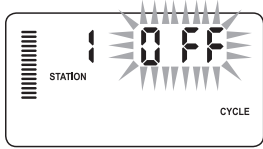

Giriş yapıldığında görünen Döngü ekranı örneği

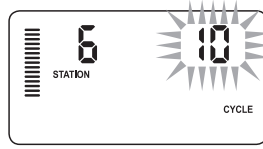

Sadece dakika içeren Döngü ekranı örneği

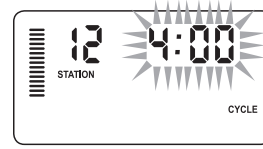

Saat içeren Döngü ekranı örneği

GİZLENMİŞ ÖZELLİKLER (DEVAMI)

Islatma Menüsüne Erişim:

Her bir istasyon için İstenen Döngü zamanı programlandığında, Döngü zamanına **PRO** tuşuna basılarak ulaşılabilir.

İstasyon daha önceden Döngü menüsü altında gösterildiği şekilde aynı (örn. eğer Döngü menüsü altında 2. istasyon gösteriliyorsa **PRO** tuşuna basıldığında yine 2. istasyon gösterilir) kalır.



NOT: Programlanmış Döngü zamanı olmadan Islatma menüsüne ulaşamaz.

Islatma Zamanını Ayarlama:

Diğer istasyonlara ulaşmak için ◀ veya ▶ tuşlarını kullanın



NOT: İstasyonları değiştirirken eğer Döngü zamanı girilmeyen bir istasyonla karşılaşırsa ,ekran direkt olarak döngü zamanına geri döner. Döngü zamanı bulunan diğer bir istasyona geçin ve **PRO tuşuna basarak geri dönün.**

İstenen istasyon gösterildiğinde kullanıcı **+** veya **-** tuşlarını kullanarak Islatma zamanını arttırıp azaltabilir. Kullanıcı Islatma zamanını 1 dakika ile 4 saat arasında 1 dakikalık arttırmalarla ayarlayabilir.



NOT: 1 saatten önce sadece dakikalar gösterilir (örn. 36). 1 saat ve sonrasında ekran saat hanesi de gösterilecek şekilde değişir (örn. 1:13 ve 4:00).

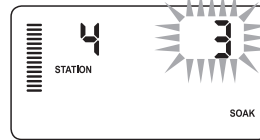

Sadece dakika içeren Islatma ekranına örnek

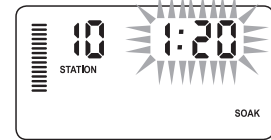

Saat içeren Islatma ekranına örnek

Döngü ve Bekletme Durumları:

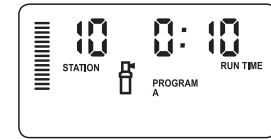

istasyonun 20 dakikalık bir sulamaya ihtiyacı var ancak 5 dakikadan sonra yüzey akışı meydana gelmektedir. 10 dakika sonra ise su absorbe edilmiş olacaktır. Çözüm istasyon çalışma süresini 20 dakika olarak ayarlamak olacaktır, Döngü zamanına 5 dakika ve Islatma (bekleme) zamanına da 10 dakika vermektir.

Islatma zamanı minimum süredir. Kalan çalışma sürelerine bağlı olarak ıslatma zamanı daha uzun olabilir.



10. istasyon döngüsü çalışıyor

ARIZA VE SORUN GİDERME REHBERİ

Problem	Nedeni	Çözüm
Kontrol ünitesi sürekli sulama yapıyor	Çok fazla başlangıç zamanı girilmiş	Bir programı başlatmak için tek bir başlangıç zamanı belirlemek yeterlidir. (sayfa 18'deki Program Başlangıç Zamanlarının Ayarlanması konusuna bakınız)
Ekran görüntü yok	AC kablomayı kontrol edin	Hataları giderin
Ekran "Güç Yok" yazıyor	Aktif bir elektrik kaynağı yok (kontrol ünitesine güç gelmiyor)	Adaptör bağlantısının doğru yapıldığını kontrol edin
Ekran "Kapalı   " yazıyor	Yağmur sensörü sulamayı kapatıyor ya da sensör jumperi-atlatma kablosu çıkarılmış	Yağmur sensörü bypass tuşunu devreyi iptal etmesi için kaydırın veya jumperi-atlatma kablosu tekrar takın
Yağmur sensörü sistemi kapatmıyor	<ul style="list-style-type: none"> Arızalı yağmur sensörü Sensör takıldığında jumper-atlatma kablosu sökülmemiş İstasyon sensörü atlayacak şekilde programlanmış 	<ul style="list-style-type: none"> Yağmur sensörünün ve kablolamasının doğruluğu kontrol edin Jumperi sensör terminallerden sökün Sensörü aktifleştirmek için sensör atlamayı yeniden programlayın (sayfa 11)
Ekran dondu ya da hatalı bilgiler yazıyor	Elektriksel baskı	Sayfa 24'de "Kontrol Ünitesinin Hafızasının Silinmesi" bölümünde anlatıldığı gibi resetleme yapın
Ekran "ERR" ve yanında rakam (1 ile 8 arasında) beliriyor ise	Vana bağlantılarında kısa devre veya belitilen istasyon numarası solenoidinde sorun olduğunu işaret eder	Kablo bağlantılarını ya da numarası yazan istasyonun solenoidini kontrol edin. Devreyi düzeltin ya da solenoidi değiştirin. Ekrandaki "ERR" uyarısını silmek için herhangi bir tuşa basın.
Ekran "P ERR" yazıyor	<ul style="list-style-type: none"> Pompa rölesi ya da ana vana kablolaması hatalı Uyumsuz ya da arızalı röle ya da solenoid Pompa rölesi veya ana vana için standartların dışında bir kablolama yapılmış 	<ul style="list-style-type: none"> Röle ve ana vana solenoid kablolarını kontrol edin. "P ERR" uyarısını silmek için bir tuşa basın Pompa rölesinin elektriksel özelliklerini kontrol edin. Kontrol ünitesinin elektrik değerinin üzerine çıkmayın. Eğer arızalı ise değiştirin Kabloyu daha güçlü bir kablo ile değiştirin

ARIZA VE SORUN GİDERME REHBERİ

Problem	Nedeni	Çözüm
Ekranda istasyonun çalıştığı görülüyor ancak sulama simgeleri ekranda yanıp sönüyor	Sensör sulamayı engelliyor fakat istasyon sensörü atlayacak şekilde programlanmış	Sensör atlama durumunu inceleyin (sayfa 23)
Otomatik sulama başlangıç zamanı geldiği halde başlamıyor ve kontrol ünitesi Sistem Kapalı surumunda değil	<ul style="list-style-type: none"> • AM/PM değerleri doğru girilmemiş • AM/PM başlangıç zamanları doğru girilmemiş • Başlangıç zamanı aktif değil(kapalı) • Kontrol ünitesine güç kaynağından elektrik gelmiyor 	<ul style="list-style-type: none"> • AM/PM saatini düzeltin • AM/PM başlangıç zamanını düzeltin • Başlangıç zamanlarının nasıl programlandığını inceleyin (sayfa 18) • AC bağlantılarını kontrol edin
Kadran Solar Sync ayarlama pozisyonundayken ekranda kısa çizgiler gözüküyor	<ul style="list-style-type: none"> • Solar Sync sensörün kontrol ünitesiyle bağlantısı yok • Solar Sync sensörünün bağlantı kabloları kopuk ya da hatalı bağlanmış 	Solar Sync'i kontrol ünitesindeki "SEN" terminaline bağlağın. Ekranda Bölge ve Su Düzeyi Ayarı görülecektir.
Solar Sync kullanılırken belirli bir istasyon için çalışma zamanları çok kısa ya da uzun oluyor	Program çalışma zamanı çok kısa ya da uzun ayarlanmış	Solar Sync kontrol ünitesine genel bir mevsimsel ayarlama uygular. Eğer belirli bir istasyonun çalışma süresi çok uzun ya da çok kısaysa programa uygun ayarlamayı yapmak gerekir. Program çalışma zamanlarını değiştirmeden önce mevsimsel ayarı %100 değerine getirmeyi unutmayın. Bu işlemi kadranı Mevsimsel Ayarlama pozisyonuna getirip %100 değerine ulaşıncaya kadar arttırıp azaltarak yapabilirsiniz.
Mevsimsel Ayarlama düşük gözüküyor	<ul style="list-style-type: none"> • Bölge çok yüksek seçilmiş • Su Düzeyi ayarı çok düşük • Sensörün konumu güneş ışığını tam olarak alamayacak noktada bulunuyor 	Su Düzeyi ayarını (varsayılan ayar 5) yükseltin. Eğer Su Düzeyi'ni maksimum 10 değerine kadar yükselttiğiniz halde hala mevsimsel ayarlamayı arttırmanız gerekiyorsa bir alt bölgeye geçin (örneğin 4'den 3'e) ve Su Düzeyi ayarının 5 değerinden başlatın. Solar Sync hemen kontrol ünitesini güncelleştirecektir. Eğer halen çok yüksekse yukarıdaki adımları istenilen mevsimsel ayar sağlanıncaya kadar tekrarlayın.

ARIZA VE SORUN GİDERME REHBERİ

Problem	Nedeni	Çözüm
Mevsimsel Ayarlama yüksek gibi	<ul style="list-style-type: none"> • Bölge çok düşük seçilmiş • Su Düzeyi ayarı çok yüksek 	Su Düzeyi ayarını düşürün. Eğer Su Düzeyi'ni 1 değerine kadar düşürdüğünüz halde hala mevsimsel ayarı arttırmamız gerekiyorsa bir üst bölgeye geçin (örneğin 2'den 3'e) ve Su Düzeyi ayarının 5 değerinden başlatın. Solar Sync hemen kontrol ünitesini güncelleştirecektir. Eğer halen çok yüksekse yukarıdaki adımları istenilen mevsimsel ayar sağlanıncaya kadar tekrarlayın.
Solar Sync kontrol ünitesindeki sensör atlama tuşu açık olduğu halde Mevsimsel Ayarlamalar gönderiyor	Solar Sync'in otomatik Mevsimsel Ayarlama atlama tuşu ile kapatılamaz. Atlama tuşu sadece Solar Sync'in yağmur/don sensör özelliklerini kapatır.	
Solar Sync sensör kontrol ünitesinden çıkarıldığı halde mevsimsel ayarlama elle değiştirilemiyor	Solar Sync sensör sürekli kullanılmayacaksa kontrol ünitesinden sökülmelidir	Solar Sync sensörü çıkardıktan sonra kadranı Solar Sync Ayarları'na getirin. Ekranda çizgiler görülecektir. Sensör şimdi kaldırılmıştır. (Bknz Sayfa 14)
Ekranda "no SS" beliyor	<ul style="list-style-type: none"> • Solar Sync sensörünün kontrol ünitesi ile bağlantısı kesilmiş ancak sökülmemiş • Solar Sync sensörü hatalı bağlanmış 	<ul style="list-style-type: none"> • Solar Sync sensör ile kontrol ünitesi arasındaki bağlantıyı kontrol edin • Solar Sync sensörü sökün, sorun devam ediyorsa kontrol ünitesinden tamamen kaldırın (Bknz Sayfa 14)

TEKNİK ÖZELLİKLER

İşletme Özellikleri

- İstasyon Çalışma Süreleri: 0 ile 4 saat arası 1'er dakikalık arttırmımlarla
- 3 Bağımsız Sulama Programı
- Başlangıç Zamanları: Her program başına günde 4 adet olmak üzere 12 başlangıç zamanı
- Sulama Takvimi: 365 günlük takvim, aralıklı sulama, tek/çift gün sulaması
- AM/PM, 24 saat
- Basit manuel kullanım
- İstasyonlarda sensör atlama
- Ayarlanabilir yağmurlama erteleme (1 ile 7 gün arası)
- Manuel Mevsimsel Ayarlama (%10 ile %150 arası)
- Solar Sync sensörünü kullanarak Otomatik Mevsimsel Ayarlama
- Sensör bypass /atlatma tuşu
- X-Core-x00i iç mekan, X-Core-x00 dış mekan kullanımı
- -25° C - 60° C sıcaklık arasından deniz seviyesinden 2000m'ye kadar

Ölçüler

İç Mekan Kabin

- Yükseklik: 16,5 cm
- Genişlik: 14,6 cm
- Derinlik: 5 cm

Dış Mekan Kabin

- Yükseklik: 22 cm
- Genişlik: 17,8 cm
- Derinlik: 9,5 cm

Elektrik Özellikleri

- 230VAC \pm 10% 50/60 Hz Adaptör Girişi
- 24VAC 1.0 amper Adaptör Çıkışı
- İstasyon Başına 0,56 amper Çıkış
- 0,90 amper maksimum çıkış (ana vana dahil)
- Batarya: Uzaktan programlama ve saatin yenilenmesi için 3V Lityum (içerir). CR2032 3V pil kullanılmalıdır
- Elektronik kısa devre koruması
- Program bilgilerin kaybolmaması için kalıcı hafıza
- UL Listesinde
- X-Core-x00 IP2X Derecesi'ne sahiptir
- Sadece sabunlu hafif nemli bir bezle silinmelidir.

Simgelerin Açıklanması

~ = AC (Alternatif Akım)

⚠ = Dökümana Başvurun

⚡ = Tehlikeli Voltaj İçerir

⊕ = Topraklama

Hunter[®]

Hunter Industries Incorporated

1940 Diamond Street • San Marcos, California 92078 USA
www.hunterindustries.com

© 2018 Hunter Industries Incorporated

LIT-397 Multi G 8/18